

**Geochemical and Geophysical Report**  
**on the**  
**Tahte Property**  
**Comprised of the**  
**Suzi 1-127 claims**  
**(YC90721 – YC90794 and YF40429 – YF40481)**

NTS 115H10 and 15  
Whitehorse Mining Division  
Yukon Territory, Canada  
61°45'N Lat., 136°47'W Long.

Work Performed: July 12-22, 2013

On behalf of:

Cathro Resources Corp.  
2560 Telford Place  
Kamloops BC  
V1S 0A3 Canada

Report prepared by:

Michael S. Cathro, MSc, PGeo  
Cathro Resources Corp.

February 1, 2014

## 1.0 TABLE OF CONTENTS

2.0 Summary and Introduction .....	3
3.0 Claim Status.....	5
4.0 Project Location, Infrastructure and Land Status .....	5
5.0 Access.....	5
6.0 Regional Geology and Mineral Deposits .....	6
7.0 Previous Work.....	8
8.0 2013 Work Program .....	23
9.0 Results and Conclusions.....	25
10.0 Summary and Recommendations .....	27
11.0 Qualifications .....	39
12.0 References .....	40

### List of Figures

Figure 1. Location map of the Tahte property.....	13
Figure 2. Claim map of Tahte Property.....	14
Figure 3. Location of Tahte property in relation to other key deposits.....	15
Figure 4. Regional Geology of Tahte property .....	16
Figure 5. Maps of Tahte property with MINFILE and Regional stream sediments, etc.....	17
Figure 6. Location map of 2013 IP lines and rock and soil samples .....	29
Figure 7. Map of Au in soil (2010 to 2013 samples) .....	30
Figure 8. Map of Cu in soil (2010 to 2013 samples).....	31
Figure 9. Map of Mo in soil (2010 to 2013 samples).....	32
Figure 10. IP Inversions for Line 700N.....	33
Figure 11. IP Inversions for Line 1200N.....	34
Figure 12. IP Inversions for Line 2700N.....	35
Figure 13. 2014 IP chargeability anomalies, overlain on 1977 Noranda chargeability map .....	36
Figure 14. 2014 IP chargeability anomalies, overlain on 1977 Noranda resistivity map .....	37
Figure 15. 2014 IP chargeability anomalies, overlain on GSC aeromagnetic total field.....	38

### List of Tables

Table 1. List of Claims, Tahte Property .....	9
Table 2. 2010 Drill Core Assays of Re-sampled 1980 Noranda Drill Holes.....	21

### List of Appendices

Appendix 1. Soil and Rock Sample Descriptions and Results for Key Elements.....	41
Appendix 2. Laboratory Certificates .....	44
Appendix 3. Report on Induced Polarization Surveying by Peter E. Walcott and Associates.....	60

## 2.0 SUMMARY AND INTRODUCTION

The Tahte property, comprising the Suzi 1-127 claims, covers an historic porphyry Cu-Au-Mo prospect known as Tahte or Tah (MINFILE # 115H 038). The property is located 43 km southwest of the village of Carmacks in southwest Yukon, and is within 36 km of the Klondike Highway and grid power. The prospect was originally discovered by Noranda Exploration Company Limited, which completed limited mapping, induced polarization (IP) and magnetic surveys in 1977, and drilled three short holes in 1980.

The core of the property was re-staked by Cathro Resources Corp. in September of 2009. A small program of prospecting, soil and silt sampling, and drill-core resampling was completed in summer and fall of 2010 and was successful in confirming the presence of anomalous Au, Cu and Mo values in the historic Noranda drill core (Tahte zone). In addition, a new zone of quartz-molybdenum mineralization, called the “Ribbon zone” was discovered in intrusive rock some 1.4 km northwest of the Noranda holes. Additional claims were staked in August 2012 to cover possible extensions of the Ribbon zone.

This report describes a program of IP surveying, soil sampling and limited prospecting completed in July 2013. Prospecting in 2013 (3 rock samples) was successful in locating two additional areas of quartz-molybdenite mineralization in the Ribbon zone and SW of the Tahte zone.

Soil sampling in 2013 (73 samples) extended the Mo in soil anomaly associated with the Ribbon moly zone to the E, and to the SE towards the Tahte zone. Additional test work is needed to identify the best approach for surficial geochemistry on north facing slopes with permafrost and thick loess. Techniques to try may include deep (2-3 m) sampling of the C-horizon soils by power auger, or selective extraction techniques on the A-horizon.

With respect to the Ribbon moly zone, compilation of prospecting and soil sampling results from 2010, 2012 and 2013 now shows that this zone has a strike length of 2200 m in a NW-SE direction, and a width of 500 to 700 m. Mo is the primary element of interest, however, soils also indicate that there are scattered Au values in places. The Ribbon moly zone may merge with the Tahte zone to the NE, and is it still open to the NW and E. The best assay to date is 4340 ppm Mo (or 0.72% MoS<sub>2</sub>). Additional prospecting and soil sampling is warranted along this trend.

The 2013 induced polarization survey comprised 9.1 km of surveying on three lines and identified several features of potential interest:

Chargeability anomaly cA is located in the Tahte zone area, and is associated with a moderate intensity resistivity feature at depth.

Chargeability anomalies cB and cC appear to be associated with lower resistivity, and given the elevated Cu and Au in soil geochemistry, may also be a viable target.

It can now be seen that the shallow Noranda drill holes TAH-01 and TAH-03, which intersected anomalous Au, Cu and Mo over their full lengths, may not have effectively tested the Tahte target. These holes appear to have been drilled in a relative chargeability low between the strong anomalies cA and cB. In addition, the best soil geochemistry occurs to the NE of hole TAH-03 in association with chargeability anomaly cB. Further evaluations of the anomalies in this area should be undertaken.

Chargeability anomaly cD is a weak, deeper chargeability feature, with associated strong Mo and weak Au in soil anomalies. Anomaly cD is also proximal to the subcropping Ribbon moly zone to the west, which is potentially associated with the intense resistivity high on the western end of this line.

The historic ground magnetic data shows a somewhat more complex pattern than observed in the GSC airborne survey. Additional ground mag should be undertaken over the entire area of interest. This data should then be compiled, and reviewed with the existing data. This would help guide in the planning of additional induced polarization surveying.

3D IP techniques should also be considered in the area surrounding anomaly cA-cC.

### 3.0 CLAIM STATUS

The Tahte property comprises the Suzi 1-127 quartz claims owned 100% by Cathro Resources Corp. (Table 1). The Suzi 1-74 claims were staked on September 29, 2009 and the Suzi 75 to 127 claims were staked on August 5, 2012.

### 4.0 PROJECT LOCATION, INFRASTRUCTURE AND LAND STATUS

The Tahte property is located 43 km southwest of the village of Carmacks in the Whitehorse Mining District (Figure 1). It occurs on NTS map sheets 115H10 and 15, and is centred at approximately 61°45'N Lat., 136°47'W Long. The target area lies at the head of Tahte Creek. Elevations range from approximately 1000 to 1500 m and tree line is at approximately 1350 m.

In terms of infrastructure, the project area lies 36 km due west of the Klondike Highway (#2) and the Yukon electrical grid. The Mt. Nansen mine road is located 27 km to the north and the Aishihik Lake road is 30 km southwest. Overall, the proximity to all-weather roads and the Yukon grid makes the Tahte area an attractive site for possible future mine development.

The project falls within the Nisling River Wildlife Reserve, a designation that does not restrict mineral exploration or mining. No parks or other restrictions are present in the area of the property.

The Tahte property lies within the shared traditional territories of the Little Salmon Carmacks and Champagne and Aishihik First Nations. A small “Category B” First Nations surveyed settlement area (LSC R-22B; Figure 2) is present to the northeast of Tahte property. A small number of the claims staked in 2012 partially overlap this designation (Suzi 83, 85, 91). Under the 1993 Final Agreement between the Governments of Canada and Yukon and the Little Salmon Carmacks First Nation, the First Nation “has ownership of surface to these Settlement Lands, but does not have ownership of Mines and Minerals nor the Right to Work Mines and Minerals”. Aboriginal title is retained by the First Nation in this category. The Government of Yukon retains administration and control of the sub-surface (i.e. mineral) lands. Similarly, the Government of Yukon retains administration and control of both the surface and subsurface of areas outside the Settlement Lands, including the Tahte property itself.

Several small blocks of competitor claims are present in the general area (Figure 2).

### 5.0 ACCESS

The Tahte project area (Figures 1, 2, 3, 4, 5) is accessible by helicopter from Carmacks (43 km) or Whitehorse (143 km). A rough road is reported to reach the placer claims located 21 east of the Tahte project (Figure 4).

## 6.0 REGIONAL GEOLOGY AND MINERAL DEPOSITS

### Regional Geology

The Aishihik sheet and the area of the Tahte property were mapped at a 250,000 scale by the GSC in the period 1970-73 (Tempelman-Kluit, GSC Map 17-1973). More detailed government mapping has not been completed since.

Tempelman-Kluit mapped two intrusive units of assumed Triassic age in the Tahte area; namely “Trgdm” and “Trqm”. Unit Trgdm is assumed to be slightly older and is described as “*Hornblende granodiorite: dark grey weathering, coarse-grained, equigranular biotite hornblende granodiorite to quartz diorite, commonly showing layering or foliation by alignment of mafics; includes pink quartz monzonite (Trqm) and porphyritic quartz monzonite (Mqmp undifferentiated)*”.

Unit Trqm is described as “*Pink quartz monzonite: pink coarse-grained leucocratic quartz monzonite and porphyritic pink quartz monzonite*”.

A small inlier of unit Tvr (Eocene or Younger) is shown by Tempelman-Kluit to be present on the Suzi claims, just to the west of Tahte prospect itself. This unit is described as “*varicoloured acid tuff; brightly weathered, light-weathering acid vitric crystal tuff, lapilli tuff and welded tuff, includes plugs and necks that are feeders to these extrusive rocks*”. This unit appears to be the same as the hornblende porphyry unit mapped by Noranda, which is now interpreted to be Upper Cretaceous Carmacks Group volcanics (unit uKC2 on Figure 5).

A more recent regional geological compilation is shown on the Yukon MapMaker website (Figures 4, 5). The area southwest of Carmacks is mainly underlain by volcanic and intrusive rocks of the Stikine Terrane. To the east, the Upper Triassic Whitehorse Trough consists of sedimentary and volcanic rocks laid down in a basinal environment. Intrusive rocks mainly fall into the Aishihik Suite (EJgA, foliated granodiorite, diorite and potassium feldspar granite; interpreted to be unit Trgdm of Tempelman-Kluit) and the Long Lake Suite (EJgL; felsic granite and mesocratic hornblende syenite; interpreted to be unit Trqm of Tempelman-Kluit).

Further to the north (Figure 3), the Aishihik Suite is host to important alkalic porphyry copper-gold deposits including Williams Creek and Minto. Northwest of Carmacks, the Long Lake Suite and Late Cretaceous intrusions are associated with important precious-metal enriched porphyry and epithermal vein-style deposits such as Nucleus, Revenue, Laforma and Mt. Nansen. Near Whitehorse, skarn deposits of the Whitehorse copper belt were mined historically.

### Regional Surficial Geology

The Tahte project area falls within the “pre-Read” glaciation limit (YGS MapMaker Online), and therefore, has not seen glaciation in approximately 3 million years. This would appear to match observations in drill core by Noranda (see below), which shows abundant oxidation down to several hundred feet depth in bedrock. YGS surficial

geologist Jeff Bond (personal communication) has also confirmed that in addition to deep weathering, soils in the area contain loess (windblown glacial silt) and volcanic ash layers, which can subdue the soil geochemical response. Permafrost can be present particularly on north-facing slopes. Deeper soil sampling was recommended.

### Regional Geochemistry

The area southwest of Carmacks contains numerous high Au values in government RGS stream sediments, ranging up to 1630 ppb (Figure 4). Several creeks in the immediate area of the Tahte project contain highly anomalous Au (844, 311, 64, 888 ppb) and Mo (16, 6, 3 ppm) values (Figure 5). Copper values in RGS silts are relatively subdued, however this could be related to deep weathering and oxidation.

### Regional Mineral Deposits

The Tahte project area lies in the southern portion of the Carmacks (Dawson Range) porphyry and epithermal belt, a particularly well-mineralized part of the Stikine Terrane (Figure 3). Recent work by the researchers at the Yukon Government, Geological Survey of Canada and Mineral Deposit Research Unit (MDRU) at the University of British Columbia has helped constrain the age, host rocks and geological controls on Au and base-metal mineralization in the region (Figure 3). The wide variety of styles and ages of mineralization include high-grade epithermal Au-Ag and polymetallic veins (e.g. Mt Nansen), skarns, bulk-tonnage epithermal Au-Ag (e.g. Mt. Freegold), mid to Late Cretaceous calc-alkaline porphyry Cu-Mo-Au-Ag (e.g. Casino), and Jurassic alkaline porphyry Cu-Au (e.g. Minto).

The Jurassic Minto alkalic Cu-Au-Ag porphyry deposit has been in production since October 2007. It is relatively high-grade and is hosted in a foliated granodiorite unit (part of the Aishihik Suite). As of December 31, 2012, measured and indicated resources were 51.627 million tonnes grading 1.11% Cu, 0.41 g/t Au, and 3.88 g/t Ag, and inferred resources were 16.199 million tonnes grading 0.92% Cu, 0.34 g/t Au, and 3.17 g/t Ag. The mill processed 1.4 million tonnes of ore in 2013 (Capstone Mining Corp. website and news release, January 13, 2014).

The Williams Creek (Carmacks Copper) deposit is located 50 km southeast of the Minto deposit, and 62 km north of the Tahte property. Williams Creek is also hosted by an Aishihik Suite foliated Jurassic granodiorite, and is reported to have measured and indicated resources totaling 11.98 million tonnes grading 1.07% total Cu, 0.456 g/t Au and 4.578 g/t Ag (Copper North Mining Corp. website, February 2013). The deposit is oxidized and according to an updated 2012 feasibility study, could be developed as an open-pit, heap-leach, solvent extraction - electrowinning copper-oxide operation.

The largest known porphyry deposit in Yukon is the Casino Cu-Au-Ag-Mo deposit. Casino consists of a well-developed supergene oxide cap underlain by a supergene sulphide zone and a hypogene zone. It is hosted by the late Cretaceous Patton porphyry, which intrudes the mid-Cretaceous Casino Plutonic Suite. The combined supergene and hypogene zones contain a measured and indicated resource totaling 1.057 billion tonnes grading 0.20% Cu, 0.23 g/t Au, 0.022% MoS<sub>2</sub> and 1.71 g/t Ag at a 0.25%

Cu equivalent cutoff grade. An inferred resource totals 1.696 billion tonnes grading 0.15% Cu, 0.16 g/t Au, 0.019% MoS<sub>2</sub>, and 1.37 g/t Ag at a 0.25% Cu equivalent cutoff grade. A heap leach oxide gold resource has also been outlined. A positive feasibility study was completed in early 2013, based on a 120,000 tonne-per-day open-pit/milling operation, and a 25,000 tonne-per-day gold heap-leach (Western Copper and Gold Corp. website, February 2013).

## 7.0 PREVIOUS WORK

The Tahte porphyry prospect (MINFILE 115H 038) was first explored by Noranda Exploration Company Limited in 1977 and 1980. This work is documented in two assessment reports (Fairbank et al., 1977; and Macdonald, 1980). The original claims were called Tah 1-42.

The 1977 work comprised line cutting, 12.76 line-miles of frequency domain dipole-dipole IP (n=1, 400'), 22.68 line-miles of ground magnetic surveying, and geological mapping over the grid area.

Noranda's geological mapping identified three phases of intrusive rocks as follows (from oldest to youngest):

*Hornblende Granodiorite:* coarse-grained, foliated, biotite hornblende granodiorite. Sulphides and hydrothermal alteration are absent. This unit is interpreted to be part of "Klotassin Suite" and the oldest rock in the area. It is probably equivalent to unit Trgdm of Tempelman-Kluit, which has been re-named as the "Aishihik Suite" and shown as EJgA on Figures 4 and 5.

*Quartz Monzonite:* deeply weathered, coarse-grained, leucocratic quartz monzonite. It invades the hornblende granodiorite with minimal contact effect. These rocks are described as being deeply weathered and composed mainly of quartz and partly decomposed feldspar. Iron oxides (limonite, jarosite) on surface suggest that pyrite may be present beneath the oxidation zone. Zones of kaolinite, sericite and silica alteration were noted on the western part of the grid. This unit would appear to be equivalent to unit Trqm of Tempelman-Kluit, and the Long Lake suite (Unit EJgL) on Figure 4 and 5.

*Feldspar Porphyry:* "crowded" feldspar +/- hornblende phenocrysts to 3 mm in medium to dark green fine-grained groundmass. Intrudes both quartz monzonite and hornblende granodiorite. The porphyry is interpreted to form a plug in the southern part of the property. This unit is weakly to strongly magnetic and locally contains pyrite and minor hematite. Weak to moderate propylitic alteration (chlorite, epidote, carbonate) has been mapped at several locations. It is considered to be younger than the other two units, and interpreted to be Tertiary (Eocene?) by the Noranda geologists because of its similarity to "Tertiary" porphyries known at Casino and Cash. This unit is now interpreted to be Upper Cretaceous Carmacks Group volcanics (unit uKC2 on Figure 5).

**Table 1. List of Claims**  
Tahte Property (Suzi 1 to 127 claims)  
Owned by Cathro Resources Corp.  
Whitehorse Mining District, Yukon

<b>Grant #</b>	<b>Claim Name</b>	<b>Claim #</b>	<b>Staking Date</b>	<b>Expiry Date</b>
YC90721	SUZI	1	09-09-29	18-09-30
YC90722	SUZI	2	09-09-29	18-09-30
YC90723	SUZI	3	09-09-29	18-09-30
YC90724	SUZI	4	09-09-29	18-09-30
YC90725	SUZI	5	09-09-29	18-09-30
YC90726	SUZI	6	09-09-29	18-09-30
YC90727	SUZI	7	09-09-29	18-09-30
YC90728	SUZI	8	09-09-29	18-09-30
YC90729	SUZI	9	09-09-29	18-09-30
YC90730	SUZI	10	09-09-29	18-09-30
YC90731	SUZI	11	09-09-29	18-09-30
YC90732	SUZI	12	09-09-29	18-09-30
YC90733	SUZI	13	09-09-29	18-09-30
YC90734	SUZI	14	09-09-29	18-09-30
YC90735	SUZI	15	09-09-29	18-09-30
YC90736	SUZI	16	09-09-29	18-09-30
YC90737	SUZI	17	09-09-29	18-09-30
YC90738	SUZI	18	09-09-29	18-09-30
YC90739	SUZI	19	09-09-29	18-09-30
YC90740	SUZI	20	09-09-29	18-09-30
YC90741	SUZI	21	09-09-29	18-09-30
YC90742	SUZI	22	09-09-29	18-09-30
YC90743	SUZI	23	09-09-29	18-09-30
YC90744	SUZI	24	09-09-29	18-09-30
YC90745	SUZI	25	09-09-29	18-09-30
YC90746	SUZI	26	09-09-29	18-09-30
YC90747	SUZI	27	09-09-29	18-09-30
YC90748	SUZI	28	09-09-29	18-09-30
YC90749	SUZI	29	09-09-29	18-09-30
YC90750	SUZI	30	09-09-29	18-09-30
YC90751	SUZI	31	09-09-29	18-09-30
YC90752	SUZI	32	09-09-29	18-09-30
YC90753	SUZI	33	09-09-29	18-09-30
YC90754	SUZI	34	09-09-29	18-09-30
YC90755	SUZI	35	09-09-29	18-09-30
YC90756	SUZI	36	09-09-29	18-09-30
YC90757	SUZI	37	09-09-29	18-09-30

YC90758	SUZI	38	09-09-29	18-09-30
YC90759	SUZI	39	09-09-29	18-09-30
YC90760	SUZI	40	09-09-29	18-09-30
YC90761	SUZI	41	09-09-29	18-09-30
YC90762	SUZI	42	09-09-29	18-09-30
YC90763	SUZI	43	09-09-29	18-09-30
YC90764	SUZI	44	09-09-29	18-09-30
YC90765	SUZI	45	09-09-29	18-09-30
YC90766	SUZI	46	09-09-29	18-09-30
YC90767	SUZI	47	09-09-29	18-09-30
YC90768	SUZI	48	09-09-29	18-09-30
YC90769	SUZI	49	09-09-29	18-09-30
YC90770	SUZI	50	09-09-29	18-09-30
YC90771	SUZI	51	09-09-29	18-09-30
YC90772	SUZI	52	09-09-29	18-09-30
YC90773	SUZI	53	09-09-29	18-09-30
YC90774	SUZI	54	09-09-29	18-09-30
YC90775	SUZI	55	09-09-29	18-09-30
YC90776	SUZI	56	09-09-29	18-09-30
YC90777	SUZI	57	09-09-29	18-09-30
YC90778	SUZI	58	09-09-29	18-09-30
YC90779	SUZI	59	09-09-29	18-09-30
YC90780	SUZI	60	09-09-29	18-09-30
YC90781	SUZI	61	09-09-29	18-09-30
YC90782	SUZI	62	09-09-29	18-09-30
YC90783	SUZI	63	09-09-29	18-09-30
YC90784	SUZI	64	09-09-29	18-09-30
YC90785	SUZI	65	09-09-29	18-09-30
YC90786	SUZI	66	09-09-29	18-09-30
YC90787	SUZI	67	09-09-29	18-09-30
YC90788	SUZI	68	09-09-29	18-09-30
YC90789	SUZI	69	09-09-29	18-09-30
YC90790	SUZI	70	09-09-29	18-09-30
YC90791	SUZI	71	09-09-29	18-09-30
YC90792	SUZI	72	09-09-29	18-09-30
YC90793	SUZI	73	09-09-29	18-09-30
YC90794	SUZI	74	09-09-29	18-09-30
YF40429	SUZI	75	12-08-05	18-09-30
YF40430	SUZI	76	12-08-05	18-09-30
YF40431	SUZI	77	12-08-05	18-09-30
YF40432	SUZI	78	12-08-05	18-09-30
YF40433	SUZI	79	12-08-05	18-09-30

YF40434	SUZI	80	12-08-05	18-09-30
YF40435	SUZI	81	12-08-05	18-09-30
YF40436	SUZI	82	12-08-05	18-09-30
YF40437	SUZI	83	12-08-05	18-09-30
YF40438	SUZI	84	12-08-05	18-09-30
YF40439	SUZI	85	12-08-05	18-09-30
YF40440	SUZI	86	12-08-05	18-09-30
YF40441	SUZI	87	12-08-05	18-09-30
YF40442	SUZI	88	12-08-05	14-08-06
YF40443	SUZI	89	12-08-05	18-09-30
YF40444	SUZI	90	12-08-05	18-09-30
YF40445	SUZI	91	12-08-05	18-09-30
YF40446	SUZI	92	12-08-05	14-08-06
YF40447	SUZI	93	12-08-05	14-08-06
YF40448	SUZI	94	12-08-05	14-08-06
YF40449	SUZI	95	12-08-05	14-08-06
YF40450	SUZI	96	12-08-05	14-08-06
YF40451	SUZI	97	12-08-05	14-08-06
YF40452	SUZI	98	12-08-05	14-08-06
YF40453	SUZI	99	12-08-05	14-08-06
YF40454	SUZI	100	12-08-05	14-08-06
YF40455	SUZI	101	12-08-05	14-08-06
YF40456	SUZI	102	12-08-05	14-08-06
YF40457	SUZI	103	12-08-05	14-08-06
YF40458	SUZI	104	12-08-05	14-08-06
YF40459	SUZI	105	12-08-05	14-08-06
YF40460	SUZI	106	12-08-05	14-08-06
YF40461	SUZI	107	12-08-05	14-08-06
YF40462	SUZI	108	12-08-05	14-08-06
YF40463	SUZI	109	12-08-05	14-08-06
YF40464	SUZI	110	12-08-05	14-08-06
YF40465	SUZI	111	12-08-05	14-08-06
YF40466	SUZI	112	12-08-05	14-08-06
YF40467	SUZI	113	12-08-05	14-08-06
YF40468	SUZI	114	12-08-05	14-08-06
YF40469	SUZI	115	12-08-05	14-08-06
YF40470	SUZI	116	12-08-05	14-08-06
YF40471	SUZI	117	12-08-05	14-08-06
YF40472	SUZI	118	12-08-05	14-08-06
YF40473	SUZI	119	12-08-05	14-08-06
YF40474	SUZI	120	12-08-05	14-08-06
YF40475	SUZI	121	12-08-05	14-08-06

YF40476	SUZI	122	12-08-05	14-08-06
YF40477	SUZI	123	12-08-05	14-08-06
YF40478	SUZI	124	12-08-05	14-08-06
YF40479	SUZI	125	12-08-05	14-08-06
YF40480	SUZI	126	12-08-05	14-08-06
YF40481	SUZI	127	12-08-05	14-08-06

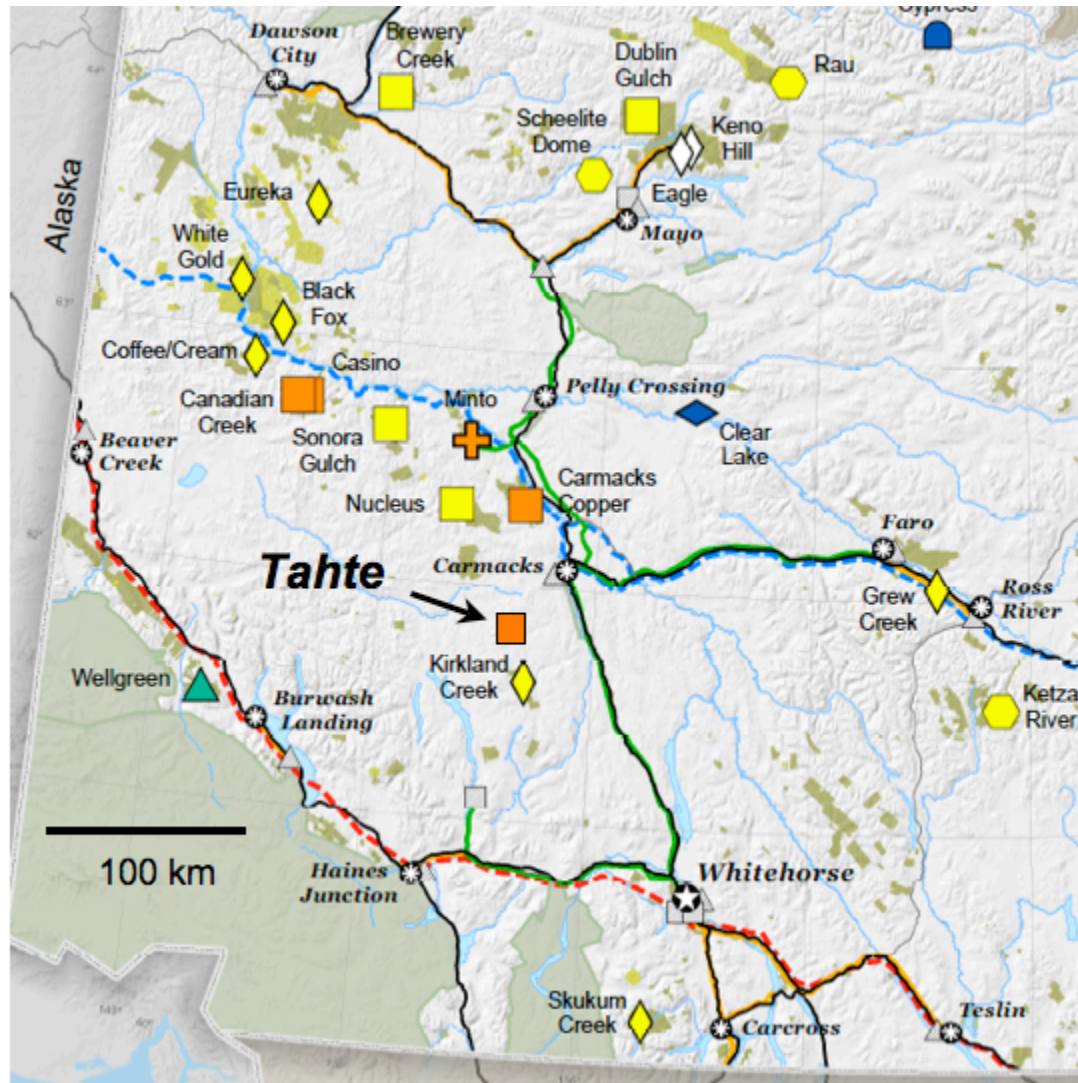

Figure 1. Location map of the Tahte property in relation to towns, infrastructure and other nearby projects in southwest Yukon.

# Mineral Claims and Land Status

(January 2014)

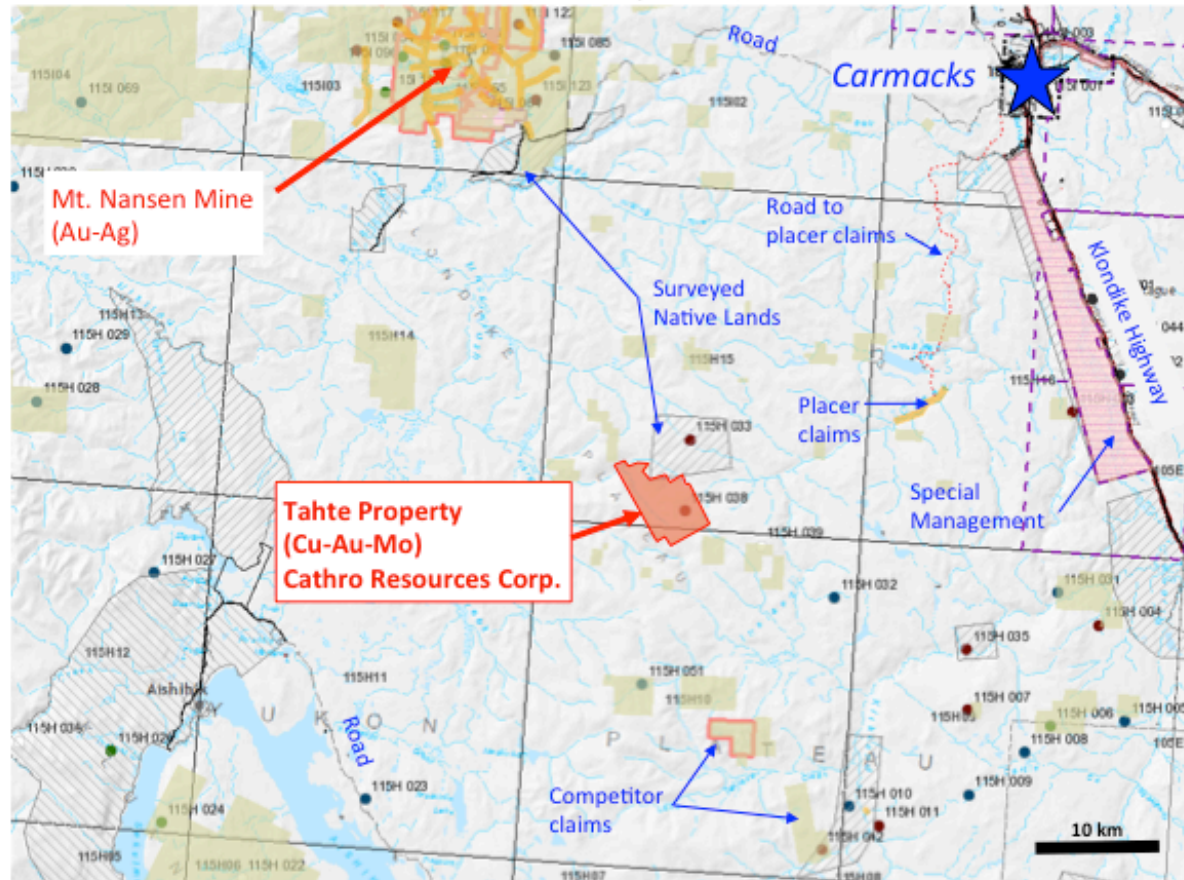

Figure 2. Claim map of Tahte Property also showing roads, land status, MINFILE occurrences and towns.

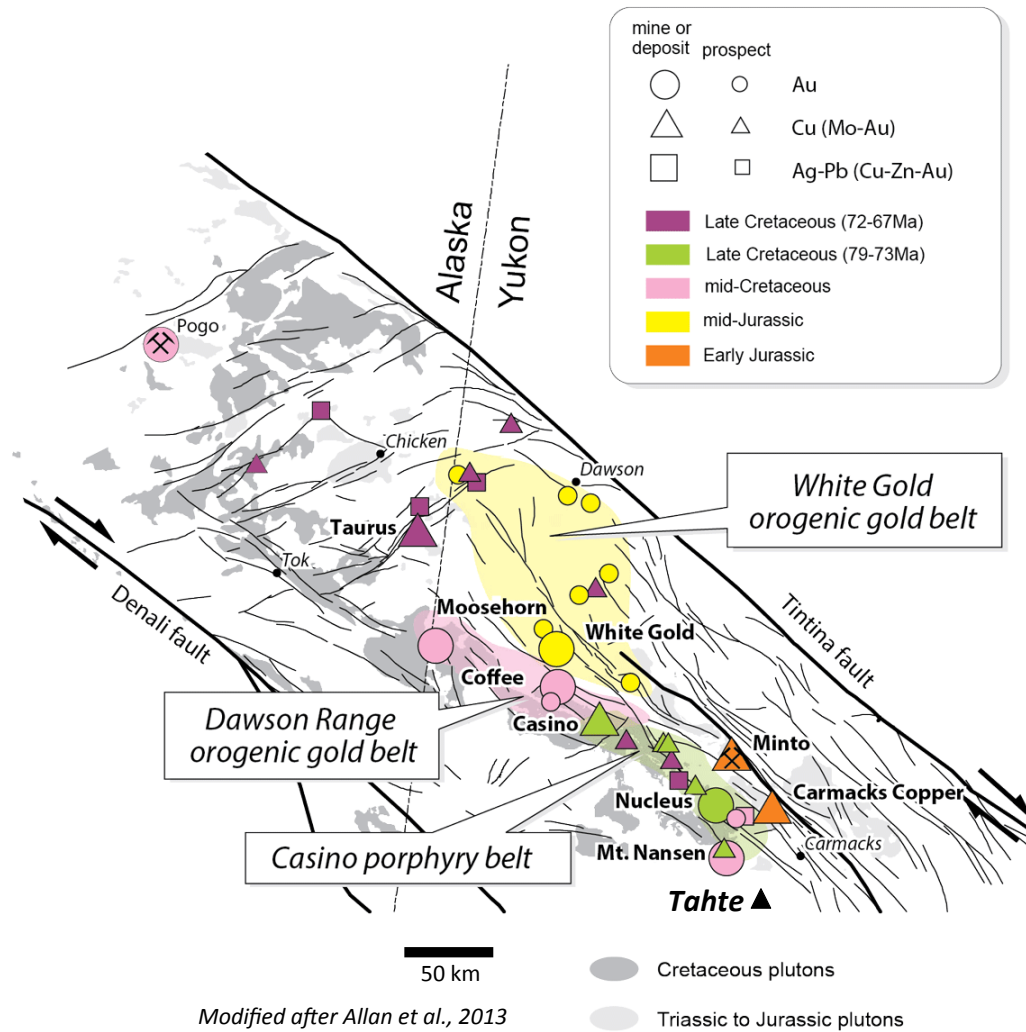

Figure 3. Location of Tahte property in relation to other key deposits and metallogenic belts.

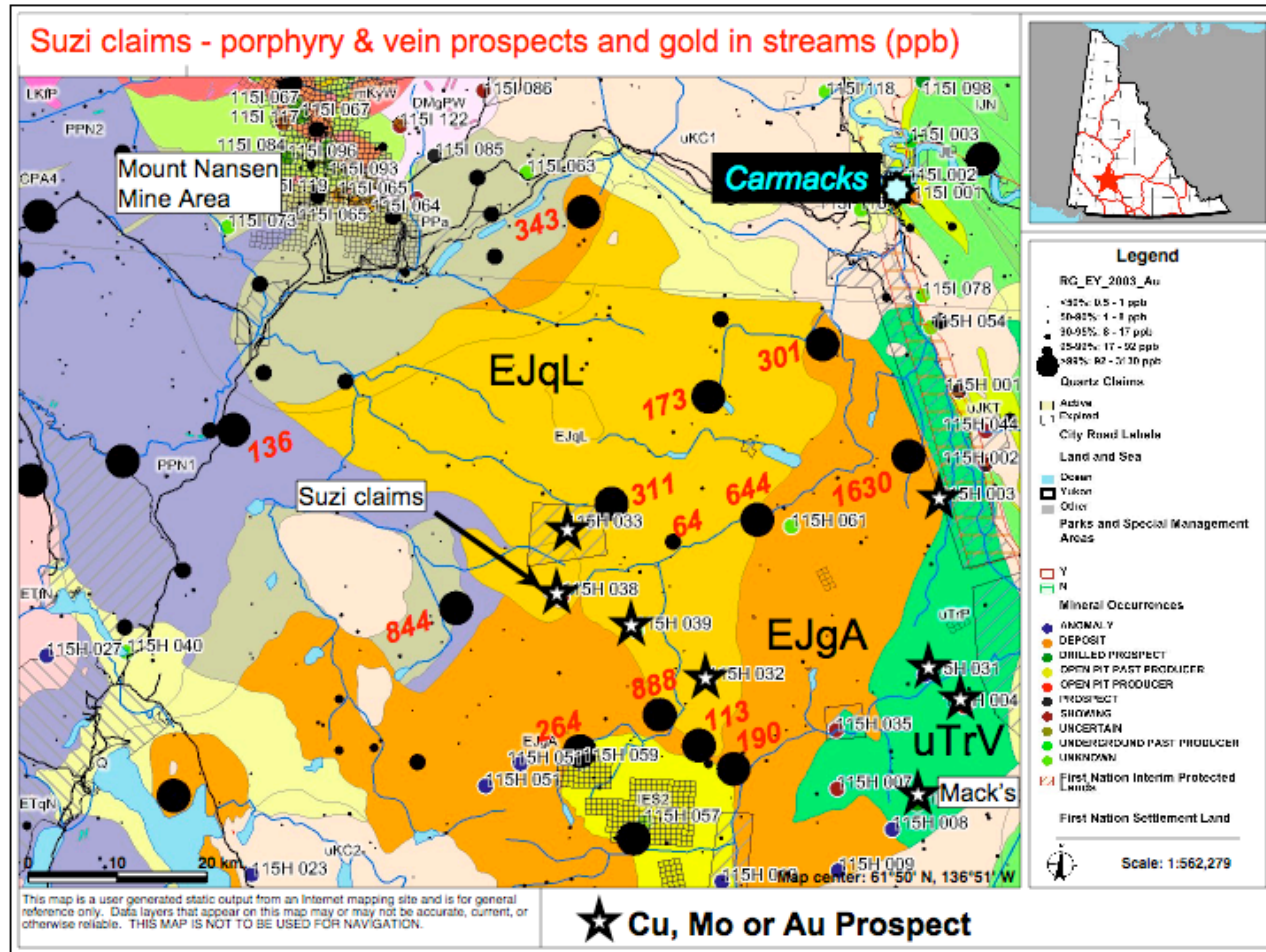

Figure 4. Regional Geology of the Tahte property showing key prospects and gold (ppb) in RGS values (from Yukon MapMaker website).

# Tahte Regional Data

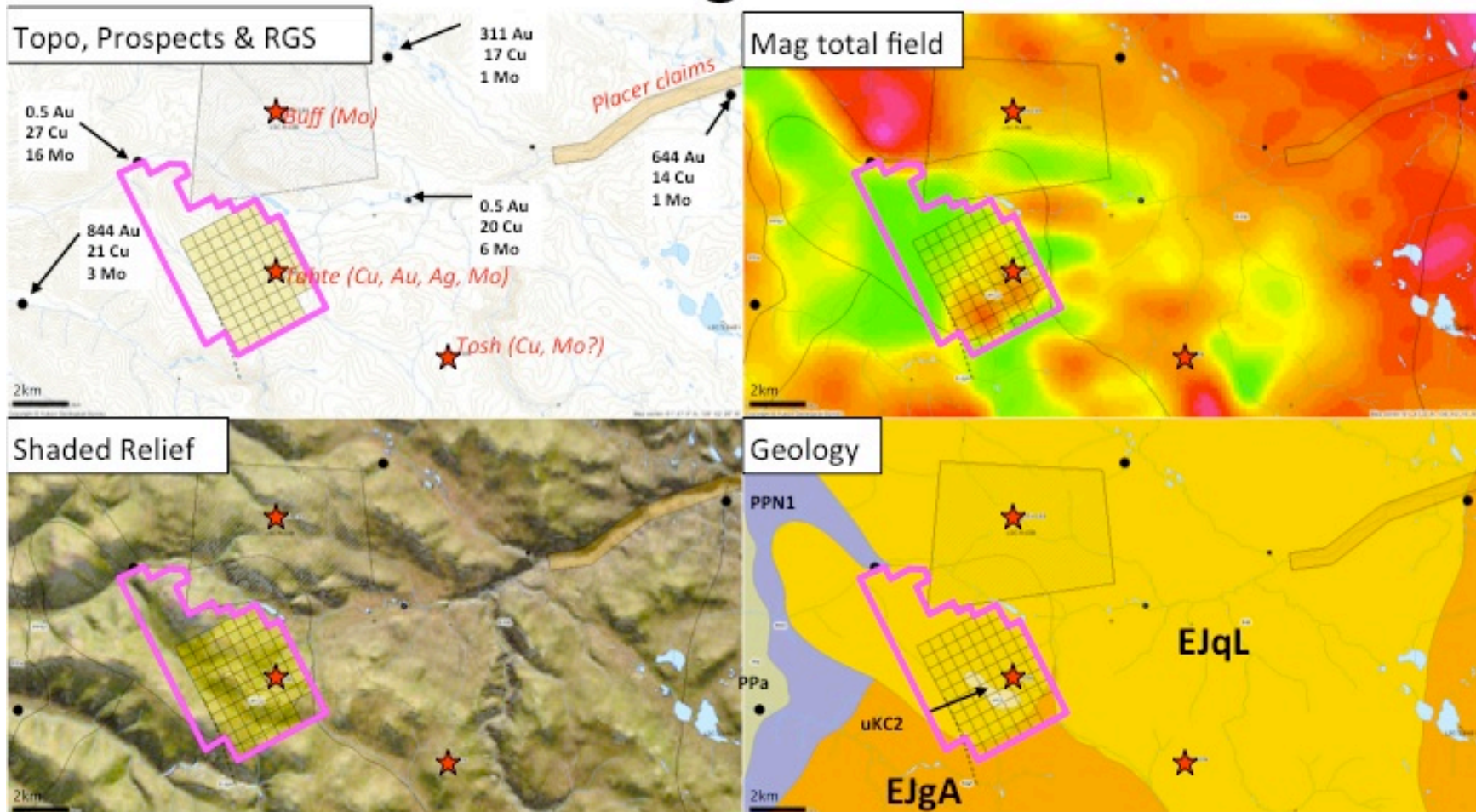

Figure 5. Maps of Tahte property showing MINFILE prospects and stream sediments (RGS for Au, Cu, Mo) on background images of topography, airborne magnetic total field, shaded relief, and geology (from Yukon MapMaker Website).

The Noranda IP survey showed a range of Percent Frequency Effect (PFE) values from 0% to 20.75% and a background of 1.5 to 2.0%. A large number of readings could not be taken because of poor ground conditions (Fairbank et al., 1977). A distinct PFE “ridge” (10 to 20.75% PFE, or 5-10 times background) extends for about 1500 m in a NW-SE direction (note that PFE is a measure of the IP effect and is the frequency domain equivalent of “chargeability” in a time domain IP survey). A distinct resistivity low (less than 100 ohm-feet) is partly coincident with the PFE high ridge. The relative magnetic vertical field survey showed a range of about 2580 gammas over the survey area. Highs appear to align with mapped areas of feldspar porphyry (interpreted here to be Carmacks Group volcanics).

Fairbank et al. (1977) concluded that the IP and geology surveys indicated the potential for a porphyry-type Cu-Mo occurrence associated with the feldspar porphyry unit. It should be noted that Noranda provided no surface rock or soil sampling results in either the 1977 or 1980 reports, however, the authors recommended *additional* soil sampling (my italics), detailed mapping and alteration studies prior to drilling. It is possible some surface samples were collected but results were not submitted.

In 1980, Noranda completed three short diamond drill holes totaling 269 m on the Tah claims (Macdonald, 1980), however, the report does not explain what features or anomalies were being tested. The drill hole location map in the report is very rudimentary and the grid coordinates of two of the holes show them being at the same location, which does not match with the map. The collars of two drill holes (assumed to be TA-80-01 and 03) were located during the 2010 field program and are shown on Figure 7 and 9.

Based on the original Noranda grid coordinates, the drill holes appear to have tested an area of moderate PFE values, approximately midway between the PFE “ridge” and the mapped kaolinite-sericite-silica alteration zones. The holes encountered the three intrusive phases described above plus a dark green dyke rock. The logs describe moderate to intense alteration (clay, sericite, hematite, jarosite), intense fracturing and weathering, quartz veining, up to 5-10% disseminated pyrite in multiple intrusive phases, along with occasional malachite, molybdenite, fluorite and gypsum. Assaying was incomplete, however, several weakly mineralized sections were reported (here converted to metric):

Hole	Length (m)	Grade
#1	19.8	0.12 g/t Au
and	19.8	0.07 % Cu (deeper in hole)
#3	20.3	0.144 g/t Au and 10.53 g/t Ag
incl	1.54	0.96 g/t Au
and	4.56	16.2 g/t Ag

The core is stored in the YGS Bostock core library in Whitehorse and was re-logged and assayed in 2010 as described below (Cathro and Pautler, 2011).

One rock sample and three heavy mineral samples were collected by Golden Quail Resources Ltd. in 1989 on the “Nick III claim (Lambert, 1989). These samples were analyzed for Au, Pt and Pd. One heavy mineral sample, draining the western side of the Tahte project area, was reported to be anomalous for Au (139 ppb).

In June 2010, the current owner completed a small program of silt and soil sampling and prospecting. In addition, re-logging and sampling of historic Noranda drill core was completed at the Bostock Core Library in Whitehorse by Jean Pautler, P.Geol and Robert Stroshein, P.Eng between August 28 and September 12, 2010 (Cathro and Pautler, 2011). The work confirmed that Cu-Mo-Au mineralization is associated with silica, clay and sericite-pyrite alteration of a multiphase intrusive complex. Although assays are not ore-grade, Holes TA-80-01 and 03 (also known as “TAH-80-01 etc. in reports) encountered weak to moderate porphyry-style alteration and mineralization over their full lengths with maximum values reaching 170 ppb Au, 1134 ppm Cu and 229 ppm Mo. The best results were from TA-80-03, which returned 50.82 m grading 113 ppb Au, 735 ppm Cu and 91 ppm Mo from 11.28 to 62.1 m, plus 15.15 m grading 82 ppb Au, 493 ppm Cu and 137 ppm Mo from 69.85 to 85 m (end of hole). The alteration, host rocks, mineralogy and metal values are consistent with weak porphyry-style mineralization. Au, Cu and Mo assays for the 2010 re-sampling are presented in Table 2.

Based on a review of the historic Noranda maps and data, the three drill holes appear to have been drilled 60 m apart on a single fence on the flank of a 1500 metre-long chargeability high (5-10 times background). Given the alteration and pyrite content of the drill core, it can be inferred that the holes intersected the marginal “pyrite halo” of a porphyry deposit based on a classic zonation model for this type of deposit.

A new zone of porphyry-style molybdenum mineralization was discovered in bedrock and subcrop approximately 1 km to the NW of the historic drilling. The “Ribbon showing” hosts quartz-molybdenite veins are up to 5 m wide, and assays from grab samples returned up to 1835 ppm Mo (or 0.306% MoS<sub>2</sub>).

Of additional importance, a broad area (>500 m by 1000 m) of pervasive silica-clay-sericite-pyrite alteration of intrusive rock was identified in the area of the historic holes. Unfortunately, surface sampling results were disappointing. More work needs to be done to determine why the holes contain anomalous values of Cu, Mo and Au but surface grabs in the same area are barren.

24 silt samples collected in 2010 show relatively subdued responses for Cu, Au and Cu, although weak but detectable anomalies were identified in the area of the historic drilling (10 ppb Au, 64 ppm Cu, and 4-5 ppm Mo). Moss mats taken directly north of and down hill from the drill holes returned <5 – 15 ppb Au, 20-40 ppm Cu and 2-8 ppm Mo.

Soil sampling was severely hampered by frozen soil and loess, and consequently, most of the 155 samples were only collected at a depth of 10 to 30 cm. Nevertheless, in the area of the historic drilling, the soils show some weakly anomalous values for Au (30-50 ppb), Cu (60-138 ppm) and Mo (spot highs to 41 ppm).

Additional prospecting and soil sampling was completed in 2012 (Cathro, 2013). Subcropping quartz-molybdenite mineralization in the Ribbon zone was traced to the northwest onto the newly staked Suzi 84 claim. The strike length of the Ribbon zone is now known to be at least 1500 m and it is still open to the NW and SE. Seven of 20 samples collected in 2012 returned values exceeding 500 ppm Mo (or 0.08% MoS<sub>2</sub>), with the highest being 4340 ppm Mo (or 0.72% MoS<sub>2</sub>). Individual quartz-molybdenite veins are up to 5-7 m wide and appear to be subvertical and generally striking about 300 degrees. Mineralization consists of fine-grained molybdenite (locally to 3-5% of rock), trace to strong staining of ferrimolybdenite and limonite, and weakly disseminated medium-grained euhedral pyrite. The veins are hosted in a coarse-grained, weakly altered quartz monzonite.

The 2012 soil sampling comprised 29 B-horizon samples on 3 lines across a broad ridge and was successful in outlining the Ribbon zone with values ranging up to 39.7 ppm Mo. A discrete soil anomaly (> 3 ppm Mo) is coincident with the subcropping quartz-moly mineralization, and is open to the N, E and S.

Also, in 2012, 40 deep soil samples were collected on two test lines across the Tahte zone in the area of the 1980 Noranda drill holes. The samples were collected with a power-auger at depths of 85 cm with the goal to collect samples beneath the frozen loess in the broad, north-facing valley, where sampling was hampered in 2010. The 2012 power-auger samples were described as brown silt and sand and appear to be dominated by loess. Metal values were not substantially different than the shallow soils (10-30 cm depth) collected in 2010. Additional investigations may be necessary to determine whether much deeper soil sampling would be more effective (e.g. 2-3 m depth).

Table 2.  
2010 Drill Core Assays of Re-sampled 1980 Noranda Drill Holes TA-80-01 to 03 (from Pautler and Cathro, 2011). (Note, the holes are also prefixed TAH on some reports)

**Hole TA-80-01**

Sample #	From	To	Int (m)	Au ppb FA	Cu ppm	Mo ppm
29051	26.52	29.55	3.03	60	466	24
29052	29.55	32.55	3.00	60	282	20
29053	32.60	35.66	3.06	70	320	35
29054	35.66	37.19	1.53	90	376	38
29055	37.19	38.71	1.52	50	424	17
29056	38.71	40.15	1.44	40	316	24
29057	40.15	43.28	3.13	50	504	34
29058	43.28	44.80	1.52	35	658	35
29059	44.80	47.00	2.20	65	922	33
29060	47.00	49.38	2.38	60	628	20
29061	49.38	50.75	1.37	60	768	24
29062	50.75	52.70	1.95	55	850	43
29063	52.70	55.17	2.47	80	636	41
29064	55.17	58.20	3.03	65	656	39
29065	58.20	61.56	3.36	40	548	59
29066	61.56	64.62	3.06	65	370	63
29067	64.62	67.67	3.05	115	648	116
29068	67.67	70.71	3.04	65	790	142
29071	70.71	73.76	3.05	80	608	39
29072	73.76	76.81	3.05	80	392	42
29073	76.81	78.33	1.52	35	454	32
29074	78.33	81.38	3.05	50	356	31
29075	81.38	83.30	1.92	80	554	55
29076	83.30	86.40	3.10	30	766	45
29077	86.40	89.00	2.60	25	718	66
29078	89.00	92.05	3.05	40	400	14

**Hole TA-80-02**

Sample #	From	To	Int (m)	Au ppb FA	Cu ppm	Mo ppm
29079	10.67	12.80	2.13	15	134	14
29080	12.80	15.85	3.05	15	82	16
29081	15.85	18.90	3.05	10	158	7
29082	18.90	20.42	1.52	5	126	1
29083	20.42	23.00	2.58	45	112	2
29084	23.00	25.30	2.30	15	322	6
29085	25.30	28.04	2.74	10	160	2
29086	28.04	31.20	3.16	15	84	3
29087	31.20	34.10	2.90	25	190	45
29088	34.10	35.20	1.10	15	108	9

29089	35.20	38.71	3.51	20	154	7
29090	38.71	40.20	1.49	25	242	15
No samples 40.2 to 47.27 m - Box 4 missing (7.07 m core)						
29093	47.27	49.38	2.11	45	394	20
29094	49.38	51.90	2.52	20	122	6
29095	51.90	52.43	0.53	5	30	2
29096	52.43	55.47	3.04	10	124	3
29097	55.47	58.52	3.05	5	40	8
29098	58.52	60.00	1.48	10	198	9
29099	60.00	63.09	3.09	10	146	10
29100	63.09	66.50	3.41	15	158	17
15408	66.50	68.00	1.50	25	196	4
15409	68.00	70.70	2.70	25	300	10
15410	70.70	72.55	1.85	25	274	6
15411	72.55	74.20	1.65	15	150	26
15412	74.20	75.25	1.05	10	102	3
15413	75.25	78.33	3.08	25	290	10
15414	78.33	79.86	1.53	10	152	6
15415	79.86	81.38	1.52	10	108	4
15416	81.38	84.43	3.05	20	236	3
15417	84.43	87.48	3.05	30	182	15
15418	87.48	90.55	3.07	15	214	605
15419	90.55	93.57	3.02	15	208	28

**Hole TA-80-03**

Sample #	From	To	Int (m)	Au ppb FA	Cu ppm	Mo ppm
15422	11.28	12.80	1.52	115	502	66
15423	12.80	15.85	3.05	65	532	57
15424	15.85	17.70	1.85	55	444	69
15425	17.70	20.00	2.30	60	472	55
15426	20.00	23.70	3.70	100	846	133
15427	23.70	26.52	2.82	170	1134	110
15428	26.52	29.57	3.05	150	788	101
15429	29.57	31.09	1.52	160	792	92
15430	31.09	32.60	1.51	170	856	203
15431	32.60	35.35	2.75	150	1024	117
15432	35.35	37.19	1.84	115	722	77
15433	37.19	40.23	3.04	130	812	138
15434	40.23	42.98	2.75	130	694	99
15435	42.98	44.81	1.83	135	780	106
15436	44.81	47.70	2.89	90	536	60
15437	47.70	50.40	2.70	120	482	47
15438	50.40	53.40	3.00	80	530	46
15441	53.40	55.47	2.07	75	694	118
15442	55.47	58.52	3.05	95	1014	72
15443	58.52	62.10	3.58	120	816	86

no samples 62.1 to 69.85 m - Box 8 missing (7.75 m core)						
15444	69.85	70.71	0.86	65	444	229
15446	70.71	73.76	3.05	35	332	60
15447	73.76	76.81	3.05	115	590	122
15448	76.81	79.00	2.19	75	468	127
15449	79.00	79.90	0.90	35	156	25
15450	79.90	82.91	3.01	90	566	202
15451	82.91	85.00	2.09	125	672	195

## 8.0 2013 WORK PROGRAM

### Methodology

The 2013 field program was completed between July 12 and 22. The field crew comprised 6 people and was based at a fly-camp near the historic Noranda camp at the Tahte zone. The equipment and crew were transported to the site by Trans North 206B helicopter from a staging point on the Klondike Highway. Access on the claims was by foot.

### Soil sampling and prospecting

A total of 73 B-horizon soil samples and 3 rock samples were collected in the vicinity of the Ribbon moly zone and Tahte zone (Figure 6). The soil samples were primarily collected on open ridges where permafrost and loess are minimal. Locations were recorded on a handheld GPS and sample descriptions were made in a field book. Soil samples were collected primarily from the B-horizon at a depth of 15 to 40 cm using a small pick. Samples were placed along with individually numbered sample tags in sealed poly bags (rocks) or kraft envelopes (soils) for shipment to the lab.

Samples were delivered to the Whitehorse preparation facility of ALS Minerals. Pulps were prepared for later shipment and analysis at the ALS Minerals laboratory in North Vancouver, BC.

Rocks were crushed, pulverized (ALS Prep-31 method) and analyzed by a 30 g fire assay with ICP finish for gold (ALS Au-ICP21 method) and an ultra-trace ICP analysis for 51 elements following aqua regia digestion (ALS ME-MS41 method).

Soils were dried and sieved to -180um. A 25 g split was digested in aqua regia and analyzed by Au and 51 other elements by ICP (ALS methods TL43 and ME-MS41).

Merged tables of sample locations, descriptions and analytical results for key elements are included in Appendix 1. Analytical certificates are included in Appendix 2. In addition, a disk is included which includes the same sample information in excel format.

### IP Geophysics

Three parallel Induced Polarization (IP) survey lines were laid out in an ENE direction to cross known geophysical and geological features (Figure 6). From south to north, the IP

lines were 3300 m, 3300 m and 2500 m in length. Line 700N, the southernmost line, was designed to cross a broad covered valley with a strong “Percent Frequency Effect” (chargeability) feature identified by Noranda in 1977. This line also transects the collars of two short, historic Noranda drill holes (TA-01 and 03) with strongly anomalous Au, Cu and Mo values, along with weakly anomalous Au, Cu and Mo values in soils. Line 1200N was 500 m to the north of Line 700N and was designed to cross the NW portion of the Noranda chargeability feature and partially coincident soil anomalies. Line 2700N, 1500 m further north, was designed to cross the subcropping Ribbon moly zone and a strong open-ended moly in soil anomaly on a broad ridge. The following text is taken from the report by Walcott (2014), which is included as Appendix 3 of this report.

The induced polarization (IP) survey was conducted using a pulse type system, the principal components of which were manufactured by Instrumentation GDD of St. Foy, Quebec.

The system consists basically of three units, a receiver (GDD), transmitter (GDD) and a motor generator. The transmitter, which provides a maximum of 5 kw d.c. to the ground, obtains its power from a 9 kw 60 c.p.s. single phase alternator driven by a Honda 14 h.p. gasoline engine. The cycling rate of the transmitter is 2 seconds “current-on” and 2 seconds “current-off” with the pulses reversing continuously in polarity. The data recorded in the field consists of careful measurements of the current (I) in amperes flowing through the current electrodes C1 and C2, the primary voltages (V) appearing between any two sequential potential electrodes, P1 through P<sub>n+1</sub>, during the “current-on” part of the cycle, and the apparent chargeability, (Ma) presented as a direct readout in millivolts per volt using a 200 millisecond delay and a 1000 millisecond sample window by the receiver, a digital receiver controlled by a micro-processor – the sample window is actually the total of twenty individual windows of 50 millisecond widths.

The apparent resistivity ( $\rho_a$ ) in ohm metres is proportional to the ratio of the primary voltage and the measured current, the proportionality factor depending on the geometry of the array used. The chargeability and resistivity are called apparent as they are values which that portion of the earth sampled would have if it were homogeneous. As the earth sampled is usually inhomogeneous the calculated apparent chargeability and resistivity are functions of the actual chargeability and resistivity of the rocks.

The survey was carried out using the “pole-dipole” method of surveying. In this method the current electrode, C1, and the potential electrodes, P1 through P<sub>n+1</sub>, are moved in unison along the survey lines at a spacing of “a” (the dipole) apart, while the second current electrode, C2, is kept constant at “infinity”. The distance, “na” between C1 and the nearest potential electrode generally controls the depth to be explored by the particular separation, “n”, traverse.

On this survey 100 m dipoles were employed and first to six separation readings were obtained. In all some 9.1 kilometres of IP traversing were completed on three lines as shown on Figure 6.

### *Horizontal control.*

The horizontal position of the stations were recorded using an WAAS equipped Garmin C60 handheld GPS receiver.

### *Data Presentation.*

The IP data are presented as an individual pseudo-section plot of apparent chargeability and resistivity at a scale of 1:10,000 (Appendix 3). Plots of the 21 point moving filter – illustrated on the pseudo section – for the above are also displayed in the top window to better show the location of the anomalous zones.

Two dimensional smooth model inversion of the resistivity and chargeability was carried out using the Geotomo RES2DINV Algorithm, an algorithm developed by Loke et-al. This algorithm uses a 2-D finite element method and incorporates topography in modeling resistivity and I.P. data. Nearly uniform starting models are generated by running broad moving-average filters over the respective lines of data. Model resistivity and chargeability properties are then adjusted iteratively until the calculated data values match the observed as closely as possible, given constraints which keep the model section smooth. The smooth chargeability and resistivity models were then imported into Geosoft format for presentation at the same scale of 1:10,000 on the topographic profile. A slight discrepancy can be observed between the measured and modeled plots as the former are processed in Geosoft which assumes horizontal distances for the station separation. The inversions are included as Figures 10, 11, and 12.

## 9.0 RESULTS AND CONCLUSIONS

### Rock Sampling

The prospecting was successful in identifying anomalous moly values in two grab samples of subcropping quartz vein material (Figure 6). Sample T13R006 (287 ppm Mo) is located to the southwest of the Tahte and Ribbon zones and represents a discovery of new quartz-molybdenum mineralization of unknown significance. Sample T13R012 (409 ppm Mo) is located at the southeast end of the Ribbon moly zone.

### Soils

Soil sampling was also successful in further extending previously identified Au, Cu and Mo anomalies between the Ribbon and Tahte zones, and east of the Ribbon zone. Values in soil range up to 0.035 ppm Au (35 ppb Au), 87.4 ppm Cu and 51.6 ppm Mo. Results for all B-horizon samples collected between 2010 and 2013 are compiled on Figures 7 to 9 for Au, Cu and Mo respectively. The results further extend and infill the Au, Cu and Mo anomalies in the vicinity of the Ribbon and Tahte mineralized zones.

Overall, the metal values in B-horizon soils are quite subdued, which is expected given the deep cover of loess and permafrost on the primarily north facing slopes. Values are somewhat higher for Mo on the rocky ridge in the vicinity of the Ribbon zone, which was the primary focus of the 2013 sampling. Thresholds were chosen based on visual inspection of the tabular and mapped data, in relation to the location of subcropping

mineralization at the Ribbon Zone, and mineralized drill holes at the Tahte zone. Thresholds used for Figure 10-1 are as follows:

<b>Element</b>	<b>Possibly Anomalous</b>	<b>Probably Anomalous</b>	<b>Maximum</b>
Au (ppb)	10	20	50
Cu (ppm)	20	30	138
Mo (ppm)	3	6	184

As was noted in the 2012 report, additional test work is needed to identify the best approach for surficial geochemistry on north facing slopes with permafrost and loess. Techniques to try may include deep (2-3 m) sampling of the C-horizon soils by power auger, or selective extraction techniques on the A-horizon.

### IP Surveying

The following is modified and expanded from Walcott, 2014 (Appendix 3 to this report).

Line 700N shows two intense chargeability features (Figure 10). The western feature centered at 2700E is associated with a broad chargeability zone (cA) extending to depth, within a low to moderate intensity resistivity feature. This feature is also coincident with a magnetic high readily seen in the historic and GSC magnetic data (Figure 15), along with a copper and molybdenum soil geochemistry anomaly. Two shallow historic drill holes – TAH-01 and TAH-03 (also known as TA-80-01 etc.), were also drilled proximal to the anomaly at 2800E and 2975E respectively with both returning highly anomalous values in gold, copper and molybdenum. To the east of the aforementioned anomaly, a second similar intensity anomaly (cB) is also readily observed centered at 3100E. The anomaly is directly associated with a low resistivity zone and is proximal to a copper and gold soil geochemistry anomaly. (Author's note, weak Cu and Au anomalies occur mainly coincident and east of Anomaly cB. The two drill holes and a weak Mo anomaly occur primarily between Anomalies cA and cB.)

Line 1200N (Figure 11) shows broad intense chargeability anomaly (Anomaly cC) centered at 2950E. This anomaly appears to extend to depth, and is contained within low to moderate intensity resistivity features. A weak coincident copper, molybdenum, and gold anomaly flanks the eastern portion of the anomaly between 3000E and 3500E. Lines 700N and 1200N show excellent correlation with the historic IP conducted by Noranda in the late 1970's (Figure 13).

Anomalies cB and cC appear to be associated with a lower resistivity feature (Figures 10, 11, and 14). It demonstrates an arcuate shape with the nose proximal to anomaly cC. This feature potentially wraps around to trend southwards and may be part of/associated with the low resistivity feature observed on the western flank on Anomaly cA.

Line 2700N (Figure 12) shows a weak chargeability – Anomaly cD - feature at depth and centred at approximately 3300E, on the eastern flank of a sharp resistivity contact. This chargeability feature appears to be associated with a resistivity low. (Author's note: Interestingly, chargeability is low and resistivity is very high in the area of the Ribbon

moly zone, which subcrops on the ridge between 2600E and 2800E. A moderate to strong Mo in soil anomaly, with scattered weakly anomalous gold values, covers the Ribbon zone and extends for an additional 500 m to the northeast where it is open down-slope in an easterly direction. It is the eastern portion of this soil anomaly that is underlain by chargeability Anomaly cD.)

## 10.0 SUMMARY AND RECOMMENDATIONS

This report describes a program of IP surveying, soil sampling and limited prospecting completed in July 2013. Prospecting in 2013 (3 rock samples) was successful in locating two additional areas of quartz-molybdenite mineralization in the Ribbon zone and SW of the Tahte zone.

Soil sampling in 2013 (73 samples) extended the Mo in soil anomaly associated with the Ribbon moly zone to the E, and to the SE towards the Tahte zone. Additional test work is needed to identify the best approach for surficial geochemistry on north facing slopes with permafrost and thick loess. Techniques to try may include deep (2-3 m) sampling of the C-horizon soils by power auger, or selective extraction techniques on the A-horizon.

With respect to the Ribbon moly zone, compilation of prospecting and soil sampling results from 2010, 2012 and 2013 now shows that this zone has a strike length of 2200 m in a NW-SE direction, and a width of 500 to 700 m. Mo is the primary element of interest, however, soils also indicate that there are scattered Au values in places. The Ribbon moly zone may merge with the Tahte zone to the NE, and is it still open to the NW and E. The best assay to date is 4340 ppm Mo (or 0.72% MoS<sub>2</sub>). Additional prospecting and soil sampling is warranted along this trend.

The 2013 induced polarization survey comprised 9.1 km of surveying on three lines and identified several features of potential interest:

Chargeability anomaly cA is located in the Tahte zone area, and is associated with a moderate intensity resistivity feature at depth.

Chargeability anomalies cB and cC appear to be associated with lower resistivity, and given the elevated Cu and Au in soil geochemistry, may also be a viable target.

It can now be seen that the shallow Noranda drill holes TAH-01 and TAH-03, which intersected anomalous Au, Cu and Mo over their full lengths, may not have effectively tested the Tahte target. These holes appear to have been drilled in a relative chargeability low between the strong anomalies cA and cB. In addition, the best soil geochemistry occurs to the NE of hole TAH-03 in association with chargeability anomaly cB. Further evaluations of the anomalies in this area should be undertaken.

Chargeability anomaly cD is a weak, deeper chargeability feature, with associated strong Mo and weak Au in soil anomalies, Anomaly cD is also proximal to the subcropping

Ribbon moly zone to the west, which is potentially associated with the intense resistivity high on the western end of this line.

The historic ground magnetic data shows a somewhat more complex pattern than observed in the GSC airborne survey. Additional ground mag should be undertaken over the entire area of interest. This data should then be compiled, and reviewed with the existing data. This would help guide in the planning of additional induced polarization surveying.

3D IP techniques should also be considered in the area surrounding anomaly cA-cC.

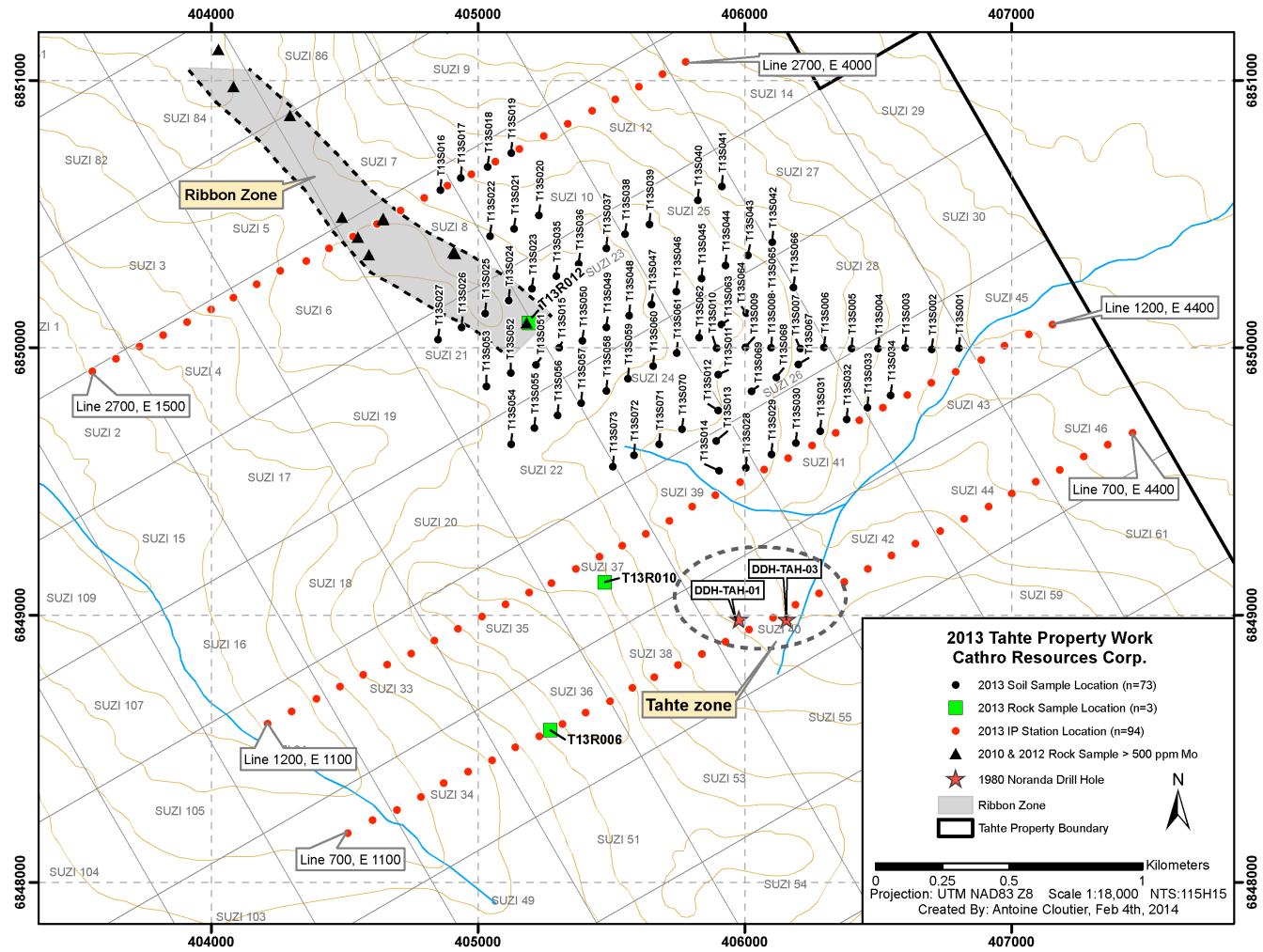

Figure 6. Location of 2013 IP lines and rock and soil samples, in relation to claim boundaries and known mineral zones.

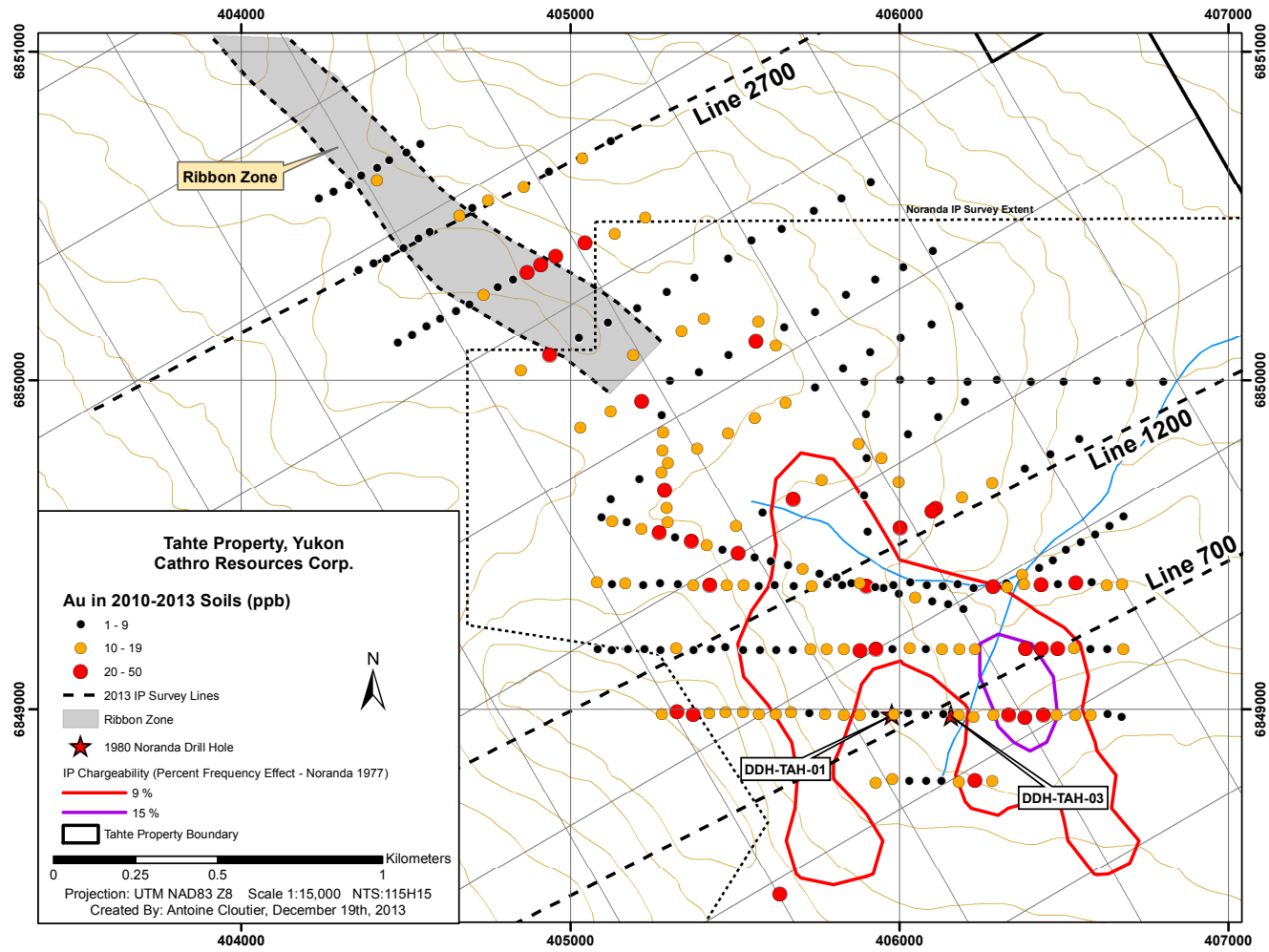

Figure 7. Map of Au in B-Horizon soil (2010 to 2013 samples).

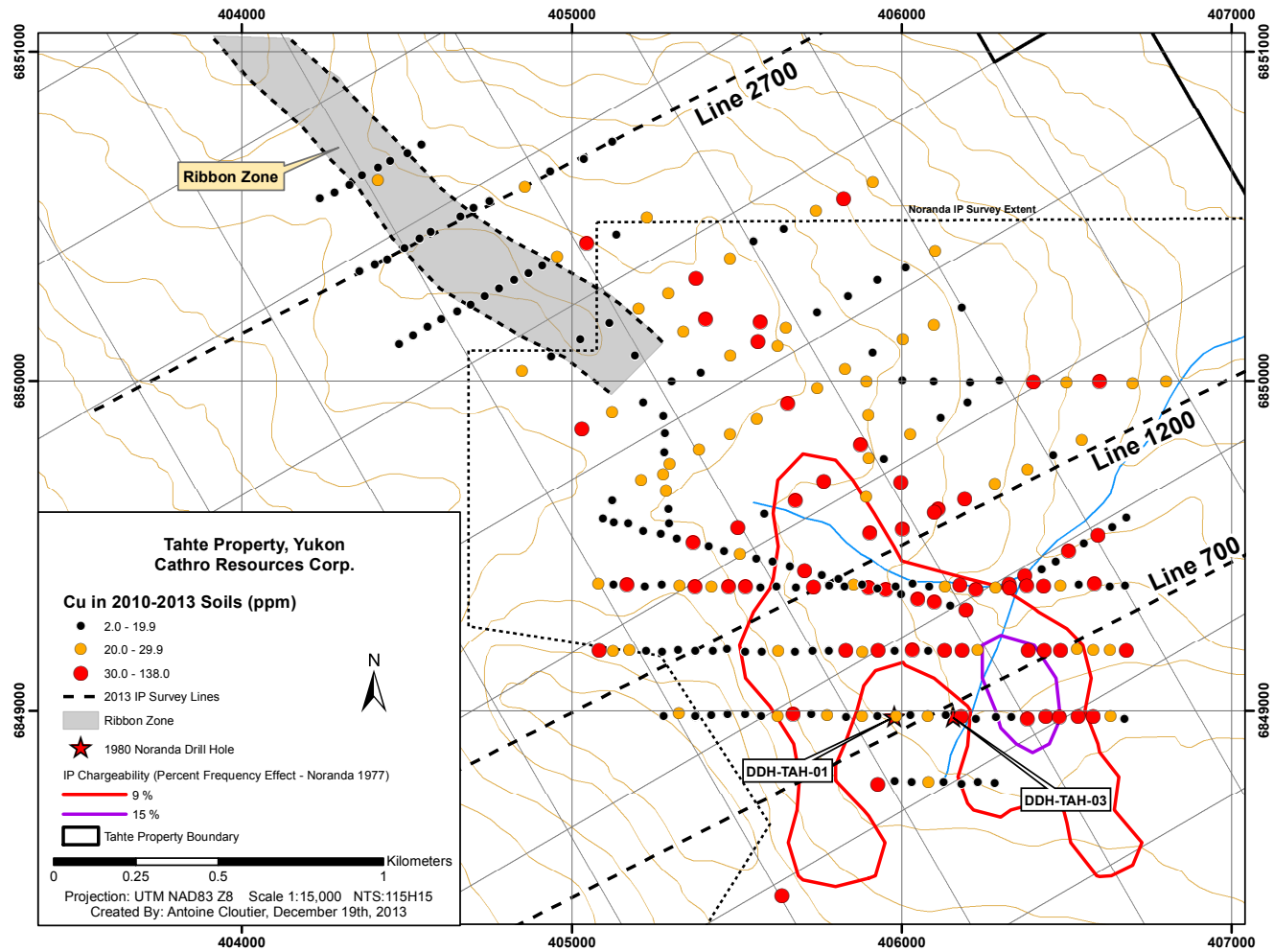

Figure 8. Map of Cu in B-horizon soil (2010 to 2013 samples).

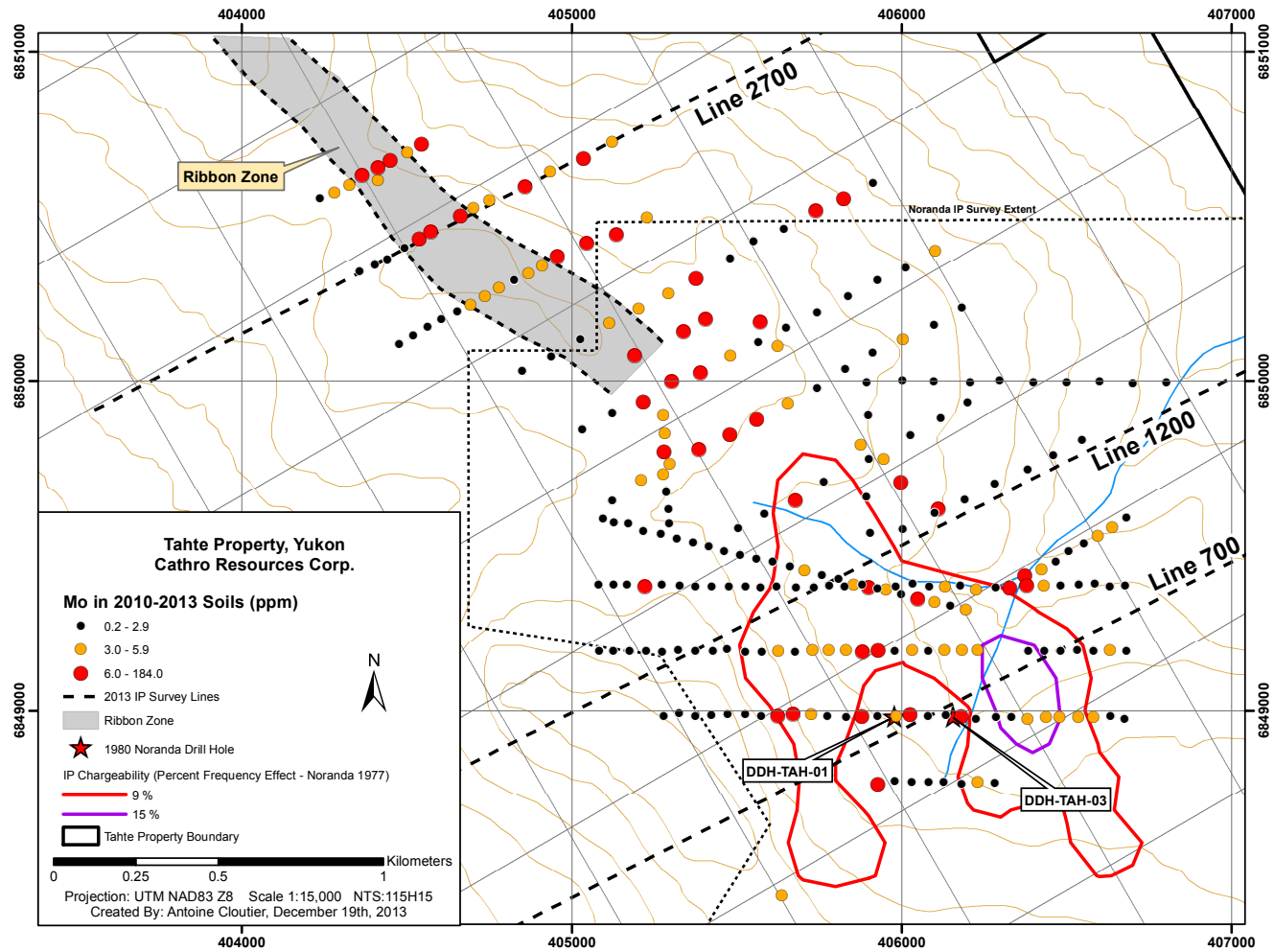

Figure 9. Map of Mo in B-horizon soil (2010 to 2013 samples).

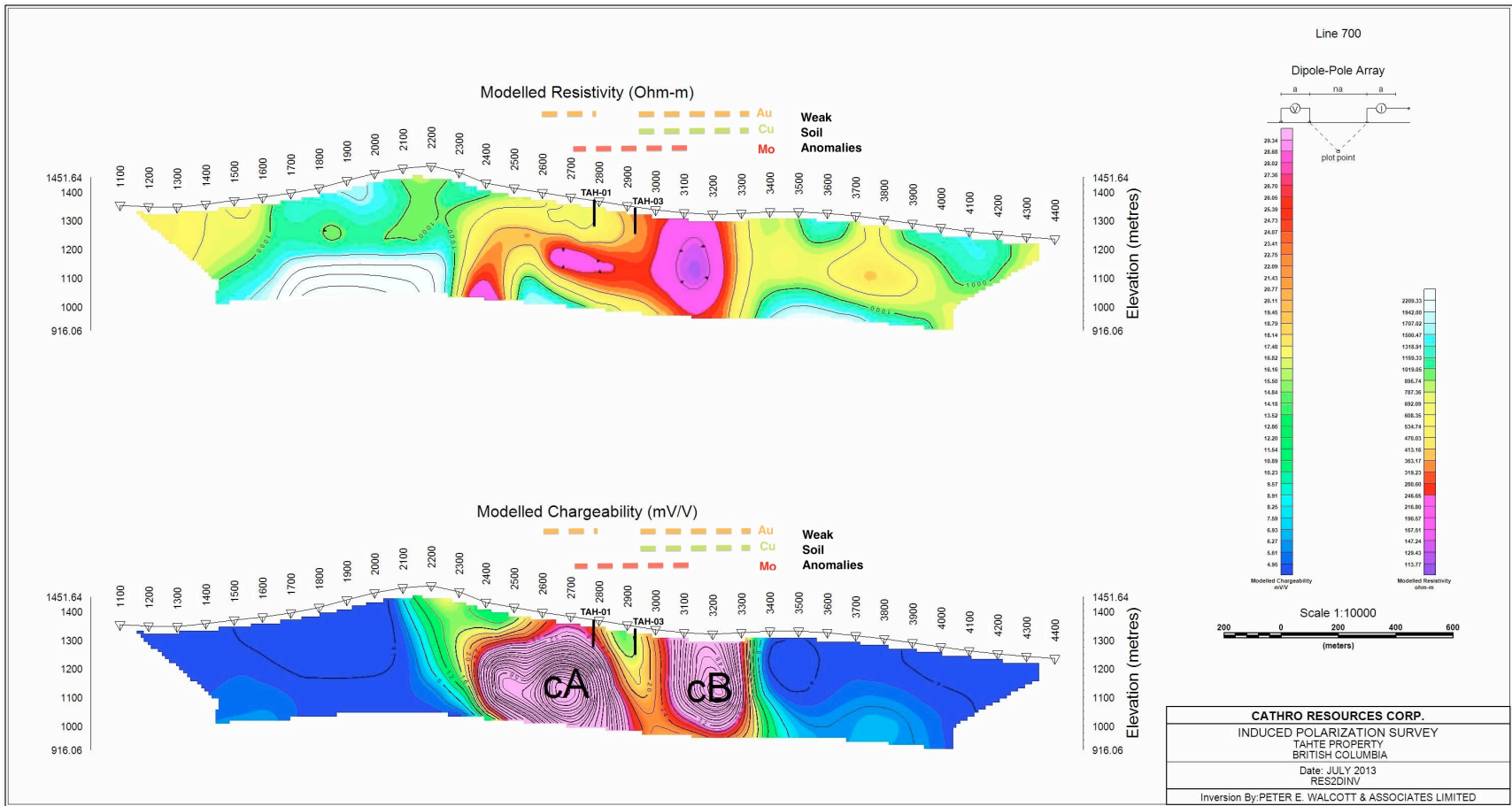

Figure 10. IP Inversions for Line 700N, including soil geochemical anomalies and projections of 1980 Noranda drill holes TAH-01 and TAH-03 (modified after Walcott, 2014, Appendix 3).

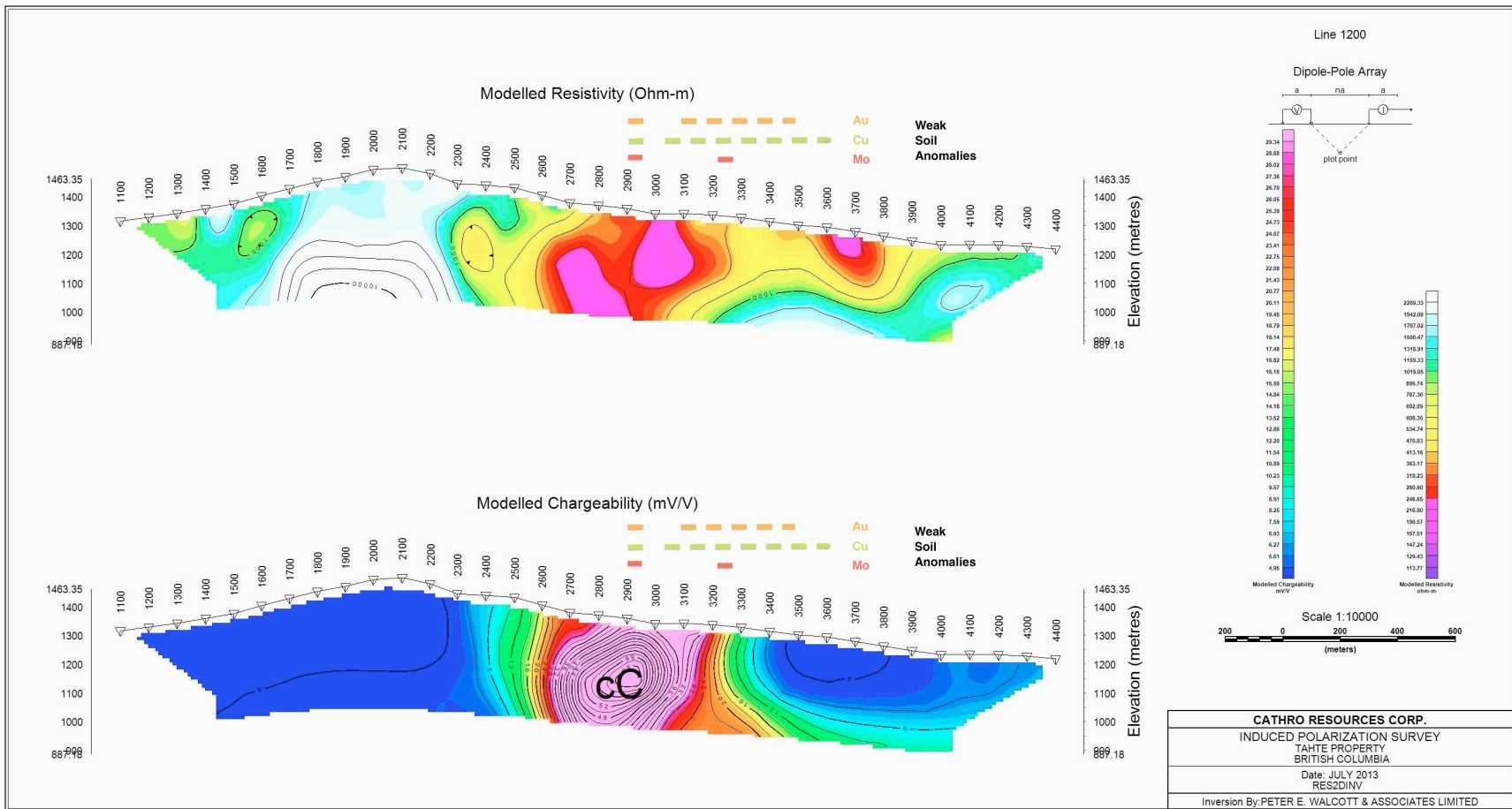

Figure 11. IP Inversions for Line 1200N, including soil geochemical anomalies (modified after Walcott, 2014, Appendix 3).

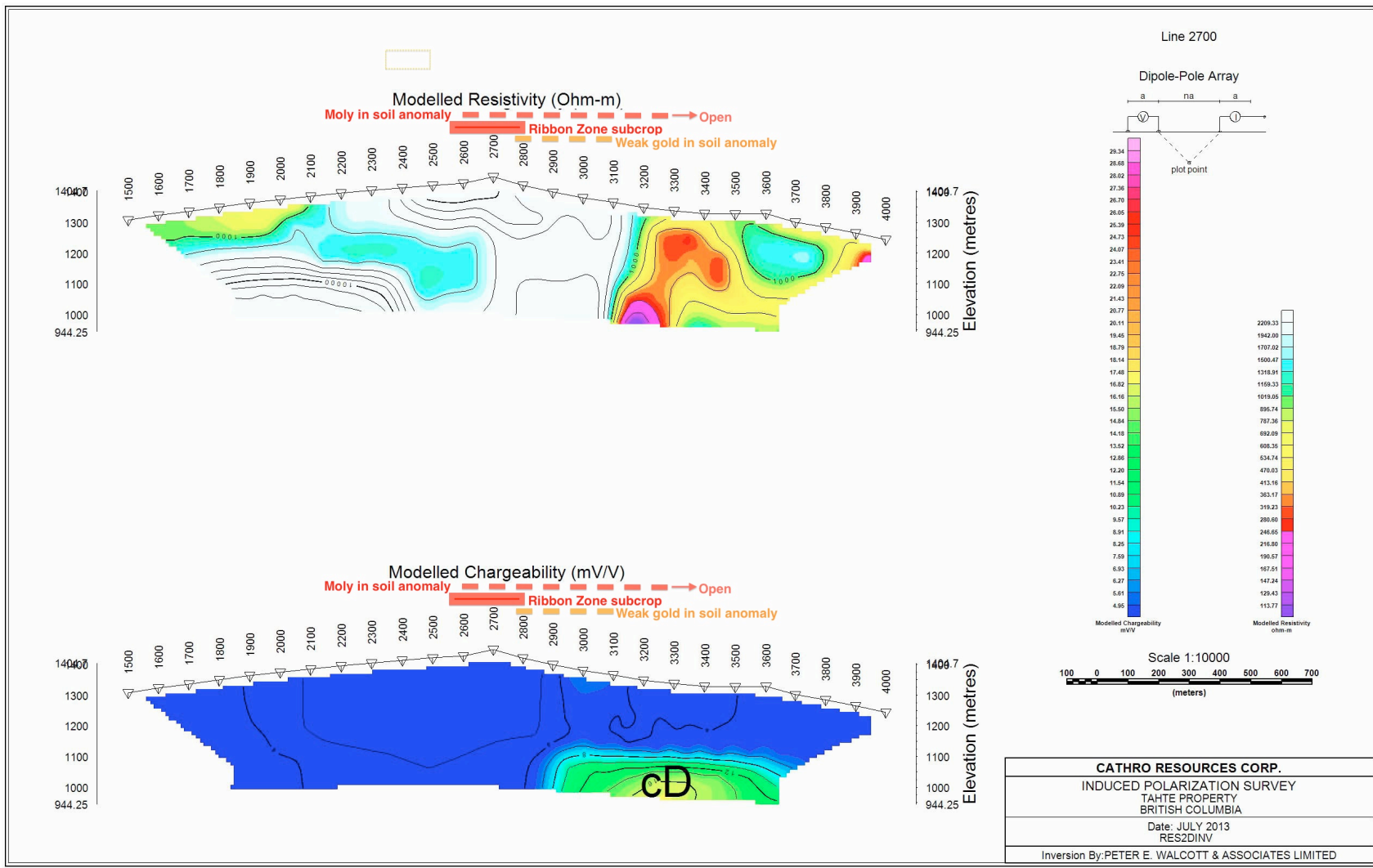

Figure 12. IP Inversions for Line 2700N, including projection of subcropping Ribbon moly zone and soil geochemical anomalies (modified after Walcott, 2014, Appendix 3).

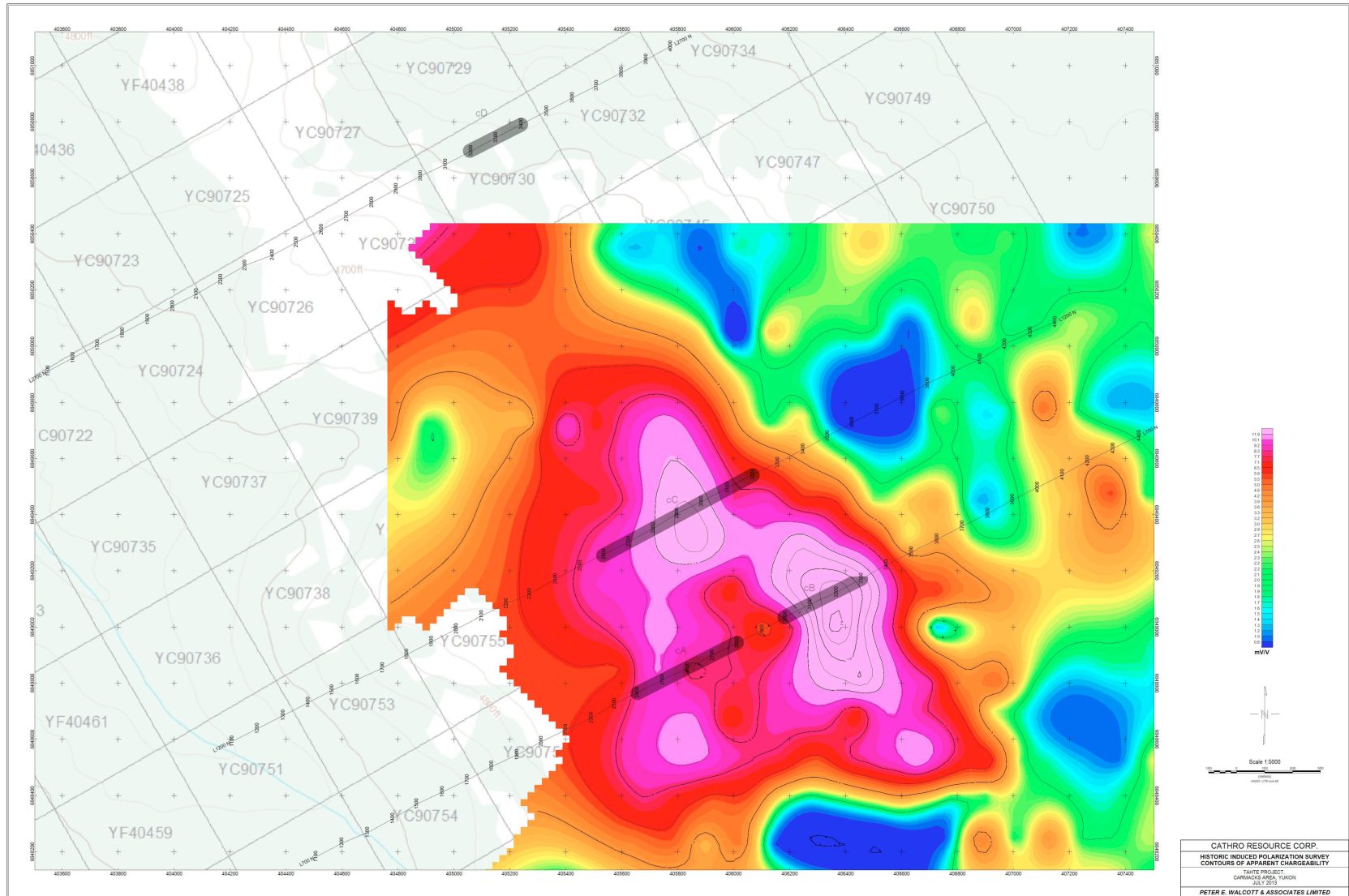

Figure 13. 2014 IP chargeability anomalies in grey, overlain on 1977 Noranda chargeability map (Percent Frequent Effect).

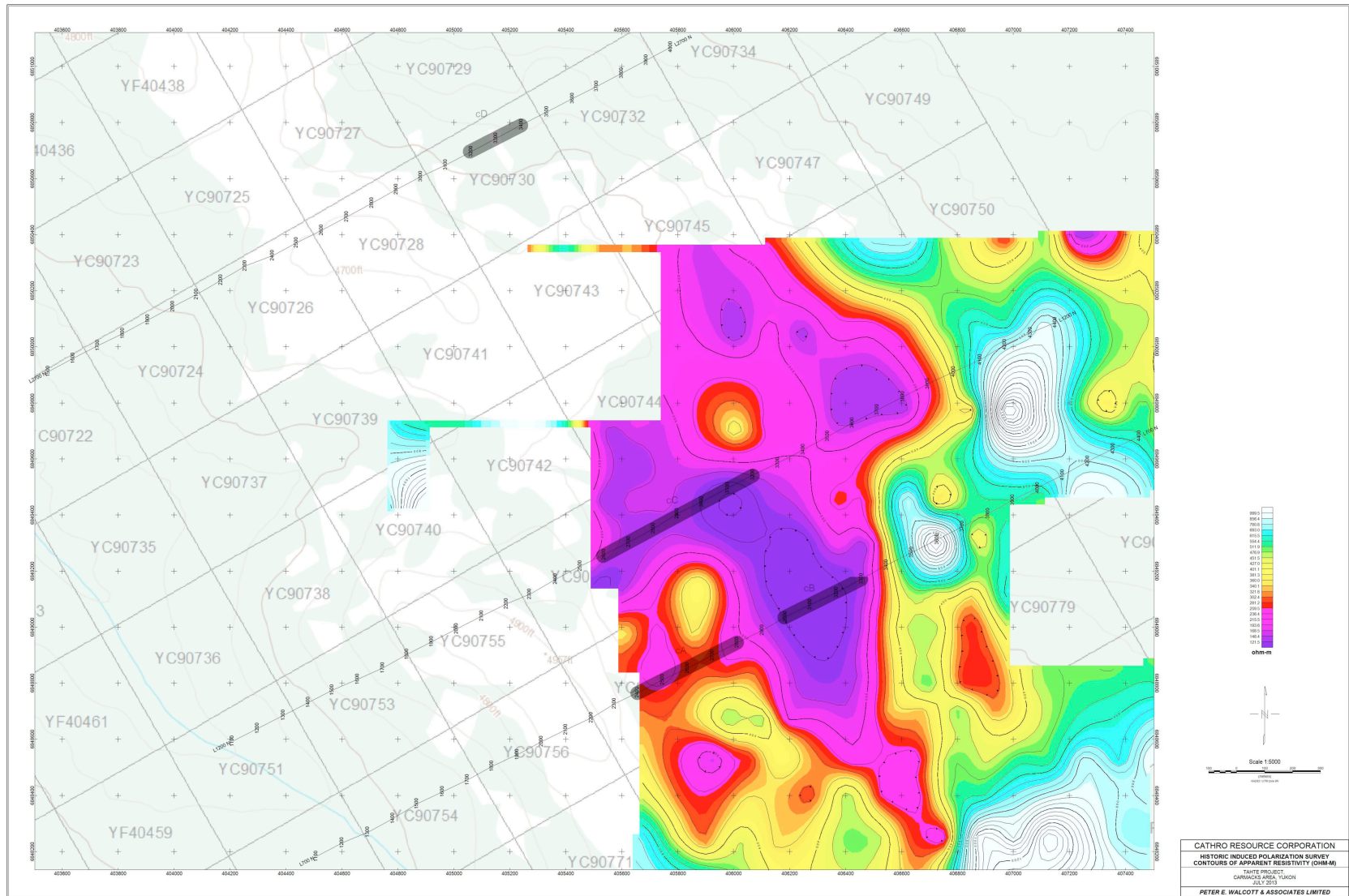

Figure 14. 2014 IP chargeability anomalies in grey, overlain on 1977 Noranda resistivity map.

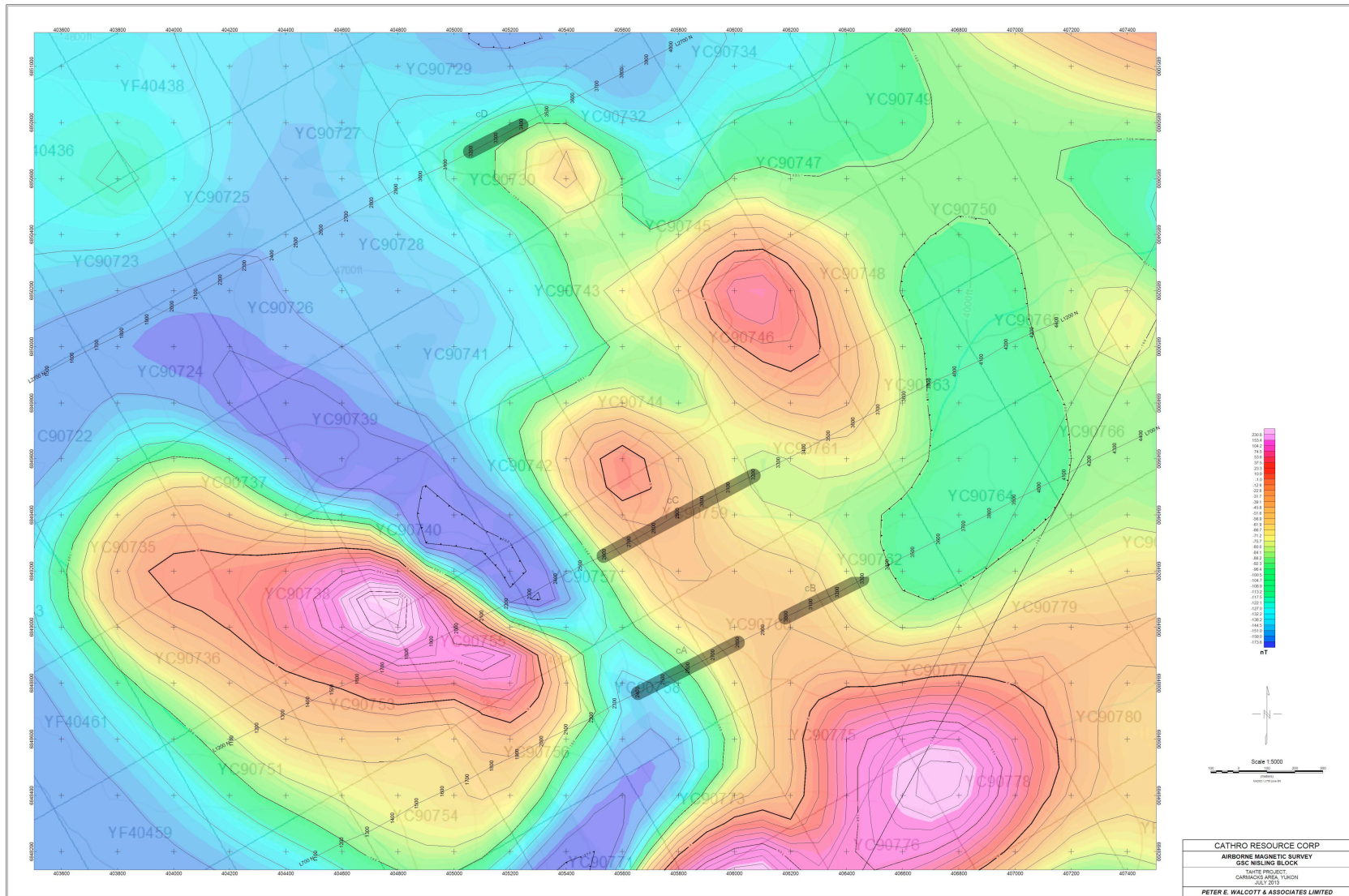

Figure 15. 2014 IP chargeability anomalies in grey, overlain on GSC aeromagnetic total field.

## 11.0 QUALIFICATIONS

I, Michael S. Cathro, of 2560 Telford Place, Kamloops, British Columbia, hereby certify that:

- I have been a registered professional geoscientist with the Association of Professional Engineers and Geoscientists of British Columbia (APEGBC) since 1992 (Reg.# 19093).
- I am a graduate of Queens University, Kingston, Ontario with a B.Sc (Honours) in Geological Sciences (1984), and a graduate of the Colorado School of Mines, Golden, Colorado with a M.Sc. in Geology (1992).
- I am presently employed as a consulting geologist and Vice-President of Virginia Energy Resources Inc., and Vice President of Exploration for Anthem Resources Inc.
- I am the owner and President of Cathro Resources Corp., which is the registered owner of the Tahte property.
- I have been working as a professional geologist in mineral exploration, exploration management, geological research, and administration of mine and exploration permitting and compliance on a semi-continuous basis since 1984.
- I participated in the field work on the property from July 12 to 22, 2013.



Michael S. Cathro, M.Sc., P.Geo. (British Columbia #19093)  
February 1, 2014

## 12.0 REFERENCES

Cathro, M.S., 2013: Geochemical and Prospecting Report on the Tahte Property, Yukon Assessment Report.

Cathro, M.S. and Pautler, J., 2011: Geochemical, Prospecting and Drill Core Re-Sampling Report on the Tahte Property. Yukon Assessment Report.

Fairbank, B, Bradish, L, and Fenton, G, 1977: Combined Geological and Geophysical Report on the Tah 1-42 Mineral Claims, 115H/15, Noranda Exploration Company, Limited. Yukon Assessment Report #090265.

Heberlein, D.R. and Samson, H., 2010: An assessment of Soil Geochemical Methods for Detecting Copper-Gold Porphyry Mineralization through Quaternary Glaciofluvial Sediments at the Kwanika Central Zone, North-Central British Columbia, Geoscience BC Report 2010-03, 89 pages.

Lambert, E., 1989: Prospecting Report on the Nick III Claim Group, Kirkland Creek, Yukon. Golden Quail Resources Ltd. Yukon Assessment Report #92775.

Macdonald, G., 1980: Diamond Drilling Assessment Report, Tah 1-42 Mineral Claims, 115H15, Noranda Exploration Company Limited. Yukon Assessment Report #09814.

## Appendix 1

### Soil and Rock Sample Descriptions and Results for Key Elements

2013 Tahte rock descriptions and key analyses

Sample #	Nad83 Z	E	N	Elev ft	Media	Type	Description	SAMPLE #	Au ppm (25 g ICP-MS)	Ag ppm	As ppm	Cu ppm	Fe %	Hg ppm	Mo ppm	Pb ppm	S %	Sb ppm	W ppm	Zn ppm	Certificate #
T13R006	8	405270	6848569	4782	rock	Subcrop-felsenmeer	30 by 30 cm block of rusty, vuggy weathering qtz vein; trace to 1% fx moly; hosted by quartz monzonite porphyry	T13R006	0.001	0.08	2.1	1.8	0.59	0.01	287	4.5	0.06	0.15	0.025	2	WH13130969
T13R010	8	405474	6849123	4772	rock	Subcrop-felsenmeer	Orange-banded qtz vein boulder; ~15 cm wide; no obvious sulphides; at N nose of large clay-alt'd qtz monzonite porphyry area, hosted by coarse QM	T13R010	0.001	0.06	3.4	3.8	0.81	0.005	1.13	4.8	0.18	0.36	0.05	1	WH13130969
T13R012	8	405190	6850093	4713	rock	Subcrop-felsenmeer	Quartz boulder 40x30x30 cm, orange weathering, trace MoS2	T13R012	0.005	0.23	3.1	2.3	0.6	0.01	409	2.3	0.07	0.47	0.14	1	WH13130969

Notes: Au by ALS method Au-TL43 (25 g aqua regia and ICP-MS)  
 All other elements by ALS method ME-MS41 (0.5 g aqua regia and ICP-MS or ICP-AES)  
 Below detection values highlighted green and replaced by value 1/2 of detection limit (e.g. Au ppm given 0.1 instead of <0.2 ppm)  
 Anomalous moly values

2014 Tahte soil descriptions and analytical results

Sample #	NAD 83 Z	E	N	Elev	Media	Depth cm	Horizon	Colour	Texture	Comments	SAMPLE #	Au ppm (25 g ICP-MS)	Ag ppm	As ppm	Cu ppm	Fe %	Hg ppm	Mo ppm	Pb ppm	Sb ppm	W ppm	Zn ppm	Certificate#
T135001	8	406801	684999	4087	soil	30	B	br	silt-sand	rich brown	T135001	0.003	0.06	8.7	23.1	2.18	0.05	0.71	6.6	0.37	0.15	43 WH3131710	
T135002	8	406700	684995	4166	soil	30	B	or-br	silt-sand	under 20 cm white ash	T135002	0.002	0.15	7.9	21.1	2.77	0.03	0.96	7.8	0.34	0.19	46 WH3131710	
T135003	8	406600	685000	4203	soil	30	A	d, br	humus-silt	organic permafrost	T135003	0.002	0.35	3.3	32	3.18	0.17	2.07	1.8	0.32	0.12	96 WH3131710	
T135004	8	406499	684997	4235	soil	40	B	m, br	sand	under grey sandy loess	T135004	0.002	0.23	6.1	20.5	2.98	0.08	1.34	9.1	0.33	0.08	44 WH3131710	
T135005	8	406399	684998	4261	soil	40	A	m, br	silt-humus	organic permafrost	T135005	0.002	0.53	2.8	41.5	1.62	0.17	1.8	7.3	0.48	0.09	38 WH3131710	
T135006	8	406296	685002	4313	soil	20	B	or-br	sand	rocky	T135006	0.001	0.06	8.3	15.3	3.25	0.03	1.11	10.7	0.29	0.21	61 WH3131710	
T135007	8	406207	684998	4373	soil	20	B	or-br	sand	rocky; fsp porph	(Carma) T135007	0.001	0.13	8.3	17.4	2.92	0.06	0.95	13.5	0.31	0.31	74 WH3131710	
T135008	8	406097	685000	4447	soil	25	B	l, br	silt-sand		T135008	0.006	0.17	5.9	9.7	2.58	0.01	0.92	13.7	0.24	0.19	82 WH3131710	
T135009	8	406001	685002	4499	soil	20	B	br	silt-sand	frost boil	T135009	0.002	0.04	4	14	2.6	0.005	0.76	8.9	0.23	0.1	82 WH3131710	
T135010	8	405894	684999	4557	soil	15	B	or-br	silt-sand-rock		T135010	0.003	0.34	11.9	25.2	5.1	0.06	2.82	20.8	0.48	0.35	130 WH3131710	
T135011	8	405899	684990	4516	soil	15	B	or-br	silt-sand-rock	foliated granodiorite an	T135011	0.005	0.46	8.8	29	3.56	0.04	1.84	12.5	0.44	0.27	118 WH3131710	
T135012	8	405900	684976	4518	soil	15	B	or-br	silt-sand-rock	foliated granodiorite an	T135012	0.009	0.87	10.6	29.7	3.68	0.04	1.49	17.1	0.45	0.22	168 WH3131710	
T135013	8	405892	6849652	4468	soil	20	B	or-br	sand		T135013	0.007	0.23	10.7	21.9	3.46	0.03	1.49	11.6	0.34	0.35	85 WH3131710	
T135014	8	405903	6849540	4424	soil	30	B	or-br	sand		T135014	0.009	0.18	14.9	43.6	4.72	0.03	2.7	24	0.56	0.26	104 WH3131710	
T135015	8	405303	6850000	4673	soil	15	B-C	br	sand	qtz monz porphyry	T135015	0.004	0.15	7.5	19.6	1.94	0.03	7.91	16.4	0.38	0.14	41 WH3131710	
T135016	8	404858	6850590	4566	soil	30	B	br	silt	permafrost	T135016	0.019	1.25	9.3	21.2	1.57	0.14	8.29	60.4	0.95	0.11	63 WH3131710	
T135017	8	404934	6850637	4522	soil	20	B	or-br	silt-sand	feisenmeer; qtz monz p	T135017	0.003	0.46	16.5	17.4	2.82	0.04	5.02	62.2	1.27	0.29	82 WH3131710	
T135018	8	405036	6850677	4481	soil	20	B	or-br	silt-sand	feisenmeer; qtz monz p	T135018	0.01	0.49	11.5	14.5	2.05	0.31	9.58	82.7	0.82	0.23	188 WH3131710	
T135019	8	405123	6850729	4435	soil	30	B	br	silt-sand	permafrost	T135019	0.004	0.9	3.7	17.9	2.14	0.07	3.14	8.3	0.4	0.05	27 WH3131710	
T135020	8	405228	6850496	4544	soil	30	B	br	silt-sand	partly frozen	T135020	0.014	1.41	22.8	25.9	2.27	0.11	5.77	104	0.79	0.12	112 WH3131710	
T135021	8	405135	6850446	4575	soil	30	B	br	silt-sand	wet	T135021	0.011	1.19	13.9	14.3	2.02	0.11	7.78	80.3	0.69	0.15	69 WH3131710	
T135022	8	405045	6850419	4605	soil	40	B	br	silt-sand	frozen	T135022	0.028	2.04	56.6	48.7	4.12	0.22	17.5	127	2.79	0.23	168 WH3131710	
T135023	8	405202	6850221	4702	soil	15	B-C	or-br	silt-sand	qtz and qtz monz porph	T135023	0.004	0.45	15	20.5	2.77	0.05	4.1	42.1	0.69	0.19	81 WH3131710	
T135024	8	405114	6850178	4724	soil	15	B-C	or-br	sand	qtz and qtz monz porph	T135024	0.003	0.69	15.6	12.2	2.39	0.05	3.67	60.6	1.33	0.19	41 WH3131710	
T135025	8	405026	6850129	4731	soil	20	C	or-br	sand	qtz and qtz monz porph	T135025	0.006	0.71	14.2	16.2	2.84	0.05	1.23	19.3	0.56	0.21	80 WH3131710	
T135026	8	404937	6850077	4686	soil	20	C	or-br	sand	qtz and qtz monz porph	T135026	0.021	0.7	17.3	12.2	1.83	0.03	2.14	35.2	0.62	0.12	101 WH3131710	
T135027	8	404850	6850031	4646	soil	20	C	or-br	sand	finer clay and qtz monz	T135027	0.01	0.23	9	20.5	2.94	0.02	2.03	46.6	0.3	0.07	218 WH3131710	
T135028	8	406033	6849551	4536	soil	20	B	or-br	silt-sand	foliated granodiorite	T135028	0.03	0.23	7.6	52.3	4.52	0.03	1.63	22.8	0.45	0.13	204 WH3131710	
T135029	8	406099	6849602	4417	soil	20	B	or-br	sand	fine-grained granodiorite	T135029	0.035	0.82	12	41.7	4.44	0.04	2.27	20.8	0.45	0.11	154 WH3131710	
T135030	8	406190	6849644	4359	soil	25	B	br	sand-rock	foliated granodiorite	T135030	0.013	0.53	7.1	39.7	3.64	0.04	2.66	12.4	0.37	0.14	167 WH3131710	
T135031	8	406282	6849689	4321	soil	25	B	br	sand-rock	foliated granodiorite	T135031	0.018	0.4	5.9	28.5	3.32	0.04	2.11	22.8	0.3	0.13	124 WH3131710	
T135032	8	406381	6849733	4283	soil	25	B	br	sand-rock	frost boil	T135032	0.008	0.09	5.2	22.2	2.89	0.01	1.49	7.1	0.27	0.16	91 WH3131710	
T135033	8	406458	6849776	4259	soil	20	B	or-br	sand-rock	frost boil	T135033	0.006	0.08	3.4	17.2	2.3	0.01	1.51	8.1	0.27	0.17	103 WH3131710	
T135034	8	406546	6849822	4209	soil	30	B	d, br	silt-sand	frozen	T135034	0.003	0.3	7	25.6	2.39	0.06	1.05	2.8	0.23	0.09	15 WH3131710	
T135035	8	405293	6850269	4656	soil	20	B	yel-or	sand	rusty monz	T135035	0.008	0.48	12.5	20.7	1.95	0.04	5.19	41	0.88	0.11	61 WH3131710	
T135036	8	405377	6850314	4636	soil	20	B	or-br	sand	qtz monzonite, foliated	T135036	0.004	0.34	50.4	42.5	4.22	0.05	43.7	40.8	1.26	0.12	193 WH3131710	
T135037	8	405480	6850373	4634	soil	20	B-C	or-br	sand	grey fine-med grained f	T135037	0.004	0.12	9.7	20.7	3.61	0.04	2.82	15.1	0.37	0.16	67 WH3131710	
T135038	8	405551	6850426	4592	soil	20	B-C	or-br	sand	porphyry	T135038	0.004	0.05	4.4	12.7	2.68	0.01	1.85	9.3	0.24	0.08	54 WH3131710	
T135039	8	405642	6850463	4554	soil	20	B-C	or-br	sand	qtz and qtz monz porph	T135039	0.002	0.05	4.1	18.2	4.14	0.03	1.6	9.6	0.41	0.07	63 WH3131710	
T135040	8	405823	6850553	4425	soil	20	B-C	or-br	sand	qtz and qtz monz porph	T135040	0.003	0.13	5.5	87.4	6.05	0.04	5.92	13.1	0.26	0.17	204 WH3131710	
T135041	8	405913	6850605	4356	soil	20	B	br	sand	mossy and rocky	T135041	0.002	0.05	5.8	21.6	3.63	0.02	1.73	9.2	0.26	0.17	87 WH3131710	
T135042	8	406102	6850396	4380	soil	30	B	or-br	sand	mossy	T135042	0.002	0.12	6.1	21.3	3.36	0.02	4.52	10.5	0.28	0.16	60 WH3131710	
T135043	8	406011	6850347	4435	soil	30	B	or-br	sand	mossy	T135043	0.002	0.05	5.1	15.3	3.63	0.02	1.86	13.6	0.22	0.17	108 WH3131710	
T135044	8	405927	6850308	4481	soil	25	B	or-br	sand	mossy	T135044	0.002	0.05	5.4	14.4	3.65	0.01	2.43	9.6	0.27	0.2	87 WH3131710	
T135045	8	405837	6850260	4529	soil	30	B	or-br	sand	mossy	T135045	0.001	0.05	1.8	6.6	2.63	0.01	0.79	6.1	0.11	0.07	42 WH3131710	
T135046	8	405743	6850211	4574	soil	30	B	tan-br	silt-sand	loess?	T135046	0.003	0.19	6.8	14.4	3.09	0.03	1.98	23	0.31	0.46	83 WH3131710	
T135047	8	405650	6850162	4637	soil	20	B-C	or-br	sand-rock	foliated granodiorite, qt	T135047	0.007	0.33	10.4	24.6	4	0.03	2.2	40.3	0.44	0.17	261 WH3131710	
T135048	8	405565	6850121	4641	soil	20	B	or-br	sand-rock	foliated granodiorite, qt	T135048	0.022	1.08	14.6	50.3	7.29	0.15	1.17	44.7	0.82	0.07	387 WH3131710	
T135049	8	405481	6850077	4657	soil	20	B-C	or-br	sand-rock	clay-silt'd qtz monzonite	T135049	0.005	0.34	9.8	24.6	3.2	0.04	4.53	10.5	0.41	0.23	72 WH3131710	
T135050	8	405391	6850026	4665	soil	20	B-C	or-br	sand-rock	float of qtz monz porph	T135050	0.004	0.26	8.5	19.3	2.27	0.04	8.65	13.3	0.48	0.16	33 WH3131710	
T135051	8	405217	6849937	4662	soil	20	B-C	l, br	sand-rock	float of qtz monz porph	T135051	0.023	0.7	13	19.6	1.84	0.03	16.95	93.1	0.83	0.11	43 WH3131710	
T135052	8	405122	6849906	4659	soil	20	B-C	or-br	sand-rock	qtz and qtz monz porph	T135052	0.012	0.48	15.3	28.9	2.66	0.03	1.91	4.9	0.66	0.16	130 WH3131710	
T135053	8	405031	6849856	4644	soil	20	B-C	or-br	sand-rock	qtz and qtz monz porph	T135053	0.012	0.52	11.6	38.3	2.29	0.03	1.29	33.3	0.64	0.15	156 WH3131710	
T135054	8	405123	6849639	4641	soil	35	B	or-br	silt-sand	rocky; QM with orange	T135054	0.005	0.29	4.2	8.6	1.21	0.05	0.85	18.7	0.27	0.14	72 WH3131710	
T135055	8	405210	6849700	4645	soil	25	B-C	tan-br	silt-sand	frost boil	T135055	0.005	0.2	9.5	25	2.47	0.02	3.49	15.5	0.43	0.14	62 WH3131710	
T135056	8	405297	6849748	4644	soil	25	B-C	or-br	clay-sand	frost boil; qtz and qtz m	T135056	0.01	0.28	11.2	26	2.56	0.04	5.26	22.3	0.5	0.13	58 WH3131710	
T135057	8	405386	6849794	4637	soil	25	B-C	or-br	clay-silt-sand	frost boil; qtz and qtz m	T135057	0.011	0.35	13.8	28.8	2.17	0.04	31.8	30.7</				

Appendix 2  
Laboratory Certificates



ALS Canada Ltd.  
 2103 Dollarton Hwy  
 North Vancouver BC V7H 0A7  
 Phone: 604 984 0221 Fax: 604 984 0218 www.alsglobal.com

To: CATHRO RESOURCES  
 2560 TELFORD PLACE  
 KAMLOOPS BC V1S 0A3

Page: 1  
 Finalized Date: 2- AUG- 2013  
 Account: CATRES

**CERTIFICATE WH13130969**

Project: Tahte  
 P.O. No.:  
 This report is for 3 Rock samples submitted to our lab in Whitehorse, YT, Canada on 21-JUL-2013.  
 The following have access to data associated with this certificate:  
 MIKE CATHRO

SAMPLE PREPARATION	
ALS CODE	DESCRIPTION
WEI- 21	Received Sample Weight
LOG- 22	Sample login - Rcd w/o BarCode
CRU- QC	Crushing QC Test
PUL- QC	Pulverizing QC Test
CRU- 31	Fine crushing - 70% <2mm
SPL- 21	Split sample - riffle splitter
PUL- 31	Pulverize split to 85% <75 um

ANALYTICAL PROCEDURES		
ALS CODE	DESCRIPTION	INSTRUMENT
Au- TL43	Trace Level Au - 25g AR	ICP- MS
ME- MS41	51 anal. aqua regia ICPMS	

*Tahte, Yukon  
 2013 rock samples.  
 (3 samples)*

To: CATHRO RESOURCES  
 ATTN: MIKE CATHRO  
 2560 TELFORD PLACE  
 KAMLOOPS BC V1S 0A3

This is the Final Report and supersedes any preliminary report with this certificate number. Results apply to samples as submitted. All pages of this report have been checked and approved for release.

\*\*\*\*\* See Appendix Page for comments regarding this certificate \*\*\*\*\*

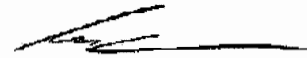
Signature:   
 Colin Ramshaw, Vancouver Laboratory Manager



ALS Canada Ltd.  
 2103 Dollarton Hwy  
 North Vancouver BC V7H 0A7  
 Phone: 604 984 0221 Fax: 604 984 0218 www.alsglobal.com

To: CATHRO RESOURCES  
 2560 TELFORD PLACE  
 KAMLOOPS BC V1S 0A3

Page: 2 - A  
 Total # Pages: 2 (A - D)  
 Plus Appendix Pages  
 Finalized Date: 2- AUG- 2013  
 Account: CATRES

Project: Tahte

**CERTIFICATE OF ANALYSIS WH13130969**

Sample Description	Method Analyte Units LOR	WEI- 21	Au- TL43	ME- MS41	ME- MS41	ME- MS41	ME- MS41	ME- MS41	ME- MS41	ME- MS41	ME- MS41	ME- MS41	ME- MS41	ME- MS41	ME- MS41	
		Recvd Wt. kg	Au ppm	Ag ppm	Al %	As ppm	Au ppm	B ppm	Ba ppm	Be ppm	Bi ppm	Ca %	Cd ppm	Ce ppm	Co ppm	Cr ppm
T13R006		1.00	0.001	0.08	0.02	2.1	<0.2	<10	60	<0.05	0.06	0.01	0.02	0.26	0.3	11
T13R010		0.79	0.001	0.06	0.20	3.4	<0.2	<10	630	0.07	0.09	0.01	0.02	1.60	0.2	11
T13R012		0.64	0.005	0.23	0.01	3.1	<0.2	<10	120	<0.05	0.15	0.01	<0.5	0.19	0.3	24



ALS Canada Ltd.  
 2103 Dollarton Hwy  
 North Vancouver BC V7H 0A7  
 Phone: 604 984 0221 Fax: 604 984 0218 www.alsglobal.com

To: CATHRO RESOURCES  
 2560 TELFORD PLACE  
 KAMLOOPS BC V1S 0A3

Page: 2 - B  
 Total # Pages: 2 (A - D)  
 Plus Appendix Pages  
 Finalized Date: 2- AUG- 2013  
 Account: CATRES

Project: Tahte

**CERTIFICATE OF ANALYSIS WH13130969**

Sample Description	Method Analyte Units LOR	ME- MS41	ME- MS41	ME- MS41	ME- MS41	ME- MS41	ME- MS41	ME- MS41	ME- MS41	ME- MS41	ME- MS41	ME- MS41	ME- MS41	ME- MS41	ME- MS41	ME- MS41
		Cs ppm	Cu ppm	Fe %	Ga ppm	Ge ppm	Hf ppm	Hg ppm	In ppm	K %	La ppm	Li ppm	Mg %	Mn ppm	Mo ppm	Na %
T13R006		0.06	1.8	0.59	0.12	<0.05	<0.02	0.01	0.005	0.01	<0.2	0.2	<0.01	48	287	0.01
T13R010		0.07	3.8	0.81	0.78	<0.05	0.02	<0.01	<0.005	0.17	0.8	0.3	0.01	42	1.13	0.04
T13R012		<0.05	2.3	0.60	0.10	<0.05	<0.02	0.01	<0.005	0.02	<0.2	0.1	<0.01	51	409	0.01

\*\*\*\*\* See Appendix Page for comments regarding this certificate \*\*\*\*\*



ALS Canada Ltd.  
 2103 Dollarton Hwy  
 North Vancouver BC V7H 0A7  
 Phone: 604 984 0221 Fax: 604 984 0218 www.alsglobal.com

To: CATHRO RESOURCES  
 2560 TELFORD PLACE  
 KAMLOOPS BC V1S 0A3

Page: 2 - C  
 Total # Pages: 2 (A - D)  
 Plus Appendix Pages  
 Finalized Date: 2- AUG- 2013  
 Account: CATRES

Project: Tahte

**CERTIFICATE OF ANALYSIS WH13130969**

Sample Description	Method Analyte Units LOR	ME- MS41	ME- MS41	ME- MS41	ME- MS41	ME- MS41	ME- MS41	ME- MS41	ME- MS41	ME- MS41	ME- MS41	ME- MS41	ME- MS41	ME- MS41	ME- MS41	ME- MS41
		Nb ppm	Ni ppm	P ppm	Pb ppm	Rb ppm	Re ppm	S %	Sb ppm	Sc ppm	Se ppm	Sn ppm	Sr ppm	Ta ppm	Te ppm	Th ppm
T13R006		0.05	1.8	10	4.5	0.3	0.129	0.06	0.15	0.1	<0.2	<0.2	2.1	<0.01	0.02	<0.2
T13R010		0.07	1.2	40	4.8	3.9	<0.001	0.18	0.36	0.2	0.3	0.2	19.7	<0.01	0.04	0.6
T13R012		0.05	1.7	10	2.3	0.2	0.059	0.07	0.47	<0.1	<0.2	<0.2	3.3	<0.01	0.05	<0.2

\*\*\*\*\* See Appendix Page for comments regarding this certificate \*\*\*\*\*



ALS Canada Ltd.  
 2103 Dollarton Hwy  
 North Vancouver BC V7H 0A7  
 Phone: 604 984 0221 Fax: 604 984 0218 www.alsglobal.com

To: CATHRO RESOURCES  
 2560 TELFORD PLACE  
 KAMLOOPS BC V1S 0A3

Page: 2 - D  
 Total # Pages: 2 (A - D)  
 Plus Appendix Pages  
 Finalized Date: 2- AUG- 2013  
 Account: CATRES

Project: Tahte

**CERTIFICATE OF ANALYSIS WH13130969**

Sample Description	Method Analyte Units LOR	ME- MS41	ME- MS41	ME- MS41	ME- MS41	ME- MS41	ME- MS41	ME- MS41	ME- MS41
		Ti %	Ti ppm	U ppm	V ppm	W ppm	Y ppm	Zn ppm	Zr ppm
		0.005	0.02	0.05	1	0.05	0.05	2	0.5
T13R006		<0.005	<0.02	<0.05	<1	<0.05	0.09	2	<0.5
T13R010		<0.005	0.04	0.05	1	0.05	0.44	<2	0.5
T13R012		<0.005	0.02	0.06	<1	0.14	0.08	<2	<0.5

\*\*\*\*\* See Appendix Page for comments regarding this certificate \*\*\*\*\*



ALS Canada Ltd.  
 2103 Dollarton Hwy  
 North Vancouver BC V7H 0A7  
 Phone: 604 984 0221 Fax: 604 984 0218 www.alsglobal.com

To: CATHRO RESOURCES  
 2560 TELFORD PLACE  
 KAMLOOPS BC V1S 0A3

Page: 1  
 Finalized Date: 3- AUG- 2013  
 This copy reported on  
 6- AUG- 2013  
 Account: CATRES

**CERTIFICATE WH13131710**

Project: Tahte  
 P.O. No.:  
 This report is for 73 Soil samples submitted to our lab in Whitehorse, YT, Canada on 21-JUL- 2013.  
 The following have access to data associated with this certificate:  
 MIKE CATHRO

SAMPLE PREPARATION	
ALS CODE	DESCRIPTION
WEI- 21	Received Sample Weight
LOG- 22	Sample login - Rcd w/o BarCode
SCR- 41	Screen to - 180um and save both

ANALYTICAL PROCEDURES		
ALS CODE	DESCRIPTION	INSTRUMENT
Au- TL43	Trace Level Au - 25g AR	ICP- MS
ME- MS41	51 anal. aqua regia ICPMS	

*Tahte, Yukon  
 2013 soils (73 samples)*

To: CATHRO RESOURCES  
 ATTN: MIKE CATHRO  
 2560 TELFORD PLACE  
 KAMLOOPS BC V1S 0A3

This is the Final Report and supersedes any preliminary report with this certificate number. Results apply to samples as submitted. All pages of this report have been checked and approved for release.  
 \*\*\*\*\* See Appendix Page for comments regarding this certificate \*\*\*\*\*

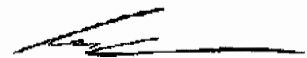
Signature:   
 Colin Ramshaw, Vancouver Laboratory Manager



ALS Canada Ltd.  
 2103 Dollarton Hwy  
 North Vancouver BC V7H 0A7  
 Phone: 604 984 0221 Fax: 604 984 0218 www.alsglobal.com

To: CATHRO RESOURCES  
 2560 TELFORD PLACE  
 KAMLOOPS BC V1S 0A3

Page: 2 - A  
 Total # Pages: 3 (A - D)  
 Plus Appendix Pages  
 Finalized Date: 3- AUG- 2013  
 Account: CATRES

Project: Tahte

**CERTIFICATE OF ANALYSIS WH13131710**

Sample Description	Method Analyte Units LOR	WEI- 21	Au- TL43	ME- MS41	ME- MS41	ME- MS41	ME- MS41	ME- MS41	ME- MS41	ME- MS41	ME- MS41	ME- MS41	ME- MS41	ME- MS41	ME- MS41	ME- MS41
		Recvd Wt. kg	Au ppm	Ag ppm	Al %	As ppm	Au ppm	B ppm	Ba ppm	Be ppm	Bi ppm	Ca %	Cd ppm	Ce ppm	Co ppm	Cr ppm
T13S001		0.53	0.003	0.06	1.31	8.7	<0.2	<10	190	0.45	0.11	0.36	0.10	27.3	7.4	18
T13S002		0.48	0.002	0.15	1.93	7.9	<0.2	<10	260	0.37	0.14	0.18	0.20	17.55	9.1	26
T13S003		0.22	0.002	0.35	0.66	3.3	<0.2	<10	450	0.29	0.06	1.89	1.39	16.55	27.8	8
T13S004		0.52	0.002	0.23	1.33	6.1	<0.2	<10	270	0.44	0.08	0.83	0.36	45.8	21.2	16
T13S005		0.23	0.002	0.53	1.19	2.8	<0.2	<10	380	0.75	0.06	1.94	1.16	75.0	9.5	12
T13S006		0.43	0.001	0.06	2.32	8.3	<0.2	<10	200	0.38	0.14	0.20	0.21	18.10	7.4	29
T13S007		0.48	0.001	0.13	2.24	8.3	<0.2	<10	190	0.45	0.13	0.32	0.38	24.9	8.6	25
T13S008		0.43	0.006	0.17	1.84	5.9	<0.2	<10	110	0.29	0.14	0.33	0.44	18.15	6.8	27
T13S009		0.51	0.002	0.04	1.73	4.0	<0.2	<10	160	0.30	0.11	0.44	0.26	38.4	7.8	18
T13S010		0.51	0.003	0.34	3.35	11.9	<0.2	<10	160	0.78	0.28	0.29	0.48	49.8	21.4	33
T13S011		0.58	0.005	0.46	2.33	8.8	<0.2	<10	100	0.52	0.24	0.21	0.58	35.4	17.5	39
T13S012		0.46	0.009	0.87	2.55	10.6	<0.2	<10	120	0.59	0.23	0.18	0.82	34.5	15.8	34
T13S013		0.41	0.007	0.23	2.09	10.7	<0.2	<10	100	0.44	0.27	0.19	0.48	25.4	8.7	34
T13S014		0.41	0.009	0.18	2.02	14.9	<0.2	<10	110	0.33	0.47	0.13	0.72	19.70	14.3	31
T13S015		0.57	0.004	0.15	1.53	7.5	<0.2	<10	90	0.34	0.19	0.12	0.21	23.0	7.8	20
T13S016		0.28	0.019	1.25	1.16	9.3	<0.2	<10	220	0.23	0.20	0.21	0.67	17.85	4.7	14
T13S017		0.49	0.003	0.46	1.81	16.5	<0.2	<10	100	0.37	0.16	0.13	0.23	17.05	7.0	27
T13S018		0.46	0.010	0.49	1.25	11.5	<0.2	<10	120	0.66	0.12	0.15	1.10	27.0	8.0	22
T13S019		0.38	0.004	0.90	0.43	3.7	<0.2	<10	230	0.33	0.06	0.18	0.88	22.1	66.4	11
T13S020		0.60	0.014	1.41	1.28	22.8	<0.2	<10	130	0.33	0.33	0.17	0.38	19.35	6.4	27
T13S021		0.46	0.011	1.19	1.36	13.9	<0.2	<10	110	0.29	0.22	0.21	0.33	20.5	4.1	22
T13S022		0.32	0.028	2.04	2.52	56.6	<0.2	<10	540	1.24	0.52	0.50	3.45	66.4	31.0	40
T13S023		0.51	0.004	0.45	1.77	15.0	<0.2	<10	130	0.59	0.32	0.13	0.46	24.5	8.1	26
T13S024		0.61	0.003	0.69	1.16	15.6	<0.2	<10	100	0.27	0.75	0.09	0.24	17.05	5.2	19
T13S025		0.48	0.006	0.71	1.79	14.2	<0.2	<10	80	0.51	0.53	0.12	0.25	22.9	8.0	29
T13S026		0.65	0.021	0.70	0.94	17.3	<0.2	<10	80	0.34	0.26	0.11	0.47	19.95	6.7	18
T13S027		0.53	0.010	0.23	1.79	9.0	<0.2	<10	320	0.84	0.13	0.27	0.75	39.5	8.9	20
T13S028		0.57	0.030	0.23	2.90	7.6	<0.2	<10	150	0.49	0.63	0.36	0.82	25.8	21.5	26
T13S029		0.74	0.035	0.82	2.89	12.0	<0.2	<10	190	0.75	0.82	0.20	0.88	18.75	25.7	25
T13S030		0.70	0.013	0.53	2.23	7.1	<0.2	<10	140	0.59	0.36	0.29	0.84	40.0	18.5	29
T13S031		0.71	0.018	0.40	2.18	5.9	0.2	<10	140	0.40	0.22	0.32	0.31	39.6	10.5	29
T13S032		0.77	0.008	0.09	1.66	5.2	<0.2	<10	140	0.32	0.19	0.38	0.31	27.2	10.3	27
T13S033		0.58	0.006	0.08	1.38	3.4	<0.2	<10	120	0.29	0.16	0.39	0.48	32.6	9.1	22
T13S034		0.33	0.003	0.30	0.64	7.0	<0.2	<10	100	0.54	0.06	0.35	0.33	36.3	9.6	8
T13S035		0.74	0.008	0.48	0.90	12.5	<0.2	<10	170	0.34	0.48	0.18	0.55	21.5	4.4	19
T13S036		0.57	0.004	0.34	1.35	50.4	<0.2	<10	120	0.45	0.28	0.17	0.97	38.3	18.6	32
T13S037		0.49	0.004	0.12	2.85	9.7	<0.2	<10	430	0.71	0.32	0.20	0.18	27.8	11.7	31
T13S038		0.55	0.004	0.05	1.19	4.4	<0.2	<10	170	0.37	0.15	0.32	0.19	41.3	8.7	19
T13S039		0.57	0.002	0.05	1.50	4.1	<0.2	<10	60	0.86	0.33	0.11	0.11	27.9	10.1	8
T13S040		0.57	0.003	0.13	3.28	5.5	<0.2	<10	210	1.01	0.23	0.62	0.16	61.2	28.3	35

\*\*\*\* See Appendix Page for comments regarding this certificate \*\*\*\*



ALS Canada Ltd.  
 2103 Dollarton Hwy  
 North Vancouver BC V7H 0A7  
 Phone: 604 984 0221 Fax: 604 984 0218 www.alsglobal.com

To: **CATHRO RESOURCES**  
**2560 TELFORD PLACE**  
**KAMLOOPS BC V1S 0A3**

Page: 2 - B  
 Total # Pages: 3 (A - D)  
 Plus Appendix Pages  
 Finalized Date: 3- AUG- 2013  
 Account: CATRES

Project: Tahte

**CERTIFICATE OF ANALYSIS WH13131710**

Sample Description	Method Analyte Units LOR	ME- MS41	ME- MS41	ME- MS41	ME- MS41	ME- MS41	ME- MS41	ME- MS41	ME- MS41	ME- MS41	ME- MS41	ME- MS41	ME- MS41	ME- MS41	ME- MS41	
		Cs ppm	Cu ppm	Fe %	Ga ppm	Ge ppm	Hf ppm	Hg ppm	In ppm	K %	La ppm	Li ppm	Mg %	Mn ppm	Mo ppm	Na %
T13S001		1.30	23.1	2.18	3.59	<0.05	0.04	0.05	0.024	0.07	11.5	6.5	0.33	521	0.71	0.02
T13S002		1.18	21.1	2.77	6.27	<0.05	0.08	0.03	0.024	0.07	8.0	15.4	0.41	350	0.96	0.02
T13S003		0.14	32.0	3.18	1.61	<0.05	0.05	0.17	0.007	0.03	10.3	0.9	0.11	6750	2.07	0.02
T13S004		0.36	20.5	2.98	4.42	0.07	0.06	0.08	0.021	0.05	20.8	7.3	0.48	2450	1.34	0.02
T13S005		0.28	41.5	1.62	2.47	0.11	0.06	0.17	0.020	0.04	42.0	2.1	0.17	4350	1.80	0.02
T13S006		0.94	15.3	3.25	7.78	<0.05	0.03	0.03	0.029	0.08	8.1	17.5	0.52	338	1.11	0.01
T13S007		0.72	17.4	2.92	6.32	<0.05	<0.02	0.06	0.030	0.11	9.0	15.2	0.57	487	0.95	0.01
T13S008		0.91	9.7	2.58	7.03	<0.05	0.08	0.01	0.022	0.07	9.6	17.4	0.56	287	0.92	0.02
T13S009		0.69	14.0	2.60	5.42	<0.05	0.12	<0.01	0.026	0.08	12.6	10.2	0.67	497	0.76	0.02
T13S010		1.59	25.2	5.10	9.22	0.06	0.04	0.06	0.052	0.26	15.8	19.9	0.90	1130	2.82	0.02
T13S011		1.28	29.0	3.56	6.59	0.06	0.05	0.04	0.047	0.22	14.1	11.0	0.87	778	1.84	0.02
T13S012		1.24	29.7	3.68	7.18	0.05	0.05	0.04	0.048	0.15	13.2	17.7	0.73	609	1.49	0.02
T13S013		1.22	21.9	3.46	7.90	<0.05	0.08	0.03	0.037	0.13	13.2	20.9	0.61	356	1.49	0.02
T13S014		1.10	43.6	4.72	11.50	<0.05	0.03	0.03	0.049	0.13	9.2	11.4	0.57	941	2.70	0.02
T13S015		0.57	19.6	1.94	3.39	<0.05	0.04	0.03	0.033	0.06	8.4	8.6	0.29	268	7.91	0.02
T13S016		1.11	21.2	1.57	3.51	<0.05	<0.02	0.14	0.031	0.06	9.5	4.4	0.19	184	8.29	0.02
T13S017		1.13	17.4	2.82	6.61	<0.05	0.02	0.04	0.027	0.06	7.9	11.2	0.33	383	5.02	0.02
T13S018		0.90	14.5	2.05	3.28	<0.05	0.04	0.31	0.027	0.06	12.9	8.7	0.32	721	9.58	0.02
T13S019		0.21	17.9	2.14	1.83	<0.05	<0.02	0.07	0.022	0.02	7.9	0.7	0.07	7000	3.14	0.03
T13S020		1.45	25.9	2.27	4.53	<0.05	<0.02	0.11	0.047	0.07	9.2	5.7	0.18	148	5.77	0.02
T13S021		1.09	14.3	2.02	4.51	<0.05	<0.02	0.11	0.024	0.07	12.0	7.2	0.33	195	7.78	0.02
T13S022		2.01	48.7	4.12	7.55	0.06	0.02	0.22	0.061	0.13	21.8	9.9	0.34	12550	17.50	0.03
T13S023		0.91	20.5	2.77	5.32	<0.05	0.02	0.05	0.052	0.08	10.6	10.8	0.37	466	4.10	0.02
T13S024		0.99	12.2	2.39	5.71	<0.05	0.02	0.05	0.043	0.10	7.5	7.4	0.24	318	3.67	0.02
T13S025		0.98	16.2	2.84	5.99	<0.05	<0.02	0.05	0.028	0.05	9.6	16.9	0.42	488	1.23	0.02
T13S026		0.67	12.2	1.83	2.89	<0.05	0.03	0.03	0.028	0.07	9.5	5.3	0.25	704	2.14	0.02
T13S027		1.41	20.5	2.94	5.05	<0.05	0.05	0.02	0.039	0.06	16.4	8.3	0.42	1210	2.03	0.01
T13S028		1.25	52.3	4.52	9.40	0.07	0.02	0.03	0.051	0.38	13.1	14.0	1.08	1470	1.63	0.03
T13S029		0.74	41.7	4.44	6.52	<0.05	0.08	0.04	0.047	0.07	8.5	10.6	0.73	1100	2.27	0.02
T13S030		1.13	39.7	3.64	7.66	0.08	0.03	0.04	0.080	0.17	21.7	14.4	0.80	812	2.66	0.02
T13S031		1.20	28.5	3.32	7.87	0.08	0.03	0.04	0.037	0.15	20.7	10.7	0.79	481	2.11	0.02
T13S032		0.96	22.2	2.89	5.87	0.08	0.05	0.01	0.029	0.16	14.8	10.8	0.75	821	1.49	0.02
T13S033		0.72	17.2	2.30	5.01	0.07	0.06	0.01	0.027	0.12	15.7	9.4	0.67	393	1.51	0.02
T13S034		0.18	25.6	2.39	3.10	0.06	0.02	0.06	0.012	0.02	18.2	1.0	0.07	901	1.05	0.03
T13S035		0.66	20.7	1.95	3.44	<0.05	0.03	0.04	0.043	0.08	12.7	6.0	0.27	165	5.19	0.02
T13S036		0.92	42.5	4.22	5.21	0.07	<0.02	0.05	0.044	0.15	18.8	8.0	0.37	952	43.7	0.02
T13S037		1.45	20.7	3.61	8.53	<0.05	0.03	0.04	0.042	0.11	11.3	18.5	0.66	780	2.82	0.02
T13S038		0.52	12.7	2.68	4.26	0.07	0.03	0.01	0.021	0.07	14.3	8.4	0.47	935	1.85	0.02
T13S039		1.38	18.2	4.14	3.66	<0.05	0.02	0.03	0.052	0.11	13.3	4.3	0.17	374	1.60	0.01
T13S040		3.52	87.4	6.05	13.20	0.13	0.07	0.04	0.071	0.42	26.0	27.5	1.38	1080	5.92	0.02

\*\*\*\* See Appendix Page for comments regarding this certificate \*\*\*\*



ALS Canada Ltd.  
 2103 Dollarton Hwy  
 North Vancouver BC V7H 0A7  
 Phone: 604 984 0221 Fax: 604 984 0218 www.alsglobal.com

To: CATHRO RESOURCES  
 2560 TELFORD PLACE  
 KAMLOOPS BC V1S 0A3

Page: 2 - C  
 Total # Pages: 3 (A - D)  
 Plus Appendix Pages  
 Finalized Date: 3- AUG- 2013  
 Account: CATRES

Project: Tahte

**CERTIFICATE OF ANALYSIS WH13131710**

Sample Description	Method Analyte Units LOR	ME- MS41	ME- MS41	ME- MS41	ME- MS41	ME- MS41	ME- MS41	ME- MS41	ME- MS41	ME- MS41	ME- MS41	ME- MS41	ME- MS41	ME- MS41	ME- MS41	ME- MS41
		Nb ppm	Ni ppm	P ppm	Pb ppm	Rb ppm	Re ppm	S %	Sb ppm	Sc ppm	Se ppm	Sn ppm	Sr ppm	Ta ppm	Te ppm	Th ppm
T135001		0.67	10.9	670	6.6	9.1	<0.001	0.01	0.37	4.2	0.3	0.4	37.9	<0.01	0.02	2.4
T135002		1.57	15.8	320	7.8	13.4	<0.001	0.02	0.34	3.4	0.2	0.6	20.9	<0.01	0.04	2.2
T135003		0.25	10.7	1650	1.8	0.9	0.001	0.22	0.32	0.8	1.0	<0.2	98.3	<0.01	0.03	0.2
T135004		0.57	9.1	1060	9.1	4.7	<0.001	0.11	0.33	3.1	0.8	0.3	53.5	<0.01	0.06	1.1
T135005		0.28	10.8	1770	7.3	1.6	<0.001	0.21	0.48	1.1	2.2	<0.2	119.5	<0.01	0.04	0.2
T135006		1.46	13.4	400	10.7	8.6	<0.001	0.02	0.29	3.9	0.3	0.6	20.0	<0.01	0.05	1.9
T135007		1.01	16.0	730	13.5	8.9	<0.001	0.04	0.31	2.8	0.4	0.5	25.3	<0.01	0.04	0.7
T135008		1.65	12.5	330	13.7	13.2	<0.001	0.02	0.24	3.7	0.4	0.6	24.1	<0.01	0.04	2.1
T135009		0.53	12.0	810	8.9	8.9	<0.001	0.01	0.23	4.2	0.3	0.4	23.2	<0.01	0.06	3.0
T135010		1.91	21.7	860	20.8	31.2	<0.001	0.06	0.48	7.4	0.7	0.8	23.6	<0.01	0.21	4.4
T135011		1.50	25.6	520	12.5	26.5	<0.001	0.04	0.44	5.4	0.6	0.6	15.7	<0.01	0.28	4.9
T135012		1.75	22.2	490	17.1	20.2	<0.001	0.04	0.45	5.2	0.5	0.7	15.9	0.01	0.27	5.0
T135013		1.94	15.6	350	11.6	17.7	<0.001	0.04	0.34	4.7	0.5	0.7	20.1	<0.01	0.13	3.5
T135014		1.89	14.2	580	24.0	18.9	<0.001	0.07	0.56	4.2	0.7	0.7	23.8	<0.01	0.28	2.4
T135015		0.98	15.3	300	16.4	5.2	<0.001	0.06	0.38	2.1	0.3	0.3	16.9	0.01	0.07	1.9
T135016		0.50	7.9	970	60.4	8.1	0.001	0.10	0.95	1.0	0.4	0.3	25.9	<0.01	0.12	<0.2
T135017		1.35	13.2	390	62.2	7.4	<0.001	0.05	1.27	2.4	0.3	0.6	15.1	0.01	0.08	0.8
T135018		0.88	12.9	340	82.7	7.0	<0.001	0.03	0.82	3.2	0.4	0.3	14.6	<0.01	0.10	2.8
T135019		0.10	5.8	920	8.3	1.3	<0.001	0.10	0.40	0.7	0.7	<0.2	22.4	<0.01	0.08	<0.2
T135020		0.43	8.6	910	104.0	12.1	<0.001	0.09	0.79	1.7	0.7	0.4	14.2	<0.01	0.24	0.3
T135021		0.81	10.1	630	80.3	10.0	<0.001	0.06	0.69	2.1	0.5	0.4	22.0	<0.01	0.33	0.5
T135022		0.91	21.3	1470	127.0	16.4	<0.001	0.23	2.79	4.4	2.3	0.5	64.2	<0.01	0.46	1.0
T135023		1.28	16.6	340	42.1	8.7	<0.001	0.09	0.69	2.9	0.5	0.5	18.2	<0.01	0.20	2.0
T135024		1.37	9.9	340	60.6	9.2	<0.001	0.12	1.33	2.0	0.6	0.5	13.2	<0.01	0.19	1.7
T135025		1.39	16.1	380	19.3	7.9	<0.001	0.04	0.56	3.0	0.5	0.5	14.0	0.01	0.11	1.2
T135026		0.86	9.9	290	35.2	5.6	<0.001	0.06	0.62	2.4	0.4	0.3	15.6	<0.01	0.26	1.9
T135027		0.42	9.6	390	46.6	6.1	<0.001	0.02	0.30	5.4	0.4	0.3	33.8	<0.01	0.10	2.7
T135028		1.49	15.6	700	22.8	32.8	0.001	0.08	0.43	6.3	0.8	0.8	41.6	<0.01	0.46	4.2
T135029		0.87	16.0	810	20.8	8.3	<0.001	0.03	0.45	4.0	1.0	0.4	60.0	<0.01	0.58	2.3
T135030		1.25	16.2	590	12.4	22.4	<0.001	0.03	0.37	7.1	0.8	0.8	25.4	<0.01	0.46	4.9
T135031		1.35	14.5	500	22.8	23.7	<0.001	0.01	0.30	7.3	0.8	0.7	23.0	<0.01	0.15	4.7
T135032		1.30	14.2	640	7.1	18.4	0.001	0.02	0.27	4.9	0.5	0.6	26.4	<0.01	0.11	3.9
T135033		1.11	10.7	670	8.1	14.0	0.001	0.01	0.27	4.4	0.4	0.5	23.8	<0.01	0.10	4.3
T135034		0.33	5.8	770	2.8	1.2	<0.001	0.08	0.23	1.9	0.9	<0.2	27.3	<0.01	0.06	0.4
T135035		0.80	9.3	430	41.0	7.2	<0.001	0.07	0.88	3.0	1.0	0.3	22.3	<0.01	0.19	3.8
T135036		0.99	25.6	510	40.8	17.9	0.001	0.06	1.26	4.5	0.8	0.4	21.3	<0.01	0.21	4.6
T135037		1.02	17.4	560	15.1	13.4	0.001	0.04	0.37	4.4	0.7	0.6	20.9	<0.01	0.10	1.5
T135038		0.49	10.1	690	9.3	6.3	<0.001	0.01	0.24	3.7	0.5	0.3	20.7	<0.01	0.03	2.6
T135039		0.16	6.3	300	9.6	14.4	<0.001	0.03	0.41	12.1	0.7	0.4	10.0	<0.01	0.10	4.1
T135040		0.69	13.1	2300	13.1	53.3	0.001	0.02	0.26	9.7	1.0	1.1	24.8	<0.01	0.14	8.0



ALS Canada Ltd.  
 2103 Dollarton Hwy  
 North Vancouver BC V7H 0A7  
 Phone: 604 984 0221 Fax: 604 984 0218 www.alsglobal.com

To: CATHRO RESOURCES  
 2560 TELFORD PLACE  
 KAMLOOPS BC V1S 0A3

Page: 2 - D  
 Total # Pages: 3 (A - D)  
 Plus Appendix Pages  
 Finalized Date: 3- AUG- 2013  
 Account: CATRES

Project: Tahte

**CERTIFICATE OF ANALYSIS WH13131710**

Sample Description	Method Analyte Units LOR	ME- MS41	ME- MS41	ME- MS41	ME- MS41	ME- MS41	ME- MS41	ME- MS41	ME- MS41
		Ti % 0.005	Ti ppm 0.02	U ppm 0.05	V ppm 1	W ppm 0.05	Y ppm 0.05	Zn ppm 2	Zr ppm 0.5
T13S001		0.055	0.11	0.52	49	0.15	6.03	43	1.4
T13S002		0.108	0.11	0.40	67	0.19	3.12	46	2.7
T13S003		0.016	0.08	0.53	26	0.12	15.95	96	1.4
T13S004		0.032	0.06	0.77	47	0.08	19.40	44	1.7
T13S005		0.012	0.08	2.02	23	0.09	46.6	38	0.6
T13S006		0.083	0.09	0.43	73	0.21	3.42	61	1.1
T13S007		0.060	0.08	0.40	58	0.31	3.96	74	0.5
T13S008		0.101	0.09	0.37	65	0.19	3.75	82	2.4
T13S009		0.053	0.09	0.42	46	0.10	5.93	82	4.2
T13S010		0.117	0.21	0.71	78	0.35	8.93	130	1.3
T13S011		0.134	0.21	0.73	64	0.27	6.16	118	1.8
T13S012		0.136	0.15	0.84	69	0.22	5.60	168	1.9
T13S013		0.136	0.13	0.61	75	0.35	4.91	85	2.5
T13S014		0.107	0.15	0.40	94	0.26	3.24	104	1.2
T13S015		0.067	0.06	0.42	39	0.14	2.69	41	1.0
T13S016		0.028	0.13	0.57	28	0.11	4.54	63	<0.5
T13S017		0.093	0.13	0.40	71	0.29	2.79	82	0.5
T13S018		0.063	0.09	0.86	42	0.23	5.49	188	1.4
T13S019		0.015	0.11	0.81	17	0.05	5.22	27	<0.5
T13S020		0.027	0.28	0.68	55	0.12	3.47	112	<0.5
T13S021		0.056	0.11	0.71	42	0.15	3.89	69	<0.5
T13S022		0.058	0.46	3.00	67	0.23	15.30	168	0.8
T13S023		0.085	0.11	0.62	55	0.19	4.16	81	0.9
T13S024		0.082	0.13	0.40	55	0.19	2.35	41	0.5
T13S025		0.103	0.11	0.52	62	0.21	4.19	80	0.5
T13S026		0.066	0.08	0.59	37	0.12	3.81	101	0.8
T13S027		0.022	0.10	0.78	55	0.07	6.66	218	1.9
T13S028		0.123	0.27	0.75	67	0.13	7.28	204	1.2
T13S029		0.045	0.10	0.55	56	0.11	5.64	154	2.5
T13S030		0.117	0.17	1.08	64	0.14	12.65	167	0.8
T13S031		0.137	0.15	1.00	66	0.13	14.10	124	1.3
T13S032		0.134	0.15	0.58	60	0.16	7.63	91	1.6
T13S033		0.120	0.12	0.61	47	0.17	6.90	103	2.4
T13S034		0.052	0.05	0.79	67	0.09	13.20	15	0.6
T13S035		0.068	0.11	0.66	37	0.11	5.29	61	1.3
T13S036		0.059	0.18	0.78	61	0.12	6.61	193	0.5
T13S037		0.040	0.12	0.43	67	0.16	5.07	67	0.8
T13S038		0.042	0.06	0.46	48	0.08	8.91	54	1.1
T13S039		0.007	0.11	0.61	29	0.07	10.50	63	0.6
T13S040		0.154	0.34	0.85	119	0.17	11.40	204	3.1

\*\*\*\*\* See Appendix Page for comments regarding this certificate \*\*\*\*\*



ALS Canada Ltd.  
 2103 Dollarton Hwy  
 North Vancouver BC V7H 0A7  
 Phone: 604 984 0221 Fax: 604 984 0218 www.alsglobal.com

To: CATHRO RESOURCES  
 2560 TELFORD PLACE  
 KAMLOOPS BC V1S 0A3

Page: 3 - A  
 Total # Pages: 3 (A - D)  
 Plus Appendix Pages  
 Finalized Date: 3- AUG- 2013  
 Account: CATRES

Project: Tahte

**CERTIFICATE OF ANALYSIS WH13131710**

Sample Description	Method Analyte Units LOR	WEI- 21	Au- TL43	ME- MS41	ME- MS41	ME- MS41	ME- MS41	ME- MS41	ME- MS41	ME- MS41	ME- MS41	ME- MS41	ME- MS41	ME- MS41	ME- MS41	ME- MS41
		Recvd Wt. kg	Au ppm	Ag ppm	Al %	As ppm	Au ppm	B ppm	Ba ppm	Be ppm	Bi ppm	Ca %	Cd ppm	Ce ppm	Co ppm	Cr ppm
T1 35041		0.49	0.002	0.05	2.20	5.8	<0.2	<10	210	0.55	0.19	0.40	0.16	36.3	11.3	31
T1 35042		0.55	0.002	0.12	1.81	6.1	<0.2	<10	140	0.38	0.23	0.41	0.14	27.8	10.3	32
T1 35043		0.56	0.002	0.05	1.82	5.1	<0.2	<10	180	0.37	0.16	0.47	0.25	24.7	10.3	26
T1 35044		0.56	0.002	0.05	1.97	5.4	<0.2	<10	150	0.46	0.18	0.40	0.14	25.4	10.6	28
T1 35045		0.60	0.001	0.05	1.14	1.8	<0.2	<10	100	0.21	0.06	0.38	0.04	23.0	5.3	9
T1 35046		0.47	0.003	0.19	1.44	6.8	<0.2	<10	140	0.28	0.22	0.32	0.16	17.60	10.3	21
T1 35047		0.59	0.007	0.33	2.41	10.4	<0.2	<10	140	0.55	0.21	0.11	1.96	32.1	15.3	37
T1 35048		0.56	0.022	1.08	2.02	14.6	<0.2	<10	320	2.04	0.51	1.28	2.07	92.2	37.1	144
T1 35049		0.63	0.005	0.34	2.43	9.8	<0.2	<10	120	0.58	0.25	0.24	0.47	25.1	12.1	38
T1 35050		0.70	0.004	0.26	1.39	8.5	<0.2	<10	110	0.38	0.30	0.12	0.12	24.0	4.9	21
T1 35051		0.71	0.023	0.70	0.76	13.0	<0.2	<10	90	0.23	0.38	0.13	0.16	18.50	3.8	17
T1 35052		0.82	0.012	0.48	1.80	15.3	<0.2	<10	170	0.66	0.30	0.17	0.96	31.5	10.0	27
T1 35053		0.71	0.012	0.52	1.61	11.6	<0.2	<10	140	0.64	0.24	0.25	0.83	26.8	9.1	28
T1 35054		0.72	0.005	0.29	1.10	4.2	<0.2	<10	150	0.22	0.13	0.21	0.45	15.15	3.0	19
T1 35055		0.85	0.005	0.20	1.54	9.5	<0.2	<10	180	0.43	0.20	0.35	0.29	25.1	8.1	29
T1 35056		0.87	0.010	0.28	1.80	11.2	<0.2	<10	220	0.49	0.27	0.32	0.27	28.2	7.0	27
T1 35057		0.60	0.011	0.35	1.27	13.8	<0.2	<10	100	0.27	0.48	0.11	0.14	20.2	4.3	20
T1 35058		0.79	0.016	0.31	1.84	19.9	<0.2	<10	220	0.30	0.40	0.23	0.25	21.1	7.5	30
T1 35059		0.86	0.016	0.37	2.20	6.3	<0.2	<10	280	0.38	0.31	0.16	0.21	35.0	4.4	22
T1 35060		0.76	0.014	0.31	1.77	12.0	<0.2	<10	300	0.41	0.63	0.39	0.19	61.6	7.4	46
T1 35061		0.62	0.005	0.95	3.05	10.8	<0.2	<10	130	0.65	0.26	0.20	0.93	28.1	13.9	31
T1 35062		0.52	0.003	0.13	2.48	9.8	<0.2	<10	120	0.58	0.23	0.16	0.31	32.8	14.9	30
T1 35063		0.55	0.001	0.29	1.93	6.0	<0.2	<10	100	0.35	0.08	0.22	0.34	22.8	8.5	18
T1 35064		0.67	0.001	0.14	2.63	5.3	<0.2	<10	120	0.81	0.19	0.17	0.26	35.7	14.9	27
T1 35065		0.64	0.002	0.07	2.65	9.3	<0.2	<10	170	0.88	0.15	0.14	0.21	44.1	14.2	30
T1 35066		0.50	0.001	0.12	1.20	4.0	<0.2	<10	70	0.25	0.11	0.18	0.22	17.20	4.8	16
T1 35067		0.60	0.002	0.05	1.51	6.4	<0.2	<10	310	0.24	0.08	0.58	0.14	12.75	6.9	17
T1 35068		0.44	0.005	0.57	0.97	2.2	<0.2	<10	120	0.36	0.06	0.38	0.43	35.8	5.9	7
T1 35069		0.74	0.009	0.34	2.49	8.0	<0.2	<10	130	0.51	0.18	0.30	0.51	29.9	10.6	38
T1 35070		0.35	0.015	0.83	1.26	4.0	<0.2	<10	230	0.40	0.13	0.48	0.99	66.3	16.0	20
T1 35071		0.73	0.024	0.36	2.13	5.7	<0.2	<10	160	0.64	0.26	0.25	0.35	35.8	9.4	27
T1 35072		0.38	0.002	0.11	0.27	0.6	<0.2	<10	40	0.09	0.03	0.14	0.38	7.72	2.2	3
T1 35073		0.57	0.016	0.14	1.48	2.8	<0.2	<10	160	0.53	0.11	0.26	0.82	39.9	7.5	10



ALS Canada Ltd.  
 2103 Dollarton Hwy  
 North Vancouver BC V7H 0A7  
 Phone: 604 984 0221 Fax: 604 984 0218 www.alsglobal.com

To: CATHRO RESOURCES  
 2560 TELFORD PLACE  
 KAMLOOPS BC V1S 0A3

Page: 3 - B  
 Total # Pages: 3 (A - D)  
 Plus Appendix Pages  
 Finalized Date: 3- AUG- 2013  
 Account: CATRES

Project: Tahte

**CERTIFICATE OF ANALYSIS WH13131710**

Sample Description	Method Analyte Units LOR	ME- MS41	ME- MS41	ME- MS41	ME- MS41	ME- MS41	ME- MS41	ME- MS41	ME- MS41	ME- MS41	ME- MS41	ME- MS41	ME- MS41	ME- MS41	ME- MS41	ME- MS41
		Cs ppm	Cu ppm	Fe %	Ga ppm	Ge ppm	Hf ppm	Hg ppm	In ppm	K %	La ppm	Li ppm	Mg %	Mn ppm	Mo ppm	Na %
T1 35041		1.31	21.6	3.63	8.31	0.07	0.05	0.02	0.035	0.23	17.8	20.6	0.93	574	1.73	0.02
T1 35042		1.24	21.3	3.36	8.88	0.05	0.02	0.02	0.031	0.18	15.6	10.3	0.73	423	4.52	0.02
T1 35043		1.32	15.3	3.63	7.61	0.07	0.02	0.02	0.029	0.12	14.6	11.8	0.88	587	1.86	0.02
T1 35044		1.45	14.4	3.65	7.28	0.07	0.06	0.01	0.036	0.19	12.3	15.3	0.83	462	2.43	0.02
T1 35045		0.32	6.6	2.63	3.82	<0.05	0.03	0.01	0.019	0.04	12.5	5.5	0.36	228	0.79	0.01
T1 35046		0.57	14.4	3.09	5.54	<0.05	0.02	0.03	0.030	0.06	9.8	8.7	0.51	691	1.98	0.02
T1 35047		1.35	24.6	4.00	9.16	0.05	0.02	0.03	0.066	0.21	13.7	15.5	0.63	990	2.20	0.02
T1 35048		1.83	50.3	7.29	8.23	0.18	0.06	0.15	0.155	0.27	54.7	3.6	0.72	2680	1.17	0.03
T1 35049		1.07	24.6	3.20	6.43	<0.05	0.04	0.04	0.036	0.13	11.8	15.5	0.64	404	4.53	0.03
T1 35050		0.78	19.3	2.27	4.92	0.05	0.02	0.04	0.028	0.07	13.4	7.8	0.25	149	8.65	0.02
T1 35051		0.68	19.6	1.84	2.66	<0.05	0.04	0.03	0.048	0.08	11.1	4.0	0.21	219	16.96	0.02
T1 35052		0.87	28.9	2.66	5.08	0.05	0.05	0.03	0.041	0.09	16.6	9.6	0.38	693	1.91	0.02
T1 35053		0.80	38.3	2.29	4.44	0.05	0.04	0.03	0.038	0.07	14.9	8.4	0.39	755	1.29	0.02
T1 35054		0.57	8.6	1.21	4.08	<0.05	<0.02	0.05	0.019	0.03	8.1	5.2	0.23	131	0.85	0.01
T1 35055		0.67	25.0	2.47	4.71	0.06	0.15	0.02	0.032	0.09	13.3	8.6	0.41	368	3.49	0.02
T1 35056		0.69	26.0	2.56	5.44	0.07	0.30	0.04	0.041	0.10	15.4	7.8	0.32	337	5.26	0.02
T1 35057		0.69	28.8	2.17	4.09	<0.05	0.02	0.04	0.031	0.08	12.1	5.7	0.29	197	31.8	0.02
T1 35058		1.27	24.7	3.47	6.64	0.05	0.02	0.07	0.029	0.11	11.8	6.8	0.38	322	51.6	0.02
T1 35059		0.89	22.2	4.37	7.64	0.06	0.02	0.06	0.024	0.17	19.5	7.6	0.77	221	6.29	0.03
T1 35060		1.07	34.5	4.99	7.43	0.10	0.02	0.05	0.045	0.69	36.7	5.5	0.68	415	4.57	0.03
T1 35061		1.33	23.6	3.93	9.41	0.05	0.02	0.05	0.042	0.10	12.2	14.6	0.97	742	1.68	0.02
T1 35062		1.39	22.6	3.96	7.35	0.05	0.02	0.03	0.041	0.20	13.8	12.7	0.79	753	1.37	0.02
T1 35063		0.69	11.8	3.19	6.35	<0.05	<0.02	0.02	0.028	0.09	10.3	13.1	0.66	735	1.08	0.02
T1 35064		2.23	28.1	4.61	10.05	0.05	<0.02	0.03	0.044	0.31	16.5	10.9	0.87	600	3.39	0.02
T1 35065		1.31	24.0	3.50	7.40	0.05	0.05	0.03	0.042	0.15	14.7	14.5	0.68	618	1.21	0.02
T1 35066		0.77	18.4	2.13	6.03	<0.05	<0.02	0.03	0.016	0.04	9.7	5.4	0.30	166	1.13	0.02
T1 35067		0.61	9.4	2.56	6.05	<0.05	0.03	0.01	0.019	0.10	6.9	11.6	0.74	522	0.93	0.02
T1 35068		0.37	13.7	1.49	3.47	0.07	<0.02	0.05	0.012	0.03	28.9	2.4	0.14	1860	0.91	0.04
T1 35069		1.09	23.2	3.48	7.64	<0.05	0.05	0.03	0.036	0.11	14.0	13.2	0.72	499	1.59	0.02
T1 35070		0.52	36.8	2.29	4.37	0.07	0.02	0.13	0.020	0.07	33.7	4.0	0.25	2420	1.57	0.03
T1 35071		1.12	65.7	3.23	6.54	0.07	0.02	0.02	0.051	0.11	20.3	7.9	0.61	475	6.97	0.02
T1 35072		0.11	9.8	0.79	1.80	<0.05	<0.02	0.02	0.006	0.02	3.0	0.6	0.06	150	0.24	0.04
T1 35073		0.57	41.6	2.58	6.04	0.05	0.03	0.01	0.031	0.09	21.9	6.9	0.72	1100	2.78	0.01

\*\*\*\*\* See Appendix Page for comments regarding this certificate \*\*\*\*\*



ALS Canada Ltd.  
 2103 Dollarton Hwy  
 North Vancouver BC V7H 0A7  
 Phone: 604 984 0221 Fax: 604 984 0218 www.alsglobal.com

To: CATHRO RESOURCES  
 2560 TELFORD PLACE  
 KAMLOOPS BC V1S 0A3

Page: 3 - C  
 Total # Pages: 3 (A - D)  
 Plus Appendix Pages  
 Finalized Date: 3- AUG- 2013  
 Account: CATRES

Project: Tahte

**CERTIFICATE OF ANALYSIS WH13131710**

Sample Description	Method Analyte Units LOR	ME- MS41	ME- MS41	ME- MS41	ME- MS41	ME- MS41	ME- MS41	ME- MS41	ME- MS41	ME- MS41	ME- MS41	ME- MS41	ME- MS41	ME- MS41	ME- MS41	ME- MS41
		Nb ppm	Ni ppm	P ppm	Pb ppm	Rb ppm	Re ppm	S %	Sb ppm	Sc ppm	Se ppm	Sn ppm	Sr ppm	Ta ppm	Te ppm	Th ppm
T13S041		1.40	14.9	710	9.2	30.1	<0.001	0.02	0.26	6.9	0.6	0.7	35.0	<0.01	0.06	3.8
T13S042		1.40	15.1	400	10.5	28.6	<0.001	0.03	0.28	6.5	0.5	0.9	25.5	<0.01	0.04	1.9
T13S043		1.29	12.3	400	13.6	18.9	<0.001	0.04	0.22	6.0	0.4	0.7	27.7	<0.01	0.05	2.2
T13S044		1.30	15.4	410	9.6	29.9	<0.001	0.02	0.27	6.5	0.4	0.8	26.1	<0.01	0.06	3.8
T13S045		0.40	4.4	1050	6.1	4.7	<0.001	0.01	0.11	2.1	0.2	0.3	17.8	<0.01	0.01	1.4
T13S046		0.88	10.1	760	23.0	8.5	<0.001	0.04	0.31	3.6	0.6	0.4	19.8	<0.01	0.08	2.1
T13S047		1.49	21.8	390	40.3	26.8	<0.001	0.04	0.44	5.6	0.6	0.7	15.4	<0.01	0.08	2.6
T13S048		0.55	66.9	3440	44.7	26.3	<0.001	0.01	0.82	27.4	2.1	1.5	61.5	<0.01	0.77	7.9
T13S049		1.63	19.8	610	10.5	11.5	<0.001	0.06	0.41	5.0	0.7	0.6	25.7	0.01	0.08	2.9
T13S050		1.06	9.9	250	13.3	6.1	<0.001	0.08	0.48	2.7	0.6	0.4	20.7	<0.01	0.11	2.6
T13S051		0.68	6.4	220	93.1	5.0	0.001	0.10	0.83	2.6	0.5	0.3	20.0	<0.01	0.19	3.0
T13S052		1.09	16.4	400	49.0	7.7	<0.001	0.06	0.86	4.5	1.0	0.5	19.2	<0.01	0.23	3.3
T13S053		0.86	13.3	430	33.3	8.0	<0.001	0.01	0.64	4.9	0.6	0.4	21.5	<0.01	0.18	3.0
T13S054		0.45	6.5	530	18.7	4.0	<0.001	0.03	0.27	1.6	0.3	0.3	16.9	<0.01	0.09	0.2
T13S055		0.55	16.6	640	15.5	8.3	0.001	0.01	0.43	6.0	0.5	0.4	28.7	<0.01	0.12	3.5
T13S056		0.31	14.2	620	22.3	9.5	<0.001	0.01	0.50	7.1	0.5	0.5	33.6	<0.01	0.16	5.1
T13S057		0.88	8.2	250	30.7	7.2	<0.001	0.05	1.13	2.6	0.8	0.3	18.1	<0.01	0.34	3.5
T13S058		1.05	12.6	720	31.9	11.5	<0.001	0.08	0.65	3.5	1.0	0.5	39.2	<0.01	0.30	1.6
T13S059		0.59	8.3	820	13.6	15.1	<0.001	0.11	0.37	4.9	2.0	0.3	89.1	<0.01	0.20	3.5
T13S060		1.54	19.9	810	18.3	47.6	<0.001	0.56	0.30	8.3	1.1	0.7	48.1	<0.01	0.47	10.8
T13S061		1.33	19.4	520	30.0	15.0	<0.001	0.05	0.50	6.0	0.6	0.8	18.4	<0.01	0.18	2.4
T13S062		1.29	18.7	430	21.6	24.2	<0.001	0.04	0.51	5.8	0.5	0.7	14.1	<0.01	0.22	3.2
T13S063		0.66	8.7	470	14.2	7.9	<0.001	0.02	0.23	3.2	0.2	0.4	14.7	<0.01	0.03	1.5
T13S064		1.20	15.7	480	10.8	45.1	<0.001	0.03	0.24	7.8	0.6	1.3	11.0	<0.01	0.10	3.2
T13S065		1.41	23.0	370	14.2	19.1	<0.001	0.02	0.37	5.9	0.5	0.6	11.7	<0.01	0.06	4.5
T13S066		0.81	8.1	360	6.7	7.7	<0.001	0.03	0.27	2.0	0.4	0.5	13.4	<0.01	0.04	0.4
T13S067		0.97	7.7	370	14.2	14.2	<0.001	0.02	0.20	3.6	0.3	0.4	23.7	<0.01	0.03	1.7
T13S068		0.31	4.3	750	7.0	4.0	<0.001	0.05	0.14	1.5	0.9	0.2	21.7	<0.01	0.02	0.2
T13S069		1.76	20.3	620	14.1	17.1	<0.001	0.02	0.32	6.3	0.6	0.7	21.1	<0.01	0.10	5.6
T13S070		0.66	12.0	1020	7.2	8.3	<0.001	0.16	0.21	4.7	1.4	0.3	32.6	<0.01	0.09	0.9
T13S071		1.17	11.8	590	15.9	14.4	<0.001	0.04	0.41	6.0	0.7	0.7	30.4	<0.01	0.16	3.8
T13S072		0.17	2.0	520	1.3	1.1	<0.001	0.02	0.06	0.5	<0.2	<0.2	13.5	<0.01	0.02	<0.2
T13S073		0.96	6.0	850	10.8	6.6	<0.001	0.02	0.17	3.8	0.4	0.3	21.0	<0.01	0.10	3.4



ALS Canada Ltd.  
 2103 Dollarton Hwy  
 North Vancouver BC V7H 0A7  
 Phone: 604 984 0221 Fax: 604 984 0218 www.alsglobal.com

To: CATHRO RESOURCES  
 2560 TELFORD PLACE  
 KAMLOOPS BC V1S 0A3

Page: 3 - D  
 Total # Pages: 3 (A - D)  
 Plus Appendix Pages  
 Finalized Date: 3- AUG- 2013  
 Account: CATRES

Project: Tahte

**CERTIFICATE OF ANALYSIS WH13131710**

Sample Description	Method Analyte Units LOR	ME- MS41	ME- MS41	ME- MS41	ME- MS41	ME- MS41	ME- MS41	ME- MS41	
		Ti % 0.005	Ti ppm 0.02	U ppm 0.05	V ppm 1	W ppm 0.05	Y ppm 0.05	Zn ppm 2	Zr ppm 0.5
T135041		0.159	0.22	0.63	85	0.17	8.51	87	1.6
T135042		0.130	0.15	0.67	78	0.16	6.51	60	0.7
T135043		0.126	0.13	0.57	65	0.17	6.78	108	0.9
T135044		0.129	0.17	0.61	65	0.20	5.96	87	1.7
T135045		0.014	0.05	0.32	47	0.07	4.58	42	1.1
T135046		0.056	0.09	0.56	50	0.46	4.37	83	0.8
T135047		0.111	0.20	0.64	76	0.17	5.12	261	0.8
T135048		0.061	0.24	1.18	130	0.07	37.9	387	1.2
T135049		0.120	0.13	0.60	67	0.23	4.87	72	1.4
T135050		0.077	0.09	0.77	46	0.16	3.98	33	0.6
T135051		0.064	0.08	0.73	32	0.11	4.00	43	1.7
T135052		0.090	0.12	0.95	53	0.16	10.30	130	2.0
T135053		0.089	0.11	1.31	48	0.15	10.00	156	1.4
T135054		0.046	0.10	0.44	32	0.14	3.24	72	<0.5
T135055		0.099	0.11	0.67	52	0.14	9.87	62	6.0
T135056		0.116	0.11	1.06	54	0.13	9.88	58	12.1
T135057		0.068	0.09	0.71	40	0.12	3.24	43	0.7
T135058		0.073	0.13	0.96	69	0.25	4.37	58	0.9
T135059		0.043	0.21	0.79	53	0.06	4.22	55	1.4
T135060		0.117	0.42	1.14	59	0.12	7.43	109	1.3
T135061		0.116	0.16	0.76	78	0.75	6.42	150	0.7
T135062		0.110	0.18	0.66	68	0.24	6.82	93	0.7
T135063		0.031	0.07	0.33	55	0.11	4.44	80	0.5
T135064		0.124	0.25	1.11	75	0.10	9.25	88	0.5
T135065		0.098	0.15	0.78	63	0.19	5.97	70	1.9
T135066		0.072	0.07	0.49	55	0.12	3.76	35	<0.5
T135067		0.060	0.07	0.34	48	0.10	4.24	74	1.2
T135068		0.040	0.05	0.72	38	0.07	21.1	27	<0.5
T135069		0.121	0.14	0.80	71	0.21	7.60	112	1.7
T135070		0.047	0.14	1.74	37	0.12	14.20	43	<0.5
T135071		0.076	0.13	1.09	60	0.11	8.39	100	0.6
T135072		0.038	0.02	0.29	26	<0.05	1.70	17	<0.5
T135073		0.053	0.07	0.75	42	<0.05	10.35	209	1.3

\*\*\*\*\* See Appendix Page for comments regarding this certificate \*\*\*\*\*



ALS Canada Ltd.  
 2103 Dollarton Hwy  
 North Vancouver BC V7H 0A7  
 Phone: 604 984 0221 Fax: 604 984 0218 www.alsglobal.com

To: CATHRO RESOURCES  
 2560 TELFORD PLACE  
 KAMLOOPS BC V1S 0A3

Page: Appendix 1  
 Total # Appendix Pages: 1  
 Finalized Date: 3- AUG- 2013  
 Account: CATRES

Project: Tahte

**CERTIFICATE OF ANALYSIS WH13131710**

<b>CERTIFICATE COMMENTS</b>	
Applies to Method:	<b>ANALYTICAL COMMENTS</b>
	Gold determinations by this method are semi- quantitative due to the small sample weight used (0.5g). ME- MS41
Applies to Method:	<b>LABORATORY ADDRESSES</b>
	Processed at ALS Whitehorse located at 78 Mt. Sima Rd, Whitehorse, YT, Canada. LOG- 22 SCR- 41 WEI- 21
Applies to Method:	Processed at ALS Vancouver located at 2103 Dollarton Hwy, North Vancouver, BC, Canada. Au- TL43 ME- MS41

## Appendix 3

Report on Induced Polarization Surveying by Peter E. Walcott and Associates

**A REPORT**

**ON**

**INDUCED POLARIZATION SURVEYING**

**TAHTE PROPERTY  
CARMACKS AREA, YUKON  
WHITEHORSE M.D.  
58.317° N, 129.737° W  
NTS 115H/15**

**Claims Surveyed: 90722,90724,90726,90728,90730,90732,90734,  
90751-90766**

**Survey Dates: July 13<sup>th</sup> – 21<sup>st</sup>, 2013**

**FOR**

**CATHRO RESOURCES CORPORATION  
Kamloops, British Columbia**

**BY**

**PETER E. WALCOTT & ASSOCIATES LIMITED  
Coquitlam, British Columbia**

**JANUARY 2014**

## **TABLE OF CONTENTS**

	<b><u>Page</u></b>
INTRODUCTION.....	3
PROPERTY, LOCATION AND ACCESS.....	4
PREVIOUS WORK .....	7
PURPOSE.....	8
SURVEY SPECIFICATIONS .....	9
DISCUSSION OF RESULTS.....	11
SUMMARY, CONCLUSIONS & RECOMMENDATIONS.....	17

## **APPENDIX I**

Cost of Survey  
 Personnel Employed on Survey  
 Certification

## **ACCOMPANYING MAPS**

Claim and Line Location Map	Scale 1:5,000
Line Location Map with Airborne Magnetics	Scale 1:5,000
Pseudo-sections – 700, 1200 & 2700N	Scale 1:10,000
2D Inverted Sections - 700, 1200 & 2700N	Scale 1:10,000
Plan Maps of Historic IP, Resistivity, and Magnetics	Scale 1:5,000

## **INTRODUCTION.**

Between July 13<sup>th</sup> and 21<sup>st</sup> , 2013, Peter E. Walcott & Associates Limited undertook 9.1 kilometres of induced polarization (I.P.) traversing over part of the Tahte Property, located in the Carmacks area of the Yukon, for Cathro Resources Corporation.

The surveying was carried out over three 060 orientated survey lines, established by Cathro Resources Corporation personnel prior to the arrival of the geophysical crew.

Measurements – first to sixth separation- of apparent chargeability – the I.P. response parameter – and resistivity were made on the line using the pole-dipole technique with a 100 metre dipole.

In addition the elevation and horizontal locations of the line stations were measured using a WAAS equipped Garmin GPS unit.

The I.P. data is presented as individual pseudo-sections at a scale of 1:10,000.

## **PROPERTY LOCATION AND ACCESS**

The Tahte property is located some 50 kilometres south west of the community of Carmacks, Yukon.

Access to the property was gained via helicopter from Carmacks, Yukon to a fly camp located on the property proximal to the survey grid, where the crew was housed for the duration of the survey.

**PROPERTY LOCATION AND ACCESS con't**

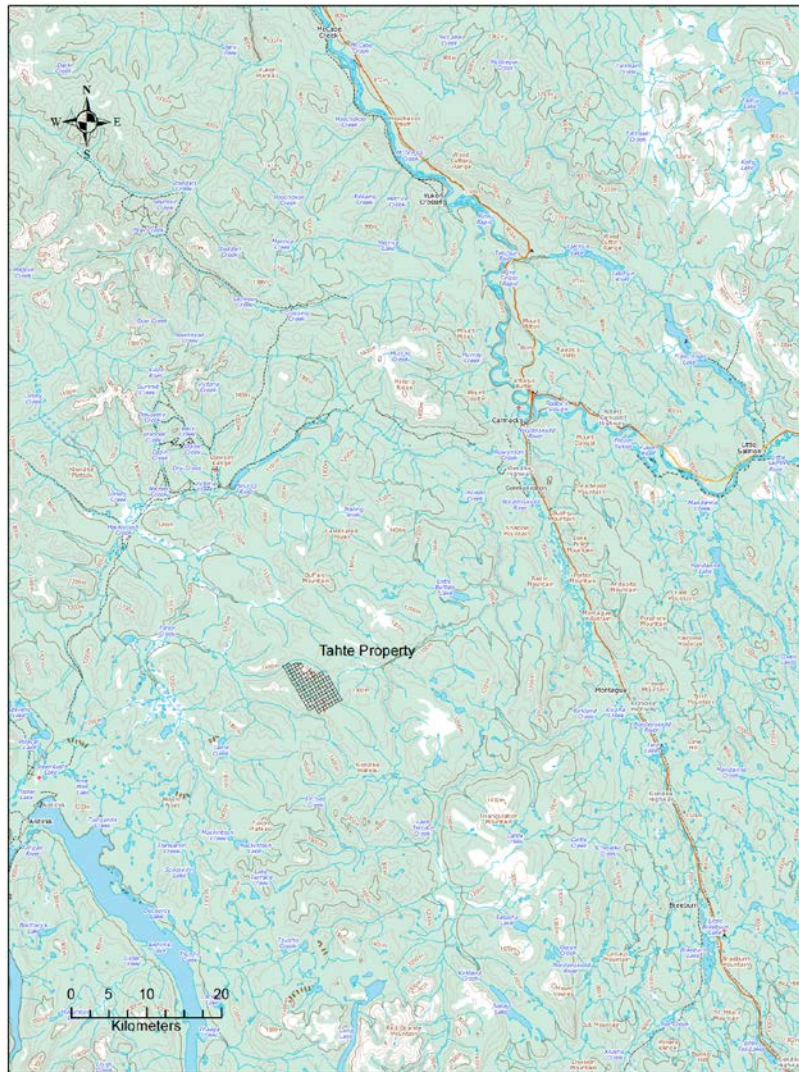

*Property Location Map*

**PROPERTY LOCATION AND ACCESS con't**

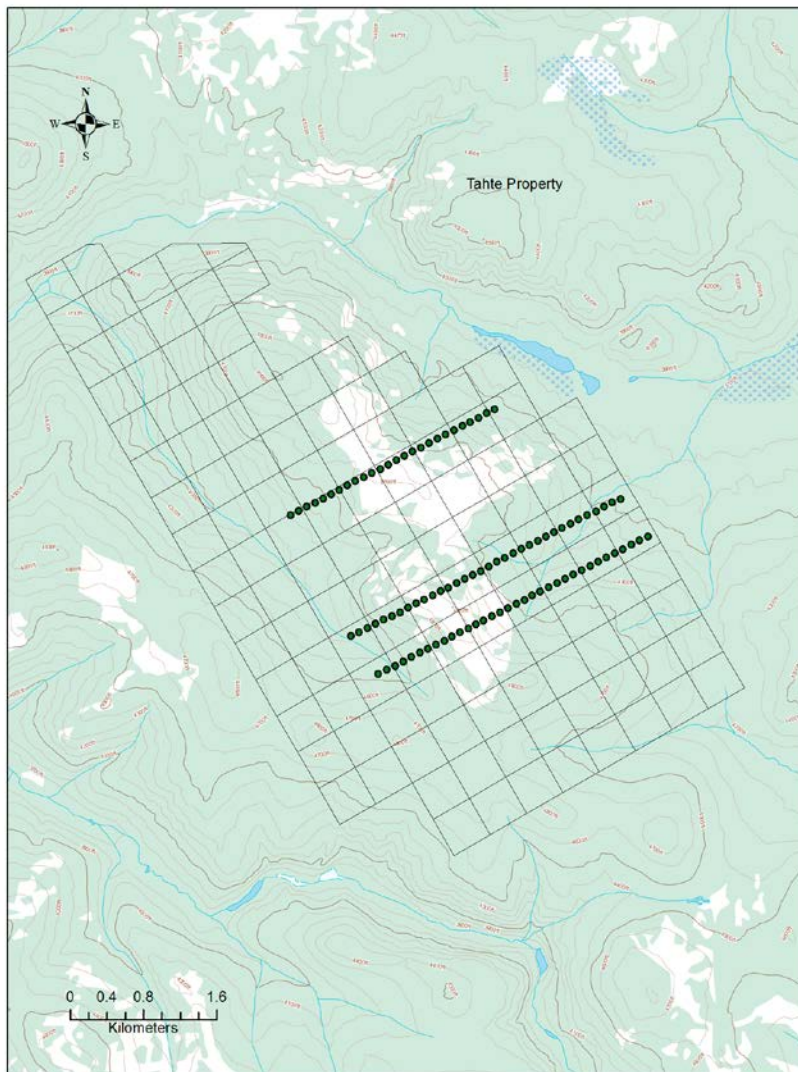

*Claim Location Map*

## **PREVIOUS WORK**

Historic work on the property dates back to the late 1970's when the property was acquired by Noranda Exploration Company. Noranda conducted a number of work campaigns, including geological mapping, induced polarization, magnetics and drilling.

No other recorded exploration work is apparent until 2010, when Cathro Resources Corp, undertook a prospecting, sampling and re-logging of historic core.

For further information the reader is referred to the respective reports on the aforementioned programmes.

**PURPOSE.**

The purpose of the survey was to augment the historic induced polarization coverage and increase the depth of investigation over an area where favorable geology and geochemical responses indicate the presence of an Au-Cu-Mo porphyry system.

## **SURVEY SPECIFICATIONS.**

### *The Induced Polarization Survey.*

The induced polarization (I.P.) survey was conducted using a pulse type system, the principal components of which were manufactured by Instrumentation GDD of St. Foy, Quebec.

The system consists basically of three units, a receiver (GDD), transmitter (GDD) and a motor generator. The transmitter, which provides a maximum of 5 kw d.c. to the ground, obtains its power from a 9 kw 60 c.p.s. single phase alternator driven by a Honda 14 h.p. gasoline engine. The cycling rate of the transmitter is 2 seconds “current-on” and 2 seconds “current-off” with the pulses reversing continuously in polarity. The data recorded in the field consists of careful measurements of the current (I) in amperes flowing through the current electrodes  $C_1$  and  $C_2$ , the primary voltages (V) appearing between any two sequential potential electrodes,  $P_1$  through  $P_{n+1}$ , during the “current-on” part of the cycle, and the apparent chargeability, ( $M_a$ ) presented as a direct readout in millivolts per volt using a 200 millisecond delay and a 1000 millisecond sample window by the receiver, a digital receiver controlled by a micro-processor – the sample window is actually the total of twenty individual windows of 50 millisecond widths.

The apparent resistivity ( $\rho_a$ ) in ohm metres is proportional to the ratio of the primary voltage and the measured current, the proportionality factor depending on the geometry of the array used. The chargeability and resistivity are called apparent as they are values which that portion of the earth sampled would have if it were homogeneous. As the earth sampled is usually inhomogeneous the calculated apparent chargeability and resistivity are functions of the actual chargeability and resistivity of the rocks.

The survey was carried out using the “pole-dipole” method of surveying. In this method the current electrode,  $C_1$ , and the potential electrodes,  $P_1$  through  $P_{n+1}$ , are moved in unison along the survey lines at a spacing of “a” (the dipole) apart, while the second current electrode,  $C_2$ , is kept constant at “infinity”. The distance, “na” between  $C_1$  and the nearest potential electrode generally controls the depth to be explored by the particular separation, “n”, traverse.

## **SURVEY SPECIFICATIONS cont'd**

On this survey 100 m dipoles were employed and first to six separation readings were obtained. In all some 9.1 kilometres of I.P. traversing were completed on three lines.

### *Horizontal control.*

The horizontal position of the stations were recorded using an WAAS equipped Garmin C60 handheld GPS receiver.

### *Data Presentation.*

The I.P. data are presented as an individual pseudo-section plot of apparent chargeability and resistivity at a scale of 1:10,000. Plots of the 21 point moving filter – illustrated on the pseudo section – for the above are also displayed in the top window to better show the location of the anomalous zones.

Two dimensional smooth model inversion of the resistivity and chargeability was carried out using the Geotomo RES2DINV Algorithm, an algorithm developed by Loke et-al. This algorithm uses a 2-D finite element method and incorporates topography in modeling resistivity and I.P. data. Nearly uniform starting models are generated by running broad moving-average filters over the respective lines of data. Model resistivity and chargeability properties are then adjusted iteratively until the calculated data values match the observed as closely as possible, given constraints which keep the model section smooth. The smooth chargeability and resistivity models were then imported into Geosoft format for presentation at the same scale of 1:10,000 on the topographic profile. A slight discrepancy can be observed between the measured and modeled plots as the former are processed in Geosoft which assumes horizontal distances for the station separation.

## DISCUSSION OF RESULTS.

Line 700N shows two intense chargeability features. The western feature centered at 2700E is associated with a broad chargeability zone extending to depth, within a low to moderate intensity resistivity feature. This feature is also coincident with a magnetic high readily seen in the historic magnetic data, along with a copper and molybdenum soil geochemistry anomaly. Two shallow historic drill holes – TAH-01 and TAH-03, were also drilled proximal to the anomaly at 2800E and 2975E respectively with both returning highly anomalous values in copper and molybdenum.

To the east of the aforementioned anomaly, second similar intensity anomaly is also readily observed centered at 3100E. The anomaly is directly associated with a low resistivity zone and is proximal to a copper and gold soil geochemistry anomaly.

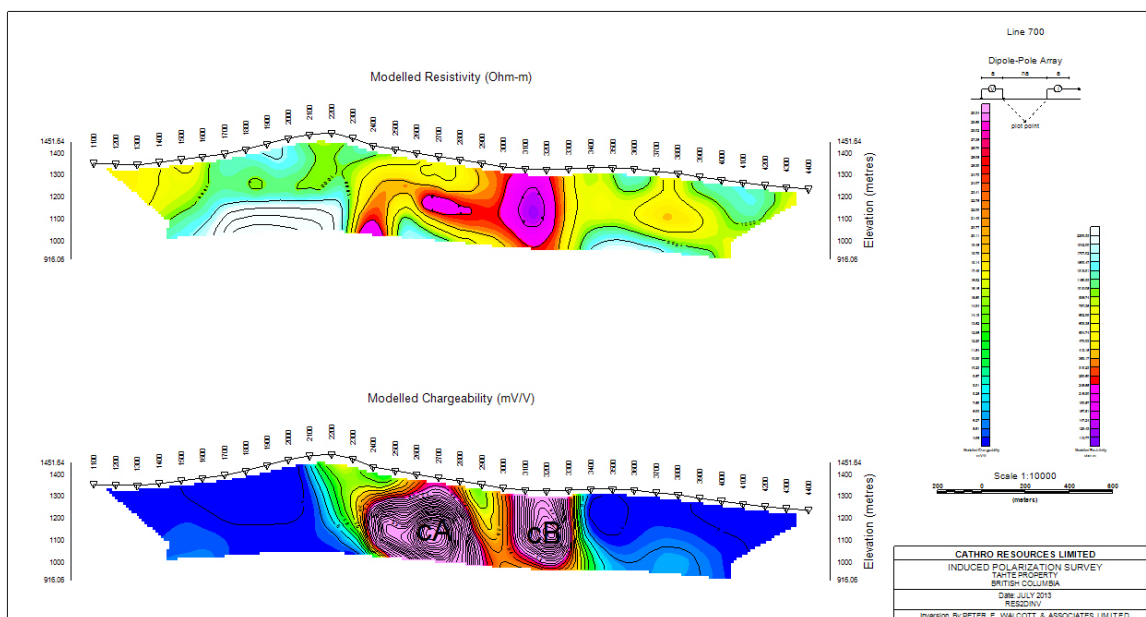

Line 700 N – 2D Inversion

## DISCUSSION OF RESULTS con't.

Line 1200N shows broad intense chargeability anomaly centered at 2950E. This anomaly appears to extend to depth, and contained within low to moderate intensity resistivity features. A coincident copper, molybdenum, and gold anomaly flanks the eastern portion of the anomaly between 3000E and 3500E

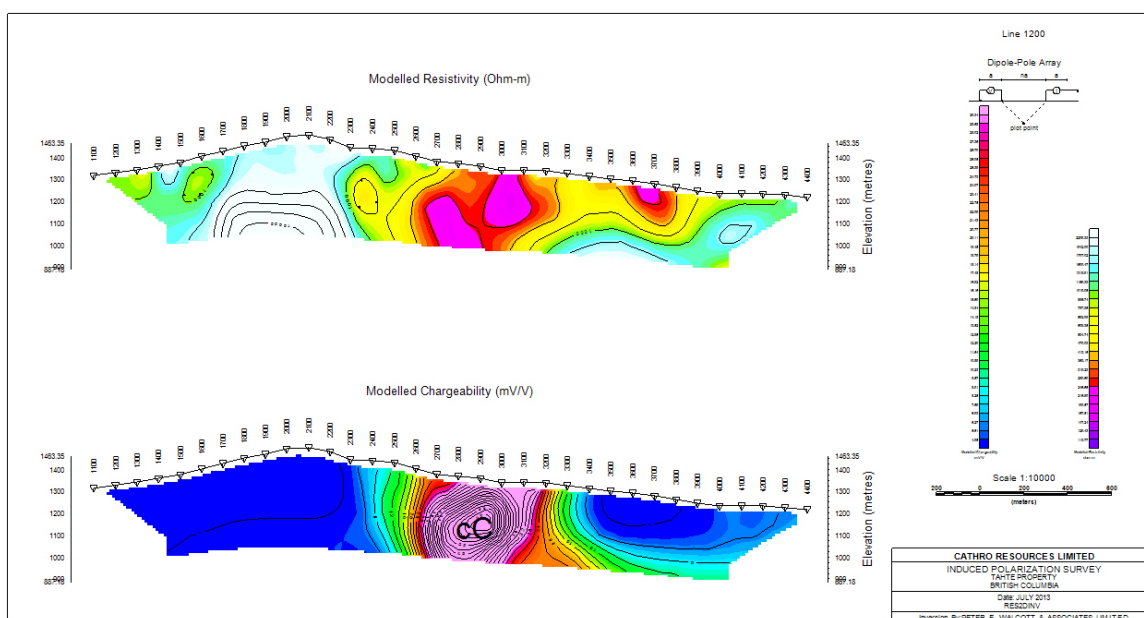

Line 1200 N – 2D Inversion

Lines 700N and 1200N show excellent correlation with the historic IP conducted by Noranda in the late 1970's.

Anomalies cB and cC appear to be associated with a lower resistivity feature. It demonstrates an arcuate shape with the nose proximal to anomaly cC. This feature potentially wraps around to trend southwards and may be part of/associated with the low resistivity feature observed on the western flank on Anomaly cA.

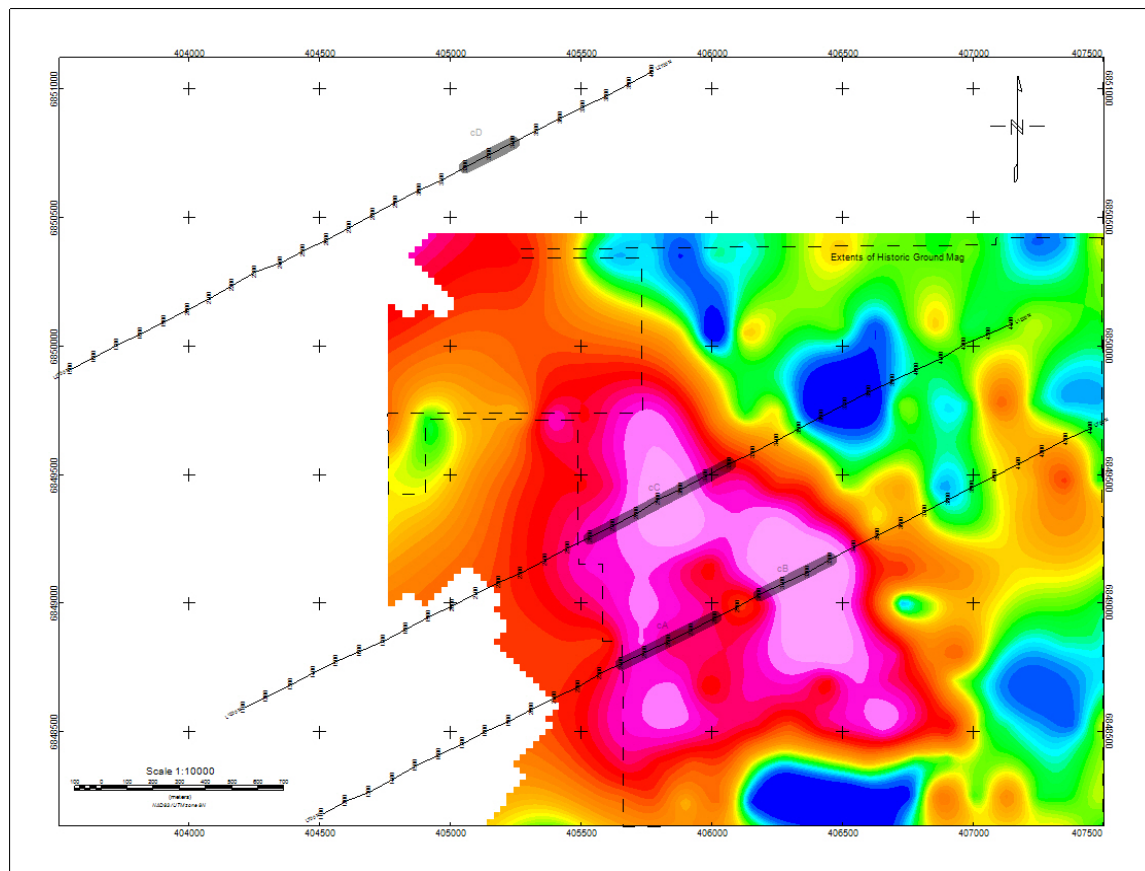
**DISCUSSION OF RESULTS con't.**

2013 IP Anomalies on Historic IP

## DISCUSSION OF RESULTS con't.

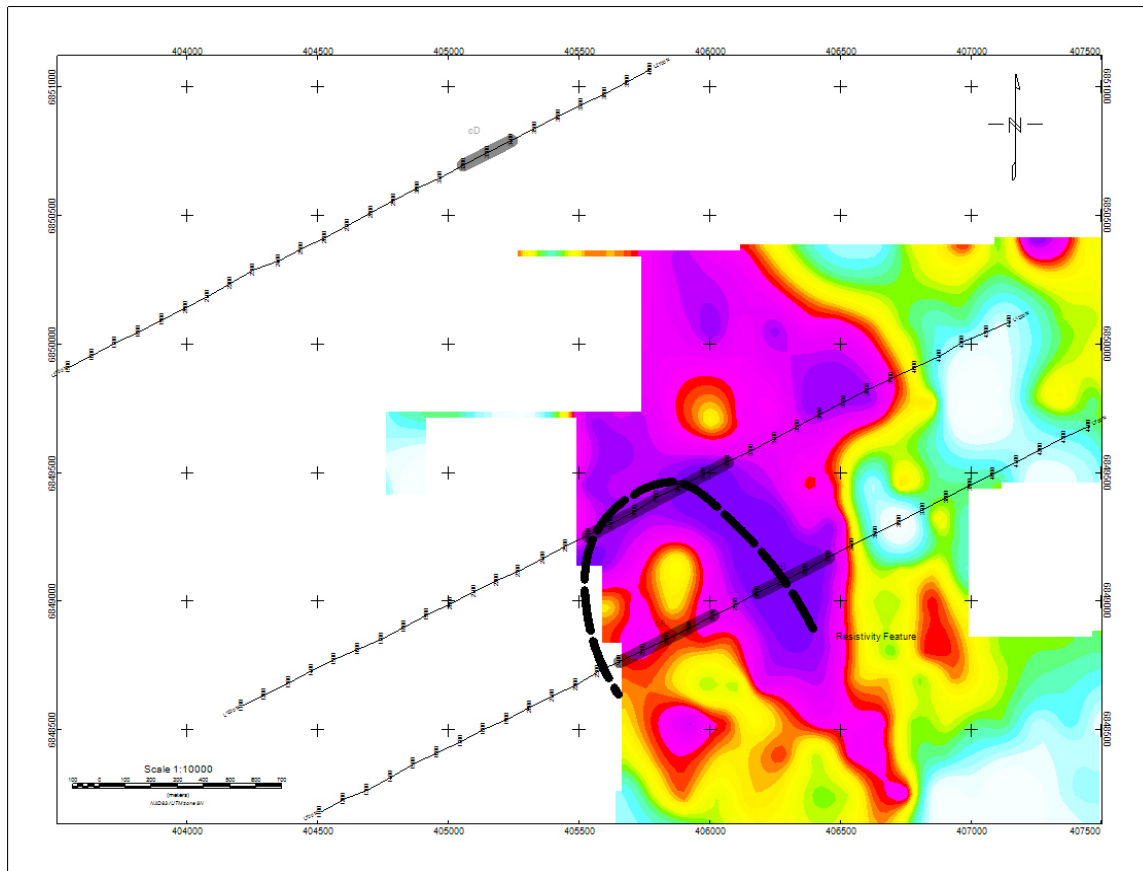

2013 IP Anomalies on Historic Resistivity

Line 2700N – shows a weak chargeability – Anomaly cD - feature at depth, on the eastern flank of a sharp resistivity contact. This feature appears to be associated with a resistivity low.

## DISCUSSION OF RESULTS con't.

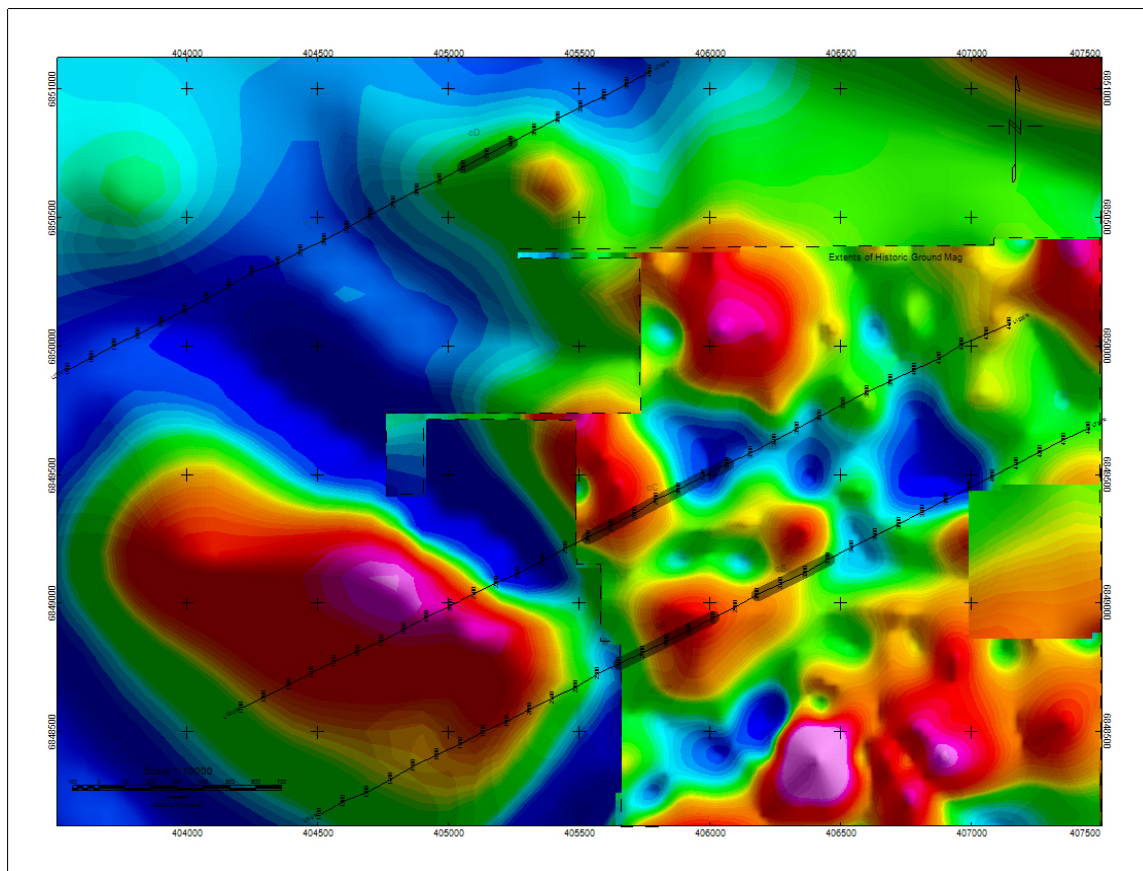

Historic Magnetics overlaid on Regional Airborne.

**DISCUSSION OF RESULTS con't.**

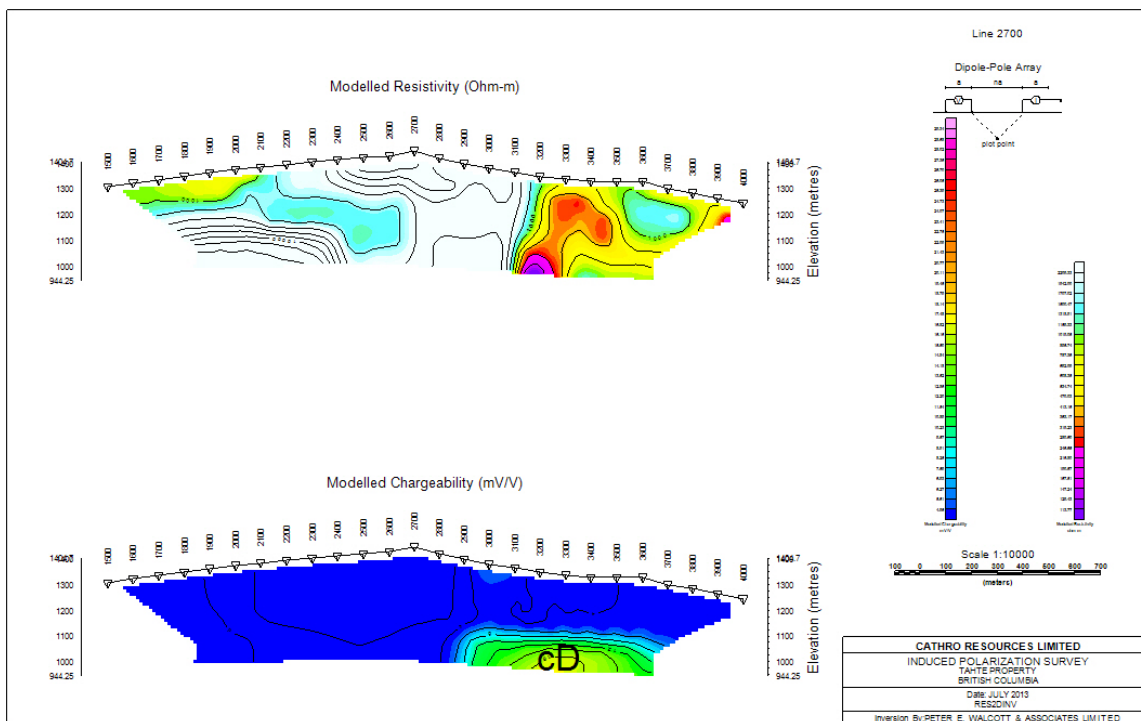

Line 2700 N – 2D Inversion

## **SUMMARY, CONCLUSIONS & RECOMMENDATIONS.**

The 2013 induced polarization survey identified a number of anomalies of potential interest.

Anomaly cA is associated with a moderate intensity resistivity feature at depth, and of potential interest. The shallower drill holes may not have effectively tested the target, and further evaluations of the anomalies in this area should be undertaken.

Anomalies cB and cC appear to be associated a lower resistivity, and given the elevated geochemistry may also be a viable target.

Anomaly cD is a weak deeper feature, however given the proximity to extremely anomalous molybdenum values in rock samples potentially associated with the intense resistivity high on the western end of this line further work in this area should be undertaken.

The historic ground magnetic data shows a somewhat more complex pattern than observed in the fixed wing airborne survey. Additional ground mag should be undertaken over the entire area of interest. This data should then be compiled, and reviewed with the existing data. This would help guide in the planning of additional induced polarization surveying. 3D IP techniques should also be considered in the area surrounding anomaly cA-cC.

**Respectfully submitted,**

**PETER E. WALCOTT & ASSOCIATES LTD.**

**Alexander Walcott  
Geophysicist**

**Peter E. Walcott, P.Eng.  
Geophysicist**

**Coquitlam, B.C.  
January 2014**

**APPENDIX I**

**COST OF SURVEY.**

Peter E. Walcott & Associates Limited undertook the survey programme on a daily basis providing three operators, I.P. equipment, GPS unit, altimeters and partial camp gear. Five days were billed for camp setup, tear down, wire laying and helicopter delay at \$2,200.00, while a further five were billed at \$2,550.00 for IP surveying.

Accommodation costs of \$529.91 were incurred while awaiting helicopter transport, and \$1,000.00 was accrued for report writing.

Thus the total cost of services provided was \$25,279.91.

**PERSONNEL EMPLOYED ON SURVEY.**

<b>NAME</b>	<b>OCCUPATION</b>	<b>ADDRESS</b>	<b>DATES</b>
Peter E. Walcott	Geophysicist	111- 17 Fawcett Rd Coquitlam, B.C.	Jan 21 <sup>st</sup> -25 <sup>th</sup> ,
Alexander Walcott			
Tom Kocan	Geophysical Operator	"	July 13th-21st, 2013
Jordan Steblin	"	"	"
Andy Shongruden	"	"	"

**CERTIFICATION.**

I, Peter E. Walcott, of 605 Rutland Court, Coquitlam, British Columbia, hereby certify that:

1. I am a graduate of the University of Toronto in 1962 with a B.A.Sc. in Engineering Physics, Geophysics Option.
2. I have been practicing my profession for the last fifty one years.
3. I am a member of the Association of Professional Engineers of British Columbia and Ontario.
4. I hold no interest, direct or indirect, in Cathro Resources, nor do I expect to receive any.

**Peter E.Walcott, P.Eng.**

**Coquitlam, B.C.  
January 2014**

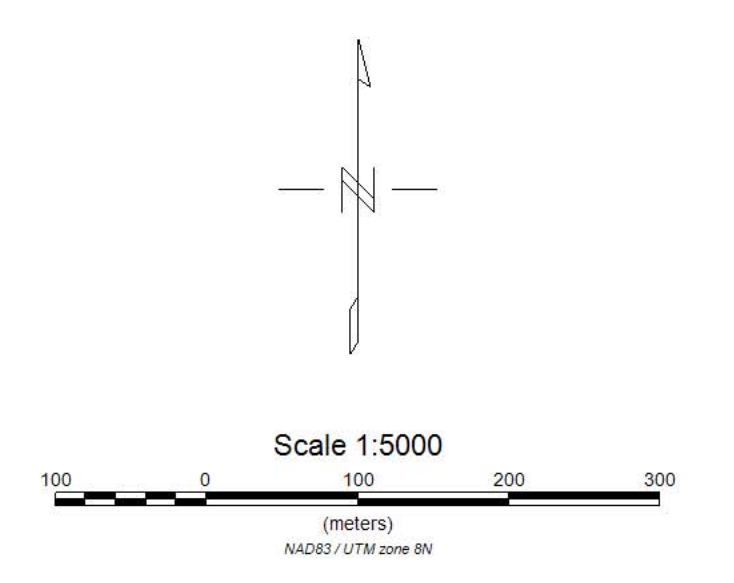
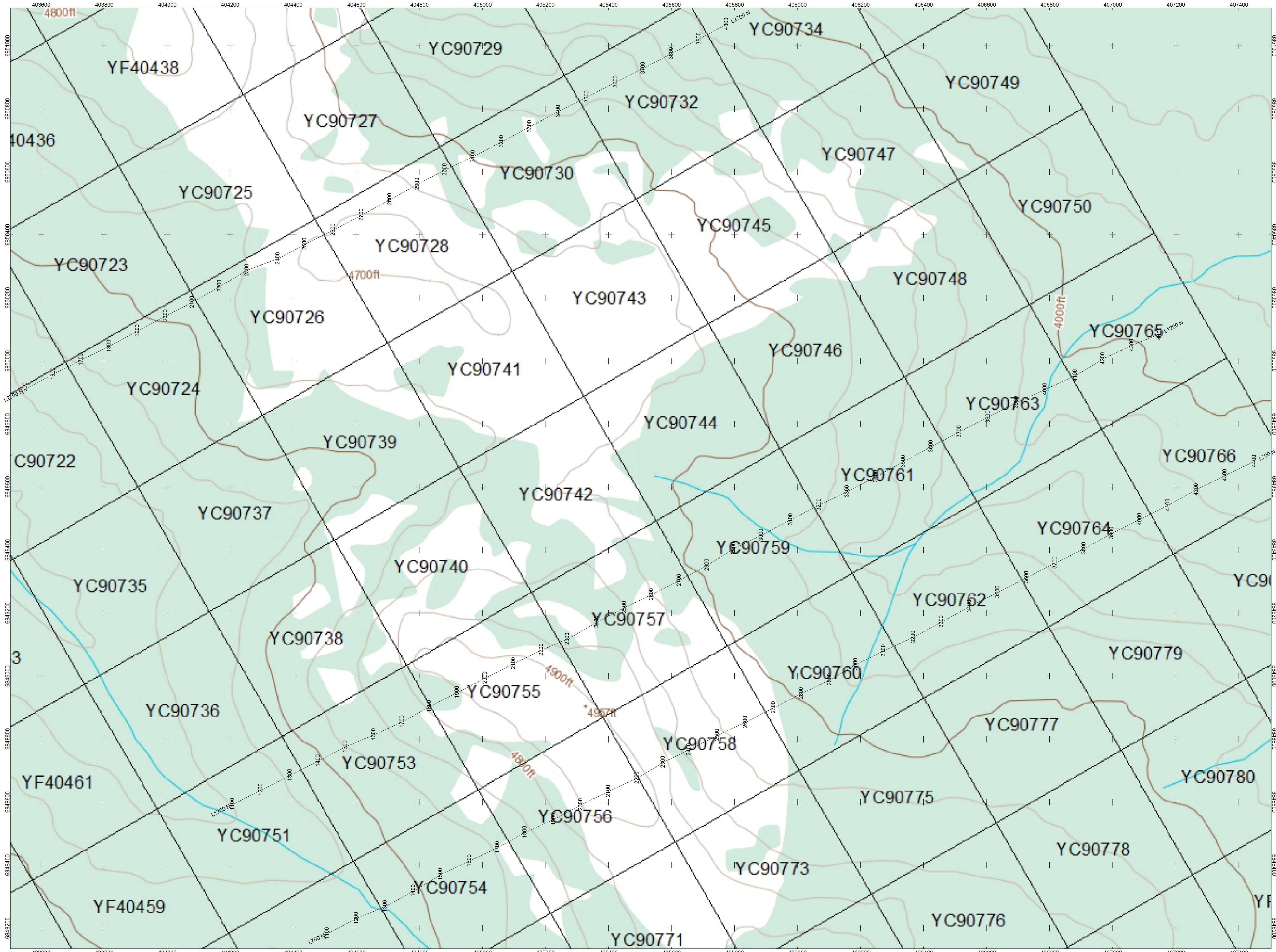

CATHRO RESOURCE CORP  
 INDUCED POLARIZATION SURVEY  
 CLAIM AND LINE LOCATION MAP  
 TAHE PROJECT,  
 CARMACKS AREA, YUKON  
 JULY 2013  
 PETER E. WALCOTT & ASSOCIATES LIMITED



Average IP  
mV/V

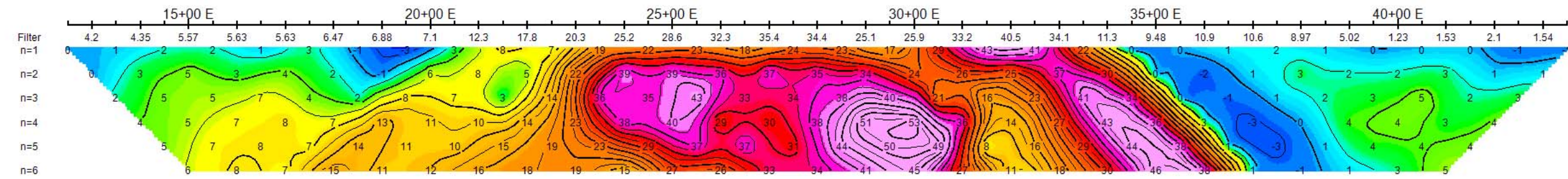

Average IP  
mV/V

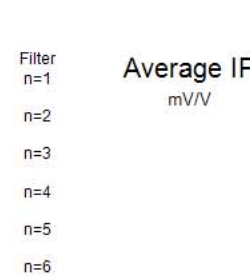

### Pseudo Section Plot 7+00 N

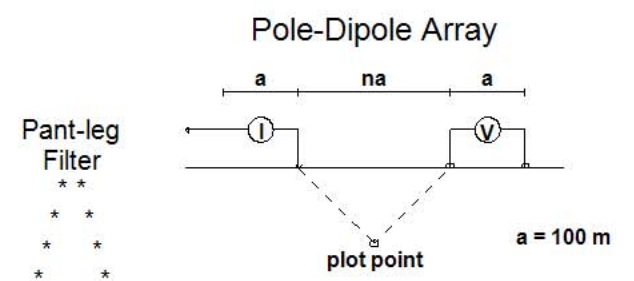

Logarithmic Contours  
1.5, 2, 3, 5, 7.5, 10,...

#### INTERPRETATION

- Strong increase in polarization accompanied by marked decrease in resistivity.
- Well defined increase in polarization without marked resistivity decrease.
- Poorly defined polarization increase with no resistivity signature.
- ▼ Low resistivity feature.

Calculated Resistivity  
Ohm\*m

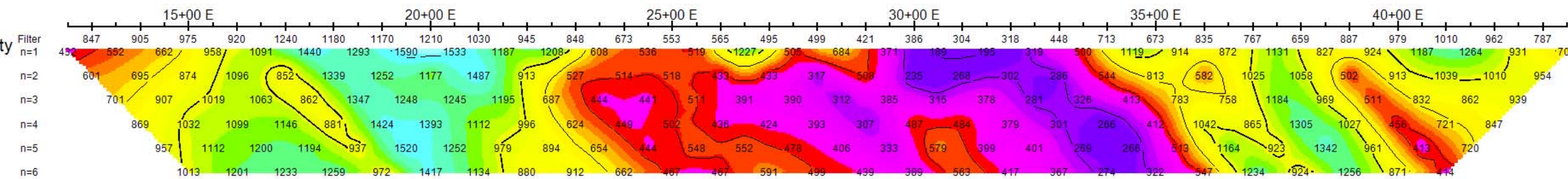

Calculated Resistivity  
Ohm\*m

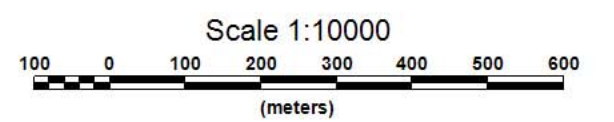
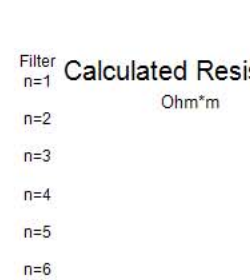

CATHRO RESOURCES CORP.

INDUCED POLARIZATION SURVEY  
TAHTE PROPERTY  
CARMACKS AREA

Date: 16/08/2013  
Interpretation:

PETER E. WALCOTT & ASSOCIATES LIMITED

Average IP  
mV/V

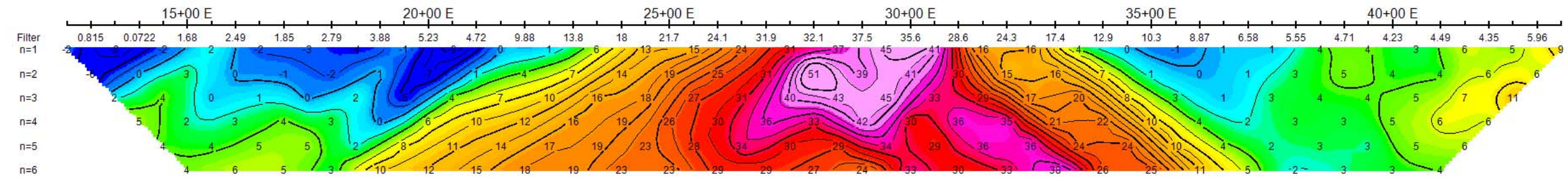

Average IP  
mV/V

### Pseudo Section Plot 12+00 N

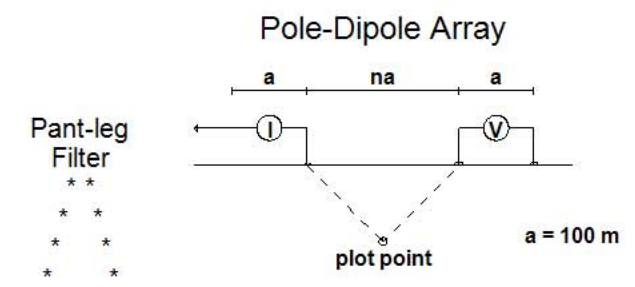

Logarithmic  
Contours 1.5, 2, 3, 5, 7.5, 10,...

#### INTERPRETATION

- Strong increase in polarization accompanied by marked decrease in resistivity.
- Well defined increase in polarization without marked resistivity decrease.
- Poorly defined polarization increase with no resistivity signature.
- ▼ Low resistivity feature.

Calculated Resistivity  
Ohm\*m

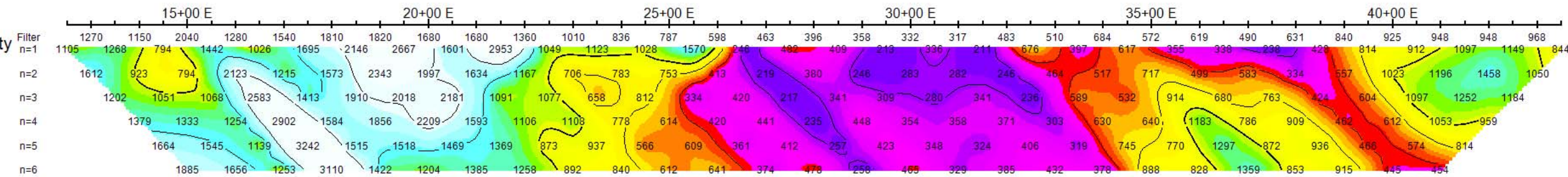

Calculated Resistivity  
Ohm\*m

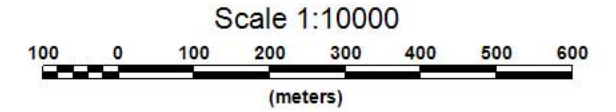

**CATHRO RESOURCES CORP.**

**INDUCED POLARIZATION SURVEY  
TAHTE PROPERTY  
CARMACKS AREA**

Date: 16/08/2013  
Interpretation:

**PETER E. WALCOTT & ASSOCIATES LIMITED**

Average IP  
mV/V

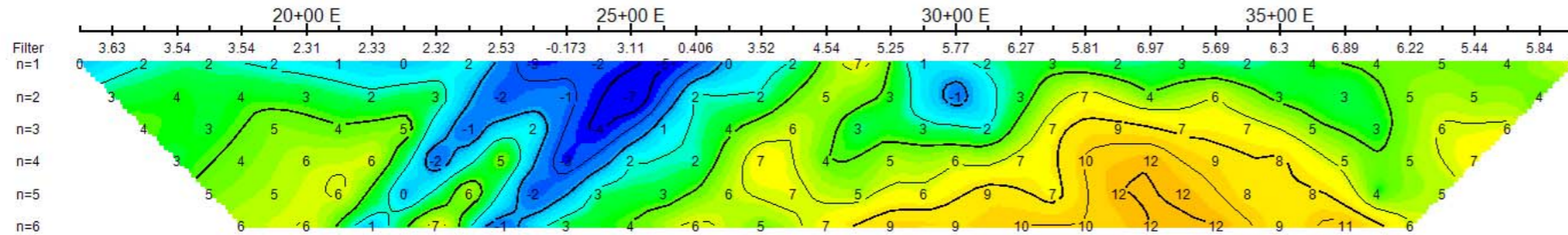

Average IP  
mV/V

### Pseudo Section Plot 27+00 N

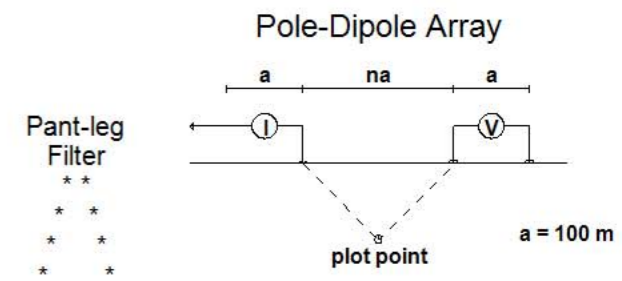

Logarithmic  
Contours 1.5, 2, 3, 5, 7.5, 10,...

#### INTERPRETATION

- Strong increase in polarization accompanied by marked decrease in resistivity.
- Well defined increase in polarization without marked resistivity decrease.
- Poorly defined polarization increase with no resistivity signature.
- ▼ Low resistivity feature.

Calculated Resistivity  
Ohm\*m

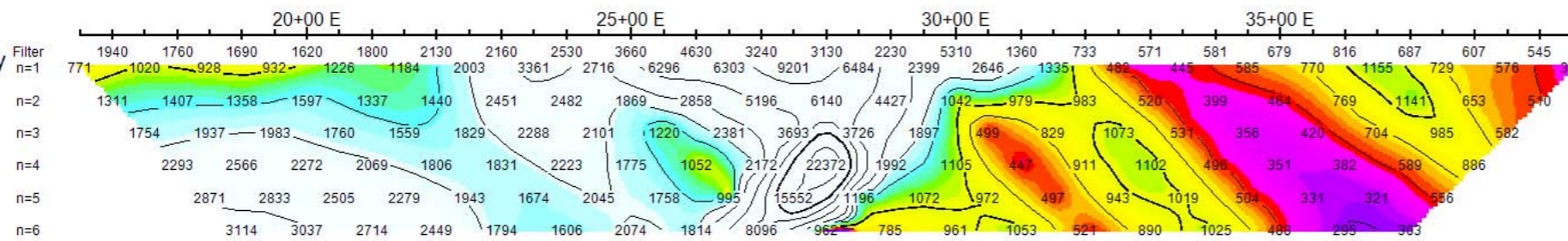

Calculated Resistivity  
Ohm\*m

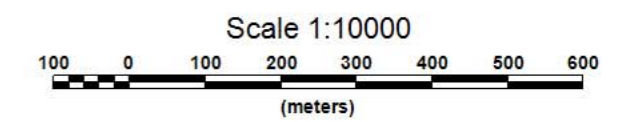

**CATHRO RESOURCES CORP.**

**INDUCED POLARIZATION SURVEY  
TAHTE PROPERTY  
CARMACKS AREA**

Date: 16/08/2013  
Interpretation:

**PETER E. WALCOTT & ASSOCIATES LIMITED**

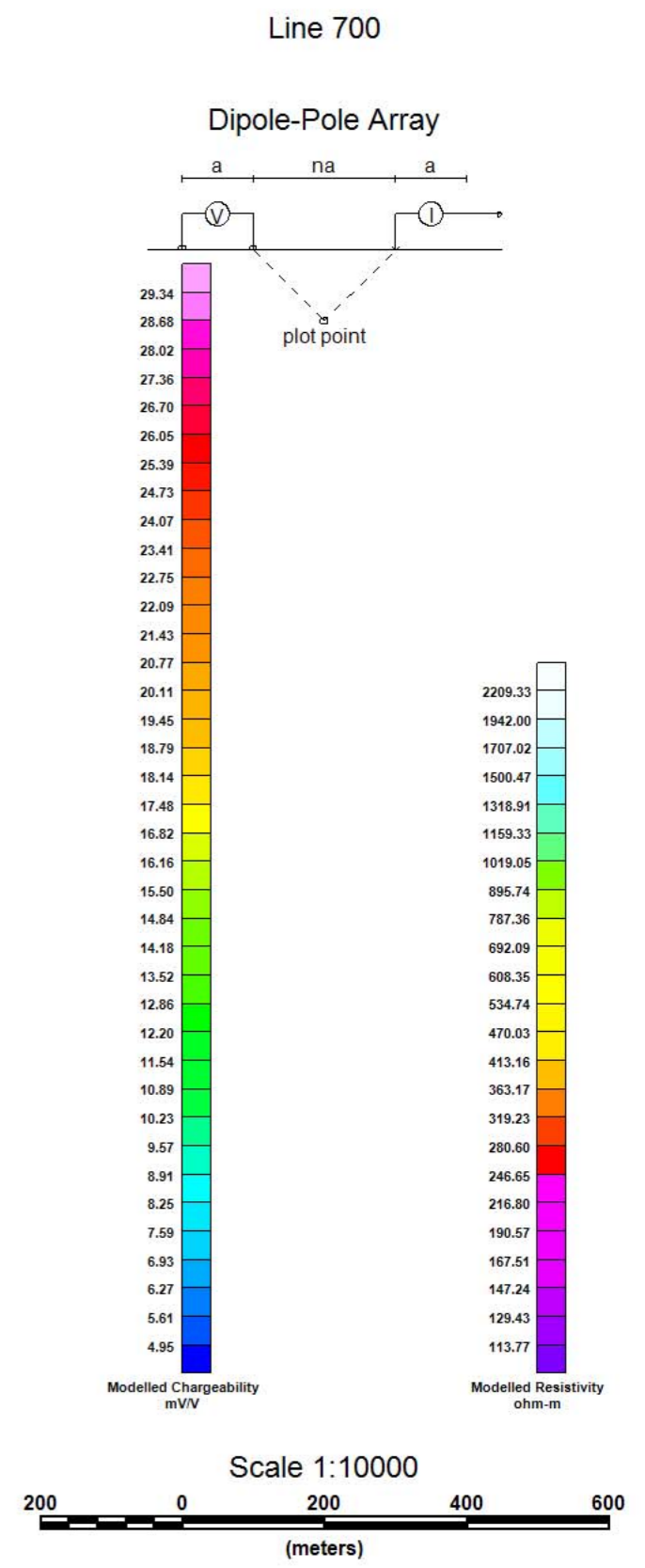
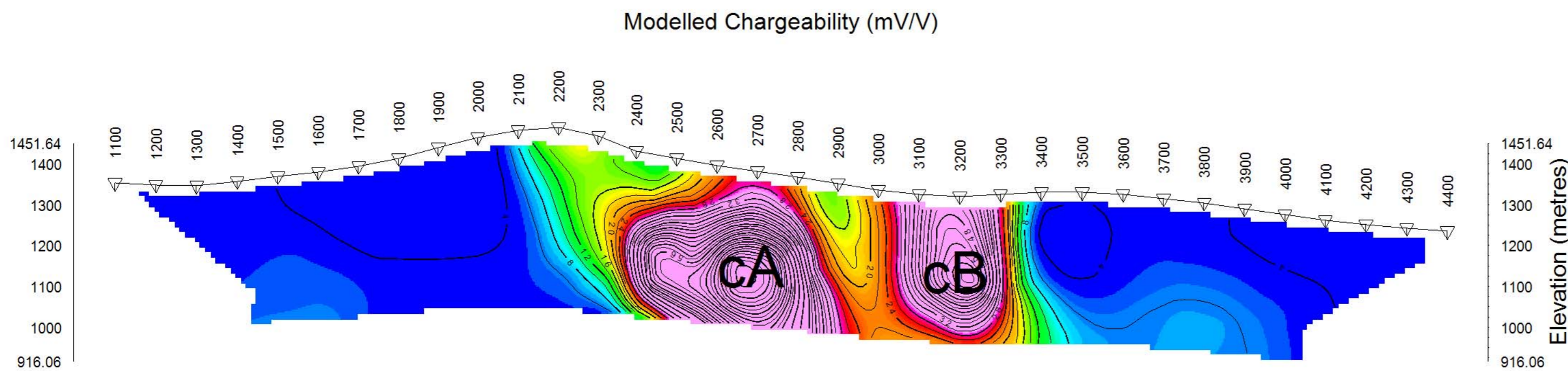
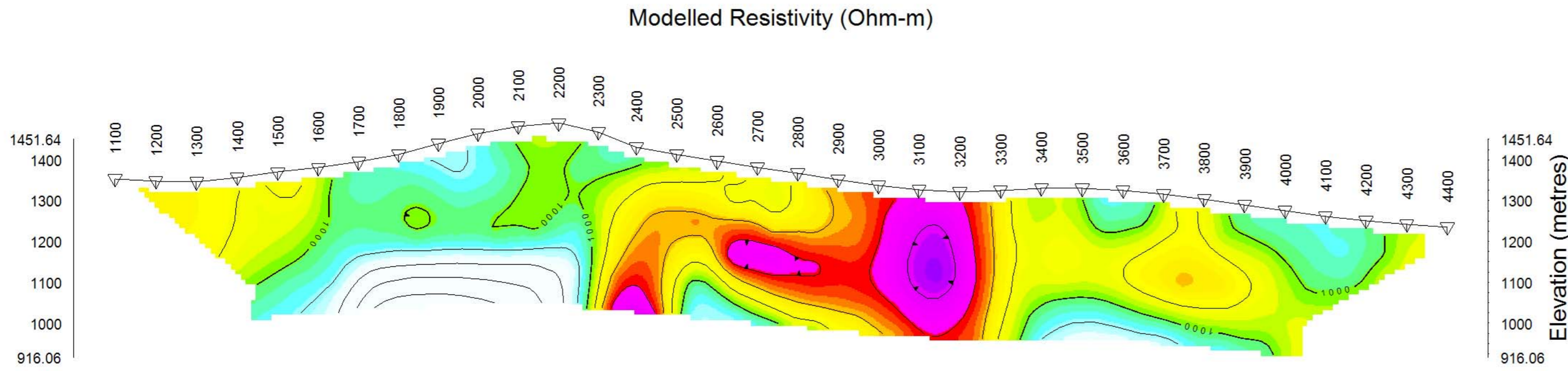

**CATHRO RESOURCES CORP.**  
 INDUCED POLARIZATION SURVEY  
 TAhte PROPERTY  
 BRITISH COLUMBIA  
 Date: JULY 2013  
 RES2DINV  
 Inversion By: PETER E. WALCOTT & ASSOCIATES LIMITED

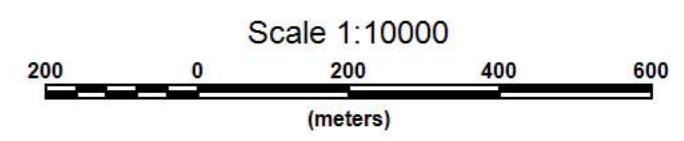
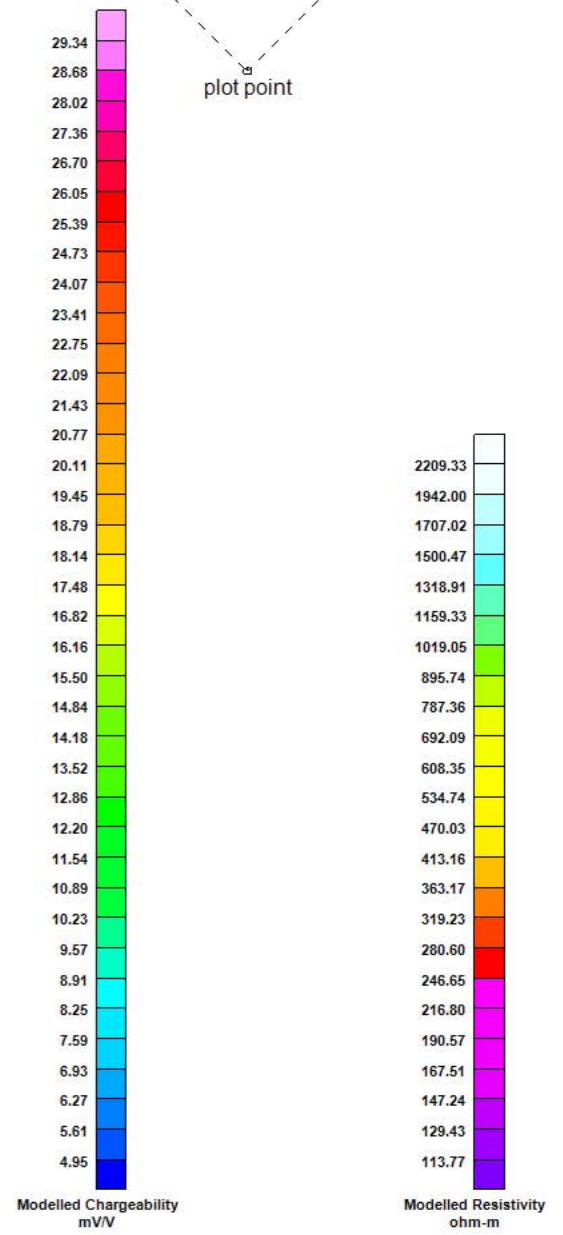
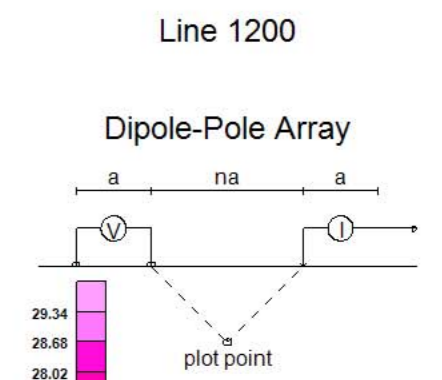
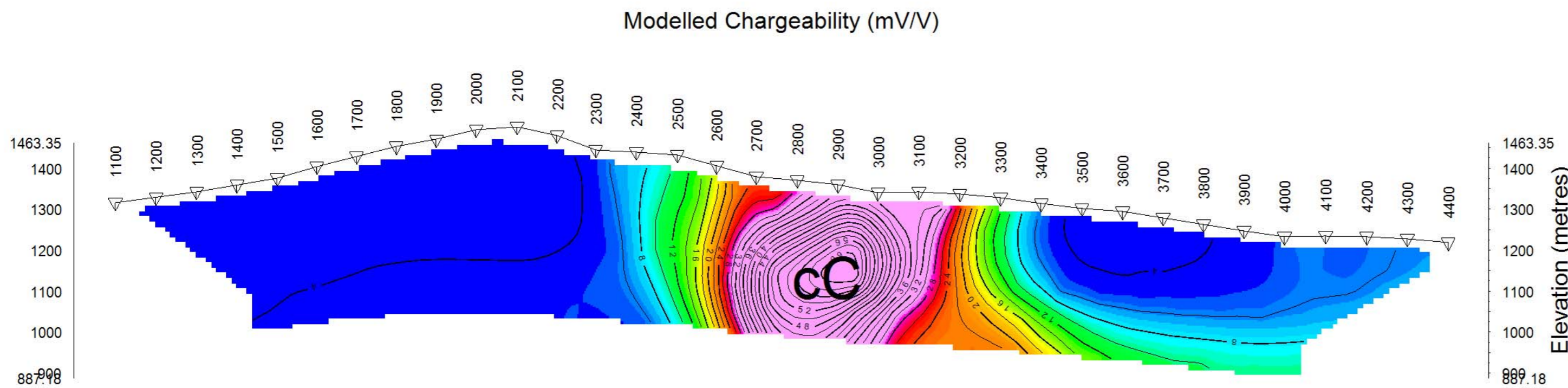
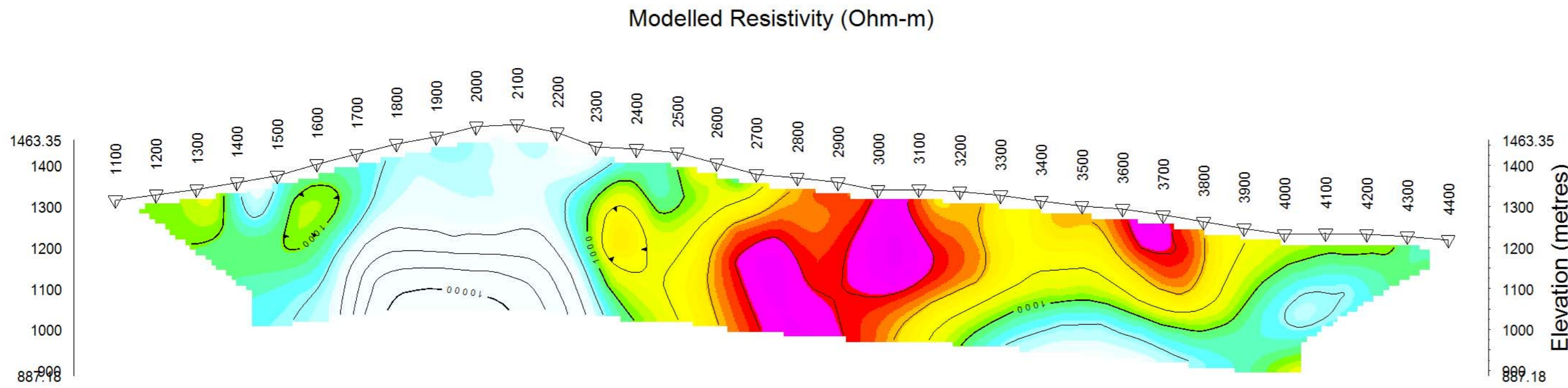

**CATHRO RESOURCES CORP.**  
 INDUCED POLARIZATION SURVEY  
 TAHE PROPERTY  
 BRITISH COLUMBIA

Date: JULY 2013  
 RES2DINV

Inversion By: PETER E. WALCOTT & ASSOCIATES LIMITED

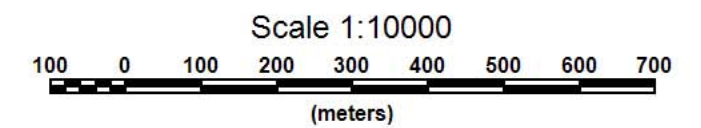
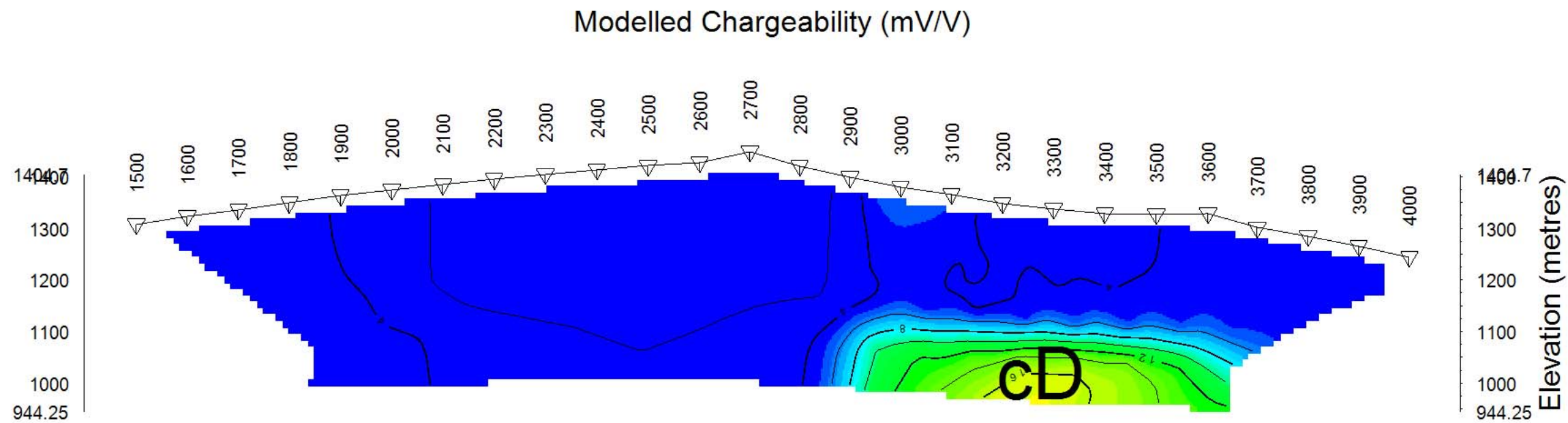
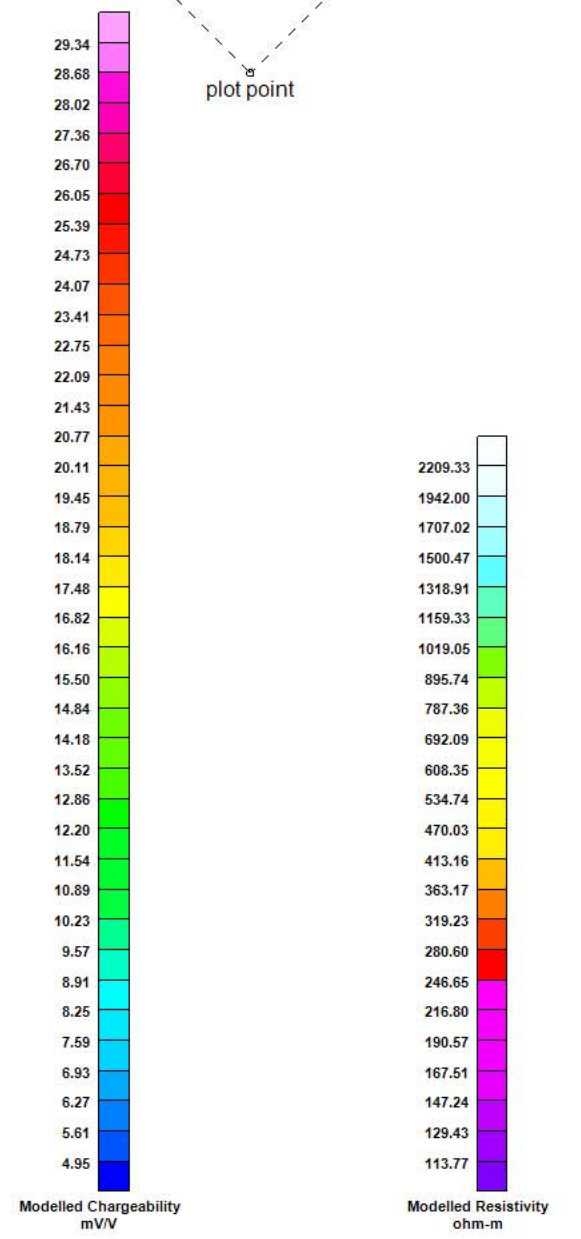
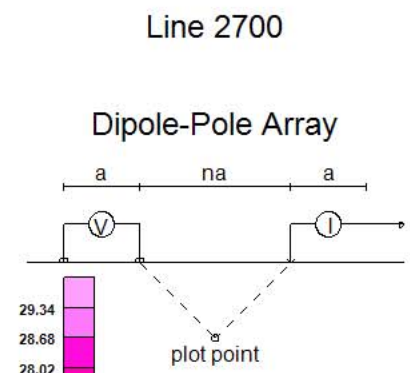
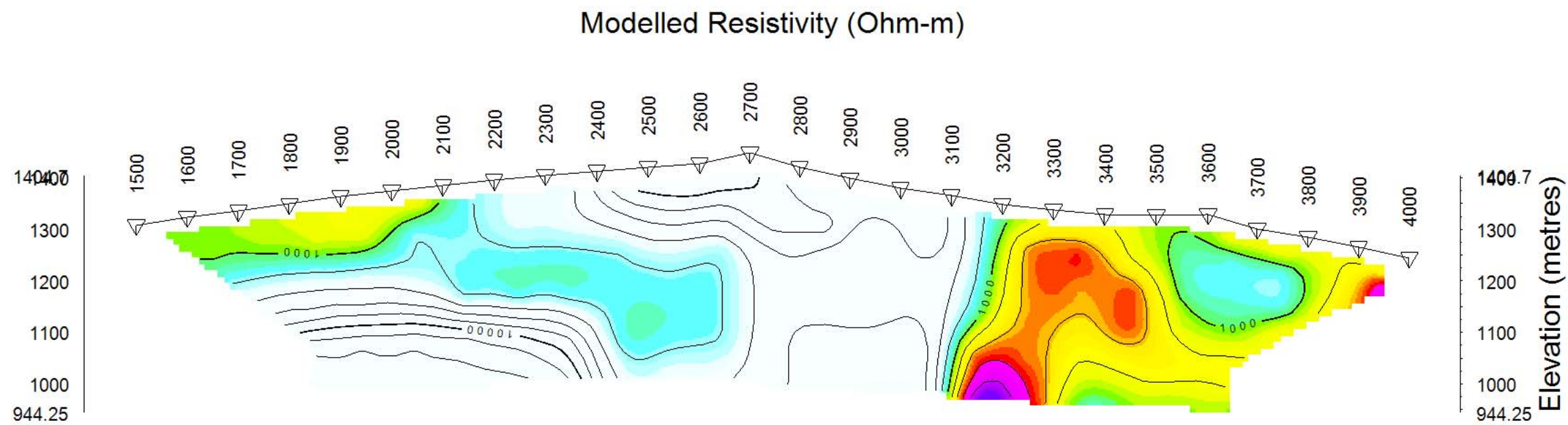

<b>CATHRO RESOURCES CORP.</b>
INDUCED POLARIZATION SURVEY TAHTE PROPERTY BRITISH COLUMBIA
Date: JULY 2013 RES2DINV
Inversion By: PETER E. WALCOTT & ASSOCIATES LIMITED



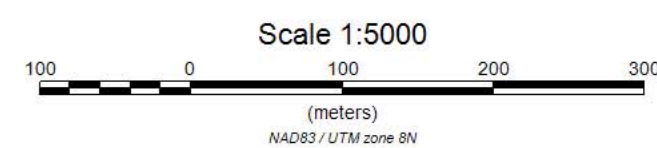
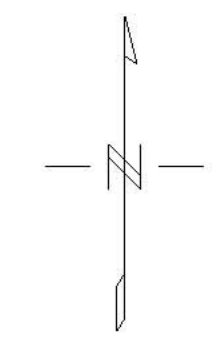
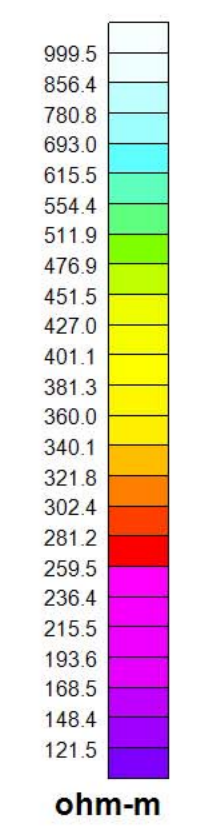
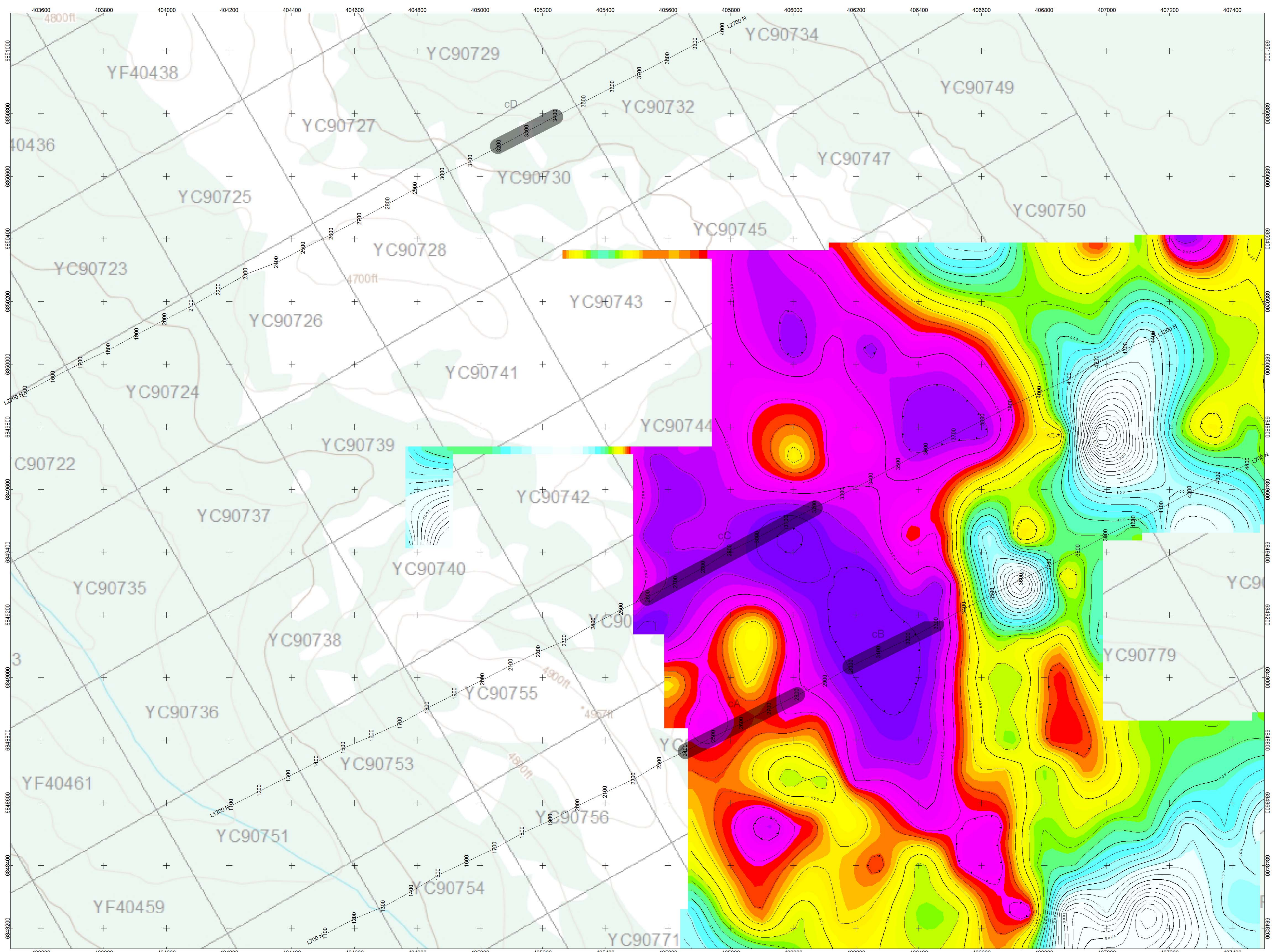

**CATHRO RESOURCE CORPORATION**  
**HISTORIC INDUCED POLARIZATION SURVEY**  
**CONTOURS OF APPARENT RESISTIVITY (OHM-M)**  
 TAITE PROJECT,  
 CARMACKS AREA, YUKON  
 JULY 2013  
**PETER E. WALCOTT & ASSOCIATES LIMITED**

