

ARCHER, CATHRO & ASSOCIATES (1981) LIMITED
1016 - 510 West Hastings Street
Vancouver, B.C. V6B 1L8

Telephone: 604-688-2568

Fax: 604-688-2578

ASSESSMENT REPORT

describing

**GEOCHEMICAL SAMPLING, PROSPECTING AND PRELIMINARY ECONOMIC
ASSESSMENT**

at the

RAU TREND

RR 1 - 222

T 1 – 747, 1072 - 1521, 3126 - 3131

NTS 106C03, 04, 05, 06 and 106D/01, 02, 06, 07, 08
Latitude 64°07'N to 64°27'N; Longitude 133°18'W to 135°21'W

in the

Mayo Mining District,
Yukon Territory

prepared by

Archer, Cathro & Associates (1981) Limited

for

ATAC RESOURCES LTD.

by

J. Lane, P.Geo.

and

R. Phillips, GIT.

September 2015

CONTENTS

INTRODUCTION	1
PROPERTY LOCATION, CLAIM DATA, ACCESS AND INFRASTRUCTURE	1
HISTORY AND PREVIOUS WORK	3
GEOMORPHOLOGY AND CLIMATE	7
REGIONAL GEOLOGY	7
PROPERTY GEOLOGY	9
MINERALIZATION	11
ROCK GEOCHEMISTRY	12
SOIL GEOCHEMISTRY	12
TIGER DEPOSIT PRELIMINARY ECONOMIC ASSESSMENT	13
DISCUSSION AND CONCLUSIONS	13
REFERENCES	15

TABLES

I	REGIONAL LITHOLOGICAL UNITS
---	-----------------------------

APPENDICIES

I	STATEMENTS OF QUALIFICATIONS
II	STATEMENT OF EXPENDITURES
III	ROCK SAMPLE DESCRIPTIONS
IV	CERTIFICATES OF ANALYSIS
V	TIGER PRELIMINARY ECONOMIC ASSESSMENT

FIGURES

<u>No.</u>	<u>Description</u>	<u>Follows Page</u>
1	PROPERTY LOCATION	1
2	CLAIM LOCATION – G AND H BLOCK	In Pocket
3	PROJECT INFRASTRUCTURE	2
4	TECTONIC SETTING	7
5	REGIONAL GEOLOGY	9
6	2014 ROCK SAMPLE LOCATION PUMA	12
7	2014 GOLD IN ROCK PUMA	12
8	2014 SOIL SAMPLE LOCATION G BLOCK	12
9	2014 SOIL SAMPLE LOCATION H BLOCK 1	12
10	2014 SOIL SAMPLE LOCATION H BLOCK 2	12
11	2014 SOIL SAMPLE LOCATION H BLOCK 3	In Pocket
12	2014 ARSENIC SOIL GEOCHEMISTRY G BLOCK	12
13	2014 ARSENIC SOIL GEOCHEMISTRY H BLOCK 1	12
14	2014 ARSENIC SOIL GEOCHEMISTRY H BLOCK 2	12
15	2014 ARSENIC SOIL GEOCHEMISTRY H BLOCK 3	In Pocket

INTRODUCTION

The Rau Trend is located on the western half of the Rackla Gold Property in East-Central Yukon which and comprises a 1700 km² area of highly prospective platform to basin facies sedimentary rocks located along the northern edge of the Tintina Gold Belt. Various commodities have been explored for and discovered within the claim block. Historically, this exploration focused on base metal mineralization, while recently exploration has been directed towards gold potential. The Rau Trend is concentrated around the Tiger gold deposit, a carbonate replacement gold deposit. The property is owned 100% by ATAC Resources Ltd. (ATAC).

This report describes a work completed at the Rau Trend in 2014, including:

- i) Geochemical sampling and geologic mapping at the Puma target four kilometers East of the Tiger Deposit conducted from August 3 to 5.
- ii) Geochemical sampling conducted 21 to 55 km east of the Tiger Deposit on July 17 and from September 3 to 12.
- iii) A copy of the preliminary economic assessment studying conceptual mining and processing of the oxide component of the Tiger Gold Deposit which were published in compliance with disclosure and reporting requirements of the Canadian Securities Administration under provisions of National Instrument 43-101.

Management of this work was provided by Archer, Cathro & Associates (1981) Ltd, on behalf of ATAC. The author's supervised the program, and their statement of qualification appears in Appendix I. A statement of expenditures is in Appendix II

PROPERTY LOCATION, CLAIM DATA, ACCESS AND INFRASTRUCTURE

The Rau Trend consists of 1425 contiguous mineral claims located from 64°07'N to 64°27'N latitude and stretching from 133°18'W to 135°21'W longitude on NTS map sheets 106C/03, 04, 05, 08 and 106D/01, 02, 06, 07, 08 (Figure 1). The claims are all registered with the Mayo Mining Recorder in the name of Archer, Cathro and Associates (1981) Ltd., which holds them in trust for ATAC. Specifics concerning claim registration are tabulated below while the locations of individual claims are shown on Figure 2.

	<u>Claim Name</u>	<u>Grant Number</u>	<u>Expiry Date*</u>
RR	1 - 222	YC89701 - YC89922	28-Apr-20
T	1 - 202	YD09731 - YD09932	1-Mar-20
T	203 - 214	YD09933 - YD09944	1-Mar-22
T	215 - 236	YD09945 - YD09966	1-Mar-20
T	237 - 246	YD09967 - YD09976	1-Mar-22
T	247 - 270	YD09977 - YD10000	1-Mar-20
T	271	YD10001	1-Mar-22
T	272	YD10002	1-Mar-20
T	273	YD10003	1-Mar-22

ATAC RESOURCES LTD.

FIGURE 1
ARCHER, CATHRO & ASSOCIATES (1981) LIMITED

PROPERTY LOCATION
RACKLA GOLD PROJECT

0 250 km

FILE: ...F_1_Property_Location.wor

DATE: SEPT 2015

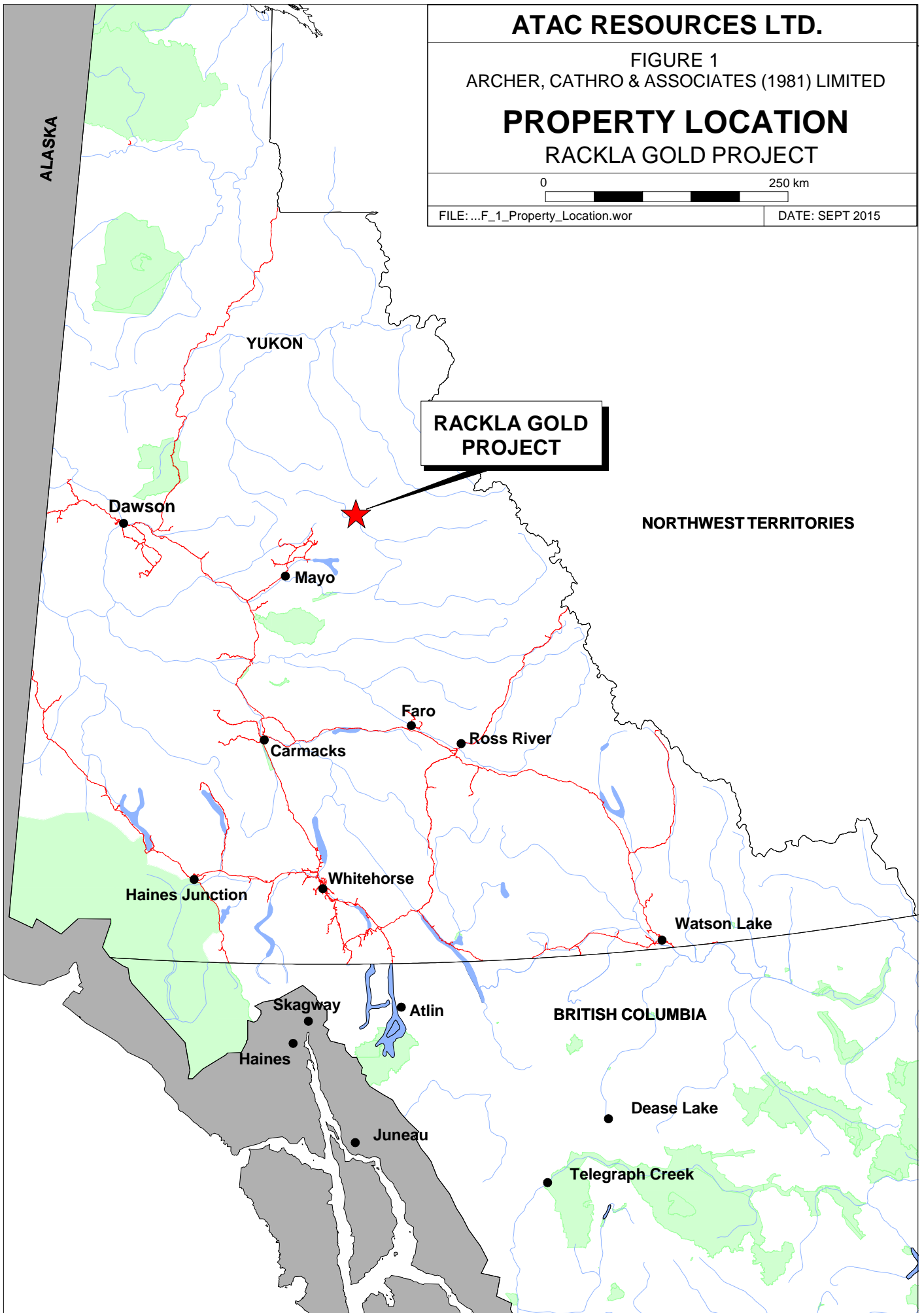

T	274	YD10004	1-Mar-20
T	275 - 292	YD10005 - YD10022	1-Mar-22
T	293 - 322	YD10023 - YD10052	1-Mar-20
T	323 - 338	YD10053 - YD10068	1-Mar-22
T	339 - 374	YD10069 - YD10104	1-Mar-20
T	375	YD10105	1-Mar-22
T	376	YD10106	1-Mar-20
T	377	YD10107	1-Mar-22
T	378	YD10108	1-Mar-20
T	379 - 384	YD10109 - YD10114	1-Mar-22
T	385 - 426	YD10115 - YD10156	1-Mar-20
T	427 - 430	YD10157 - YD10160	1-Mar-22
T	431 - 472	YD10161 - YD10202	1-Mar-20
T	473	YD10203	1-Mar-22
T	474	YD10204	1-Mar-20
T	475 - 476	YD10205 - YD10206	1-Mar-22
T	477 - 670	YD10207 - YD10400	1-Mar-20
T	671 - 747	YD22801 - YD22877	1-Mar-20
T	1072 - 1521	YD23202 - YD23651	1-Mar-20
T	3126 - 3131	YD33156 - YD33161	1-Mar-20

* Expiry dates include 2013 work which has been filed for assessment credit but not yet accepted.

The Rau Trend lies approximately 100 km northeast of Mayo, the nearest supply centre. The closest road access is to the community of Keno City, situated about 49 km by road northeast of Mayo and 55 km by air southwest of the property. Mayo and Keno City can be reached in all seasons by two wheel drive vehicles using the Yukon highway system. The Wind River trail crosses the western portion of the property and is also accessible via the Yukon highway system from McQuesten Lake near Keno City (Figure 3). This winter trail has been used intermittently by various exploration companies since it was built in the late 1960s.

In 2014, access to the property and daily logistical support were accomplished using a Bell 206L4 or MD500 helicopter based on the property or in Mayo and operated by Fireweed Helicopters Ltd. of Whitehorse. Mayo served as a staging area and base of operations for work performed on the Puma claims in August, while the Rackla camp, located 58 km east of the deposit, was used for an operating base for work performed on the G and H claims in September. A gravel airstrip located at the Rackla camp was used to assist in the mobilization of supplies and equipment to the eastern side of the property.

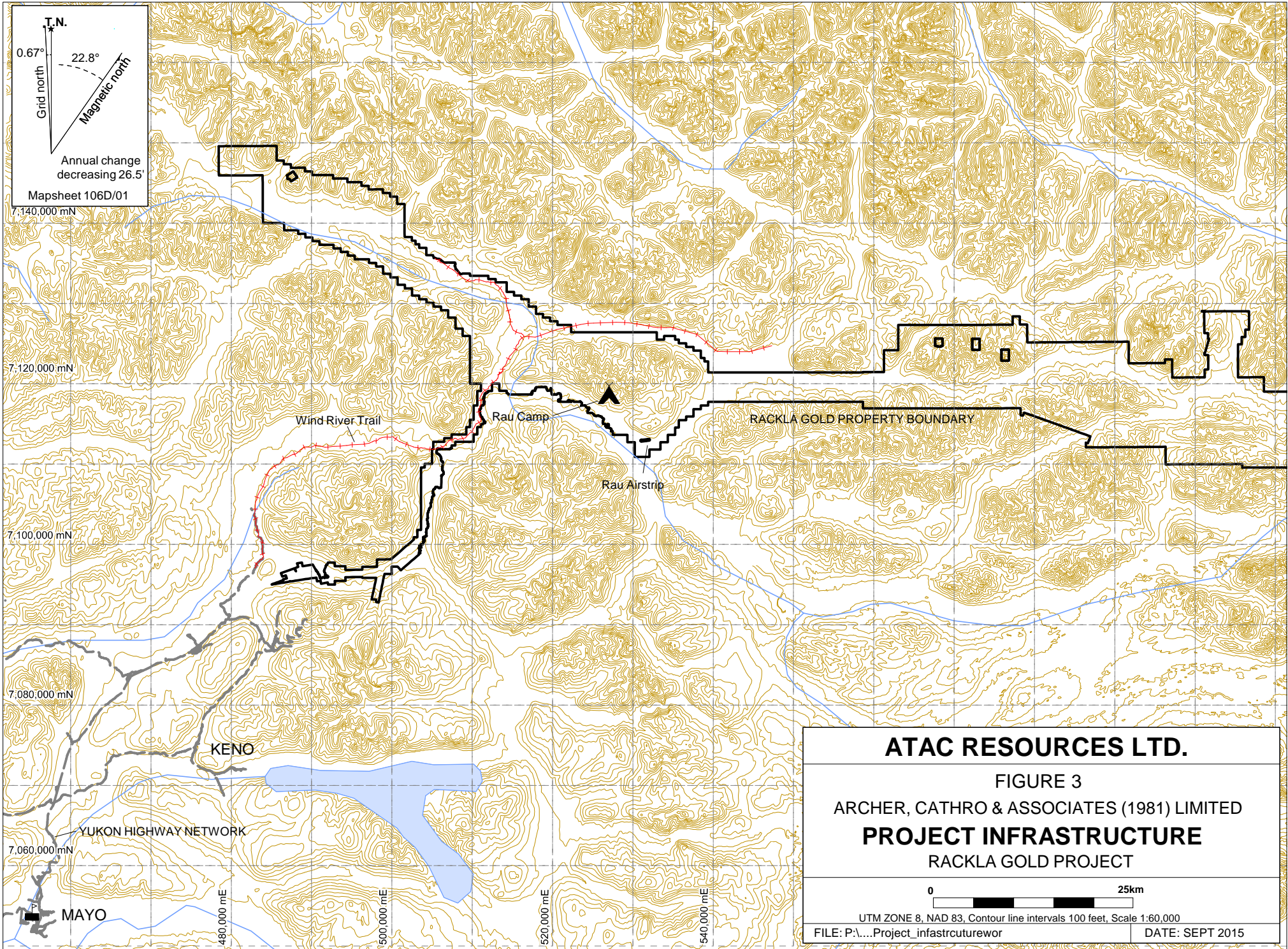

T.N.
 0.67°
 Grid north
 22.8°
 Magnetic north
 Annual change decreasing 26.5'
 Mapsheet 106D/01

7,140,000 mN

7,120,000 mN

7,100,000 mN

7,080,000 mN

7,060,000 mN

480,000 mE

500,000 mE

520,000 mE

540,000 mE

ATAC RESOURCES LTD.

FIGURE 3

ARCHER, CATHRO & ASSOCIATES (1981) LIMITED

PROJECT INFRASTRUCTURE

RACKLA GOLD PROJECT

0 25km

UTM ZONE 8, NAD 83, Contour line intervals 100 feet, Scale 1:60,000

FILE: P:\...Project_infrastruturewor

DATE: SEPT 2015

MAYO

KENO

Wind River Trail

Rau Camp

Rau Airstrip

RACKLA GOLD PROPERTY BOUNDARY

YUKON HIGHWAY NETWORK

HISTORY AND PREVIOUS WORK

The earliest reported exploration within the area of the Rackla Gold Property occurred in 1922 following the discovery of silver mineralization at Keno Hill; prospectors first identified and staked mineralized float occurrences at Carpenter Ridge in the far northwest corner of the current property. In 1924, reconnaissance work conducted by the Geological Survey of Canada discovered galena-calcite-siderite in float on the southwest end of Carpenter Ridge. A sample of this float returned 8.75 oz. silver and 56.0% lead (Cockfield, 1925); however, the source of this mineralization was not found. Hand pits were dug in 1927 and 1928 but little record remains of the work completed during this period. All claims were ultimately dropped.

Nearby at Grey Copper Hill, 9 km to the southeast, silver-rich tetrahedrite float was discovered in 1923 by an independent prospector. This showing and other nearby prospects were staked later that year. Several investigatory adits were dug into the hillside during follow up exploration but eventually all claim holdings lapsed.

Between 1930 and 1974 Grey Copper Hill was staked several times by independent prospectors and exploration companies, including Cypress Resources Limited and United Keno Hill Mines Limited. Little work was reported (Hilker, 1969) and all claims ultimately expired.

Hesca Resources Corporation Ltd. re-staked Grey Copper Hill in 1974 and conducted prospecting, soil sampling, hand trenching and adit maintenance. In addition, two shallow, small diameter diamond drill holes totalling 56.3 m were drilled; however, the results from this drilling are not documented. No further work was done by Hesca and the claims were dropped (Deklerk and Traynor, 2005).

In spring 1978 Prism Resources Limited re-staked the area and conducted prospecting and geochemical sampling later that year. Soil sampling identified several lead and silver anomalies; however, follow up prospecting failed to explain them (Sivertz, 1979). A sample collected from an outcrop of dolomite yielded 0.60% lead and 51.43 g/t silver, while a tetrahedrite sample collected near an old adit assayed 7000 g/t silver (Sivertz, 1980). Prism allowed the claims to lapse.

Grey Copper Hill was again restaked in 1983 by a prospector who conducted grid soil sampling later that year. This program delineated silver anomalies coincident with surface lineations. No further work was completed and the claims expired.

In 1988, Bonventures Limited staked the area and conducted limited blast trenching, prospecting, mapping plus soil and rock sampling. A gossan zone with pyrite and strong fracture filling malachite and azurite was identified between two collapsed adits (Carlyle, 1989). These claims eventually lapsed.

The area remained open until August of 2005 when an independent prospector staked four claims over the Grey Copper Hill showing. No work on these claims has been reported and they are now surrounded by the Rackla Gold Property.

Approximately 45 km to the southeast, Cominco Limited staked the Beaver claims in 1968 based on results of regional geochemical sampling done the year before. Later that year, L. Elliott staked the nearby Now claims and optioned them to Cominco, which completed mapping and soil sampling in 1968 and 1969 (Johnson and Richardson, 1969a and 1969b).

In 1977, Prism Joint Venture (Asamera Oil Corp, Chieftain Development Company Limited, Prism Resources Ltd., Siebens Oil & Gas Limited and E & B Exploration Limited) restaked Cominco's claims as part of a larger block that extended for about 20 km along the north side of the Beaver River. In 1979, Dome Petroleum Ltd. replaced Siebens in the joint venture.

Prism conducted most of its activities around the original Beaver claims. Soil sampling and mapping were performed in 1977 (Montgomery and Dewonck, 1978) and additional soil sampling and trenching were done in 1978 (Prism Joint Venture, 1979a). In 1979, Prism completed six diamond drill holes totalling 610 m (Dewonck, 1980). This work focused primarily on sedimentary exhalite and Mississippi Valley type lead-zinc mineralization, but resulted in the discovery of a narrow gold-rich vein (the Now Showing).

NDU Resources Ltd. staked claims over the Now Showing in 1987 to cover the lead, zinc and silver soil geochemical anomalies identified by Cominco and Prism. The following year, NDU conducted a geochemical sampling program which focused on the gold vein mineralization at the Now Showing (Cathro, 1989).

In 1977, 6.25 km further to the northwest, Prism conducted mapping, soil sampling and electromagnetic surveys. Numerous samples from that program returned high zinc-in-soil values ranging from 2100 ppm to 12.2%. One sample collected from a large transported gossan (Ocelot Showing) yielded 3.8 g/t silver, 800 ppm lead and 12.2% zinc (Montgomery and Cavey, 1978), suggesting the metals were leached and remobilized in acidic groundwater before being reprecipitated when the fluids were neutralized. These promising results were not followed up. Prism also performed minor soil sampling near a strong gossan developed 19 km to the east (Kathy Showing) (Prism Joint Venture, 1979b).

In 1979 and 1980, Prism explored in two areas approximately 16 km southeast of the current Ocelot Showing and conducted prospecting, soil geochemical sampling and one diamond drill hole. This work led to the discovery of scheelite mineralization at the Blue Lite and Flat Top Showings. Well mineralized tremolite skarn specimens from the Flat Top Showing assayed up to 8.4% WO_3 , but most material graded below 0.04% (Churchill, 1980). No further work was done at either showing.

ATAC's interest in the area was prompted by an isolated, high gold value (150 ppb) reported by a regional-scale stream sediment geochemical survey, conducted by the Geological Survey of Canada (Hornbrook, et al 1990). This value is in the 99th percentile of gold results from the survey and is supported by a 99th percentile tungsten value (25 ppm). The sample was collected near the Rackla Pluton, east of the Tiger Zone.

In summer 2006, ATAC staked 64 claims to cover the anomalous drainage. During the staking, a number of rock and soil samples were collected, many of which returned anomalous values for tungsten and a few were notably enriched in gold, lead, zinc, silver and copper. cursory prospecting relocated scheelite-bearing tremolite skarn (Flat Top Showing) and discovered tungsten in diopside-actinolite skarn and highly fractionated intrusive rocks, about 1500 m to the south.

In 2007, ATAC completed geological mapping, prospecting, grid soil sampling and helicopter-borne variable time-domain electromagnetic (VTEM) surveys (Eaton and Panton, 2008). This work partially delineated a large hydrothermal system centered on the largely buried Rackla Pluton. Following that program, ATAC staked an additional 32 claims, mostly to improve coverage around a very strong gold-in-soil anomaly outlined on the western edge of the grid.

ATAC and Yankee Hat Minerals Limited signed an option agreement in spring 2008 concerning 40 claims that covered the Rackla Pluton and the tungsten-bearing skarns. During the summer of 2008 Yankee Hat conducted prospecting and a total of 437.38 m of diamond drilling in three holes (Dumala, 2008). Several narrow skarn bands with weak to moderate tungsten mineralization were identified within the carbonate host rocks. The option agreement was terminated in late 2008 following poor results and the claims were returned to ATAC.

Also in the summer of 2008, ATAC conducted geological mapping, prospecting, soil and stream sediment geochemical sampling, 3,423.21 m of diamond drilling in 18 holes and property-wide helicopter-borne magnetic variable time-domain electromagnetic (VTEM) surveys on the claims not covered by the Yankee Hat option agreement. Drilling identified three stacked, gold-bearing horizons in what is now known as the Tiger Zone (Dumala, 2009). The central horizon (Discovery Horizon) contains gold in iron carbonate replacement and hosts the most abundant mineralization. In 2008 grid soil sampling and stream sediment sampling was extended to the northwest. In response to positive results, ATAC added 1,340 claims to cover the favourable stratigraphy along the anomalous trend.

In 2009, ATAC continued to delineate the Tiger Zone with an additional 58 diamond drill holes totalling 9,578.30 m (Dumala and Lane, 2010). Drilling identified a significant oxide component to the northwest, within the Tiger Deposit. Prospecting in 2009 also identified several new showings containing mineralization similar to that found at the Tiger Deposit. These include the Cub, Lion, Jaguar, Panther, Cougar, Puma, Cheetah and Lynx Showings.

In 2010, ATAC continued definition drilling at the Tiger Zone resulting in the completion of a NI 43-101 compliant resource estimate of the sulphide and oxide horizons (Stroshein, et al 2011). Results of the resource estimate using a 0.3 g/t gold cut off yield an indicated resource estimate of 508,000 ounces of gold (7,150,000 tonnes at an average grade of 2.21 g/t) and an inferred resource estimate of 290,200 ounces of gold (8,280,000 tonnes at an average grade of 1.09 g/t) for the oxide and sulphide horizons combined.

In conjunction with the resource estimate, mineralogy and cyanide leaching characteristics of the Tiger deposit oxide ore were investigated (Stroshein, et al 2011). This work consisted of bottle roll and carbon-in-pulp/carbon-in-leach tests on finely ground (69µm – 131µm) material, aimed at investigating leaching characteristics which would be representative of those expected in a milling scenario. This test program also included gravity recoverable gold tests to investigate viability of gravity recovery, and acid base accounting to characterize the acid rock drainage potential of the Tiger deposit oxide material.

Prospecting at the geochemically anomalous Ocelot Showing in 2010 resulted in the discovery of high grade Ag-Pb-Zn massive sulphide mineralization. Grab samples from this area included 2100 g/t Ag, 55.33% Pb and 62 g/t In (Dumala, 2011).

In 2011, ATAC drilled 10 holes totaling 2,113.2 m of diamond drilling at the Now Showing (3 holes) Puma Showing (2 holes) Cheetah Showing (3 holes) and Kathy Showing (2 holes). Weakly anomalous gold, silver, lead and zinc values were intersected in one Now drill hole. Puma and Cheetah drilling intersected weak gold mineralization; Kathy drilling intersected no significant results (Dumala, 2012a).

Also in 2011, ATAC drilled 19 holes totaling 3784.75 m at the Ocelot target beneath a known but previously undrilled surface gossan. The best grade intervals yielded 145.43 g/t silver, 3.36% lead and 11.65% zinc across 41.72 m and **188.07 g/t silver, 8.69% lead and 6.06% zinc over 37.91 m** in semi-massive to massive sulphide mineralization. Drilling by the end of the 2011 season identified mineralization over a 230 m strike length and to a depth of 150 m. (Dumala, 2012b). During the field season, the 900 m long Rau gravel airstrip was constructed at the confluence of the Beaver and Rackla rivers.

In 2012, ATAC completed metallurgical testing, heritage resources assessment and ongoing environmental monitoring in relation to the Tiger Deposit (Carne and Lane, 2013). ATAC also completed mapping, geochemical sampling, prospecting and hand trenching on portions of the Rau trend in 2012 (Lane et al, 2013).

In 2013, 1229 soil and 348 rock samples were collected in seven target areas in the Rau Trend. This exploration focused on assessing gold potential at known mineralized showings and geochemical targets. Emphasis at the mineralized targets was directed to follow up of geochemical anomalies that occurred in proximity to receptive stratigraphy (Lane, 2014)

GEOMORPHOLOGY AND CLIMATE

The core portion of the Rau Trend is situated in the Nadaleen Range of the Selwyn Mountains and is drained by creeks that flow into the Rackla and Beaver Rivers, which are both part of the Yukon River watershed. Local topography is alpine to subalpine and features north and south-trending rocky spurs and valleys that flank a main east-west trending ridge. Elevations range from 725 m alongside the Beaver River in the centre of the claim block to 1800 m atop a peak, referred to as Monument Hill. Outcrop is most abundant near ridge crests and in actively eroding creek beds. Most hillsides are talus covered at higher elevations and are blanketed by glacial till at lower elevations. Soil development is moderate to poor in most areas. Treeline in the vicinity of the property is at about 1500 m. Slopes above that elevation are weakly vegetative with willow, buckbrush and grass. The density and size of vegetation gradually increases on lower slopes, and the valley floors are well treed with mature black spruce. Understorey typically consists of low shrubs and moss. Moderately steep, south facing slopes are well drained and are often lightly forested with poplar. Steep, north facing slopes are usually unvegetated. Gentler, spruce- and moss-covered terrain likely exhibits widespread permafrost.

REGIONAL GEOLOGY

The Geological Survey of Canada performed geological mapping in the vicinity of the Rau property at 1:250,000 scale in the 1960s (Green, 1972) and 1970s (Blusson, 1978). More recent mapping in the area was completed at 1:50,000 scale by Indian and Northern Affairs Canada (Abbott, 1990 and Roots, 1990).

The Rau property lies within a band of regional-scale thrust and high angle reverse faults that imbricate rocks of Selwyn Basin and Mackenzie Platform (Figure 4). Selwyn Basin stratigraphy consists of regionally metamorphosed, basinal sediments of Neoproterozoic to Paleozoic age. Mackenzie Platform stratigraphy comprises dominantly shallow water carbonate and clastic sediments that were deposited from Mid-Proterozoic through Paleozoic times. Both packages of sediments were deposited on the western margin of ancestral North America.

Thrust faults were active during Jurassic to Cretaceous times (160 to 130 Ma), when the area underwent compressional orogenesis related to large-scale plate convergence (Fingler, 2005). During the Late Cretaceous (94-90 Ma), intermediate to felsic plutons of the Tombstone Suite were emplaced (Mortensen et al, 2000). Another compressional orogenic event, which occurred about 65 Ma, was accompanied by emplacement of felsic intrusions assigned to the McQuesten Suite.

The Tombstone, Dawson and Robert Service thrust faults in addition to a number of lesser thrust faults affect stratigraphy along the trend of the Rau Trend. All thrusts verge northeasterly and predate emplacement of the Tombstone Suite intrusions. The thrust panel that contains the Rau Trend approximately straddles the boundary between Selwyn Basin and Mackenzie Platform and includes units belonging to both tectonic elements.

ATAC RESOURCES LTD.

FIGURE 4

ARCHER, CATHRO & ASSOCIATES (1981) LIMITED

TECTONIC SETTING

RACKLA GOLD PROPERTY

FILE: P:/2013.cdr

DATE: SEPTEMBER 2015

After Colpron, M. and Nelson, J.L., 2011

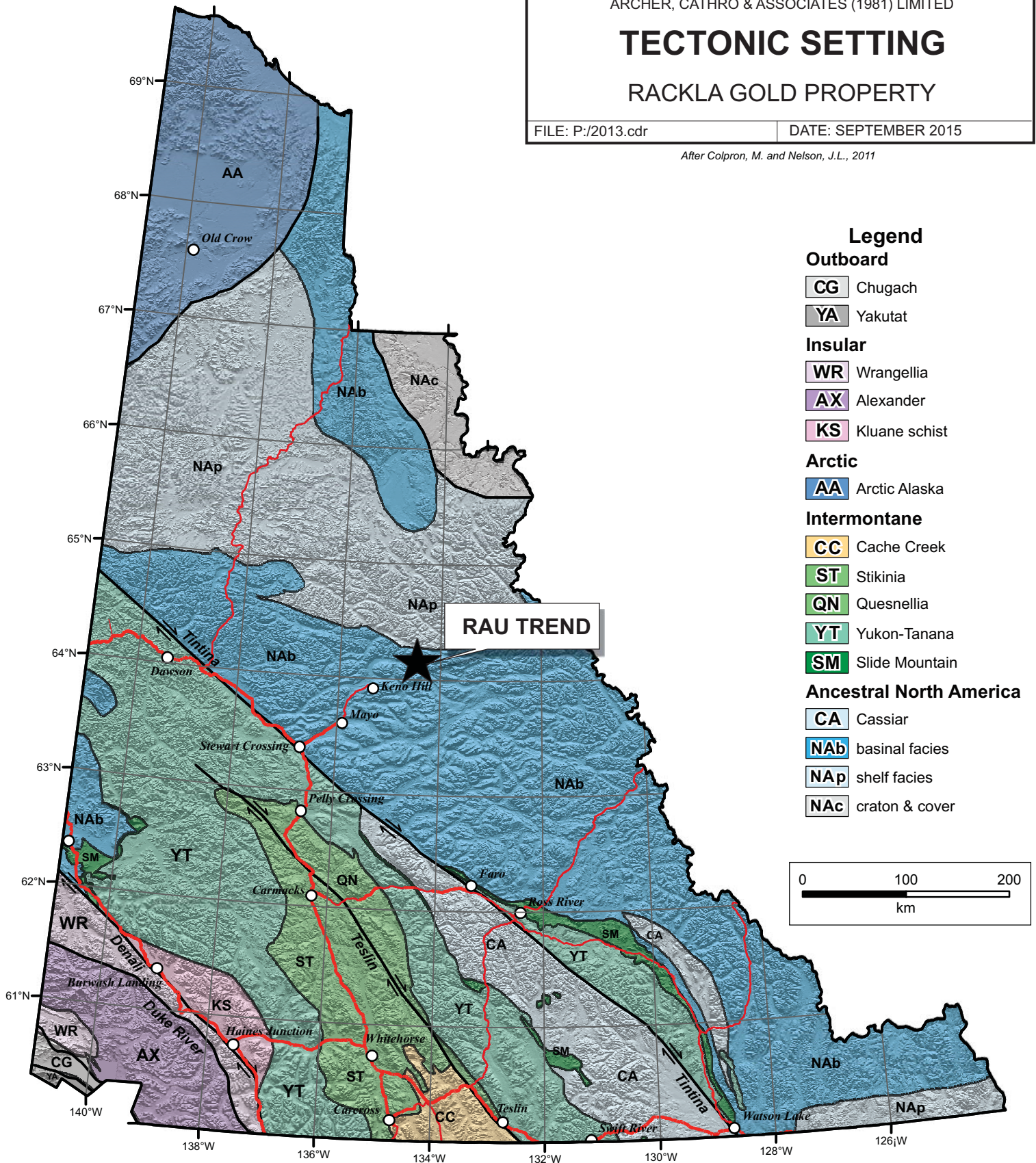

Legend

Outboard

CG Chugach

YA Yakutat

Insular

WR Wrangellia

AX Alexander

KS Kluane schist

Arctic

AA Arctic Alaska

Intermontane

CC Cache Creek

ST Stikinia

QN Quesnellia

YT Yukon-Tanana

SM Slide Mountain

Ancestral North America

CA Cassiar

NAb basinal facies

NAp shelf facies

NAc craton & cover

Table I contains a brief summary of the main lithologies in the area of the Rau property.

Table I: Regional Lithological Units (after Roots *in* Cathro, 2006)

<u>Tectonic Element</u>	<u>Age (Ma)</u>	<u>Unit and Lithologies</u>
<u>Rocks of Ancestral North America</u>		
Mackenzie Platform	1700 - 1800	Gillespie Lake Group: orange-brown dolostone and sandstone.
Mackenzie Platform	540 - 390	Bouvette Formation: white and grey limestone with rare black shale.
Mackenzie Platform	540 - 420	Marmot Formation: dark green to brown mafic, vesicular and amygdaloidal volcanic flows.
Selwyn Basin	750? - 530	Hyland Group: brown quartz-mica schist, with rare limestone.
Selwyn Basin	530 - 500	Gull Lake Formation: brown and green shale, sandstone, conglomerate and volcanic tuff.
Selwyn Basin	500 - 480	Rabbitkettle Formation: dark silty limestone and limy mica-rich conglomerate.
Selwyn Basin	480 - 390	Road River Group: black shale, chert and limy siltstone.
<u>Rock formed before orogenic event</u>		
	390 - 350	Earn Group: black shale and chert with lesser pebble conglomerate, sandstone and grit.
	340	Keno Hill Quartzite: grey metamorphosed sandstone, minor black shale and phyllite.
<u>Rocks formed during orogenic event</u>		
	225	Galena Suite intrusions: brown and green diorite and gabbro.
	200 - 250	Jones Lake and Mt. Christie Formations: sandstone, brown shale and dark limestone.

Rocks formed after orogenic event

90 - 94	Tombstone Suite intrusions: granite and granodiorite.
62 - 67	McQuesten Suite intrusions: granite with two types of mica.

Sediments younger than 3 Ma

0 - 3	Overburden: ice-deposited sand and gravel; river silt.
-------	--

PROPERTY GEOLOGY

Very little detailed geological mapping has been conducted within the Rau Trend. Most work has focused within the favourable Bouvette Formation stratigraphy in close proximity to the Tiger Deposit. The following descriptions are taken largely from previously documented government and historical mapping.

The Rau Trend lies within a northwest trending thrust package bound to the south by the Dawson Thrust and to the north by the Kathleen Lakes Fault. Property scale geology is illustrated on Figure 5. Stratigraphy within this package forms open folds that are aligned parallel to the thrusts and plunge gently to the southeast. Several high angle faults, which parallel the general structural trend, are inferred on the property and others could be present. One or more of these faults may have acted as a conduit for mineralizing fluids.

The **Bouvette Formation** is the most abundant inferred rock type shown on government based maps and is the principal focus of ATAC's exploration. It can be divided into three main units which young to the northeast. In order from oldest to youngest:

- 1) **Cambrian and Ordovician** – massive pale grey dolostone, oncolitic dolostone, minor quartzite and sandy dolostone.
- 2) **Ordovician and/or Silurian** – thin to medium bedded grey and buff weathering silty limestone; massive white limestone, well bedded tan and grey limestone in the upper part of the unit.
- 3) **Silurian and Devonian** – thick bedded to massive light grey dolostone and limestone. Dark grey, fetid limestone containing “two hole” and “star” crinoids at the top of the unit.

The thickness of the Bouvette Formation on the property is estimated to be at least 1,400 m. The primary focus of mapping to date has been limited to the area around Monument Hill and the Tiger Zone within the Ordovician-Silurian strata hosting carbonate gold replacement mineralization. Elsewhere the Bouvette Formation has not been mapped in detail and remains undifferentiated.

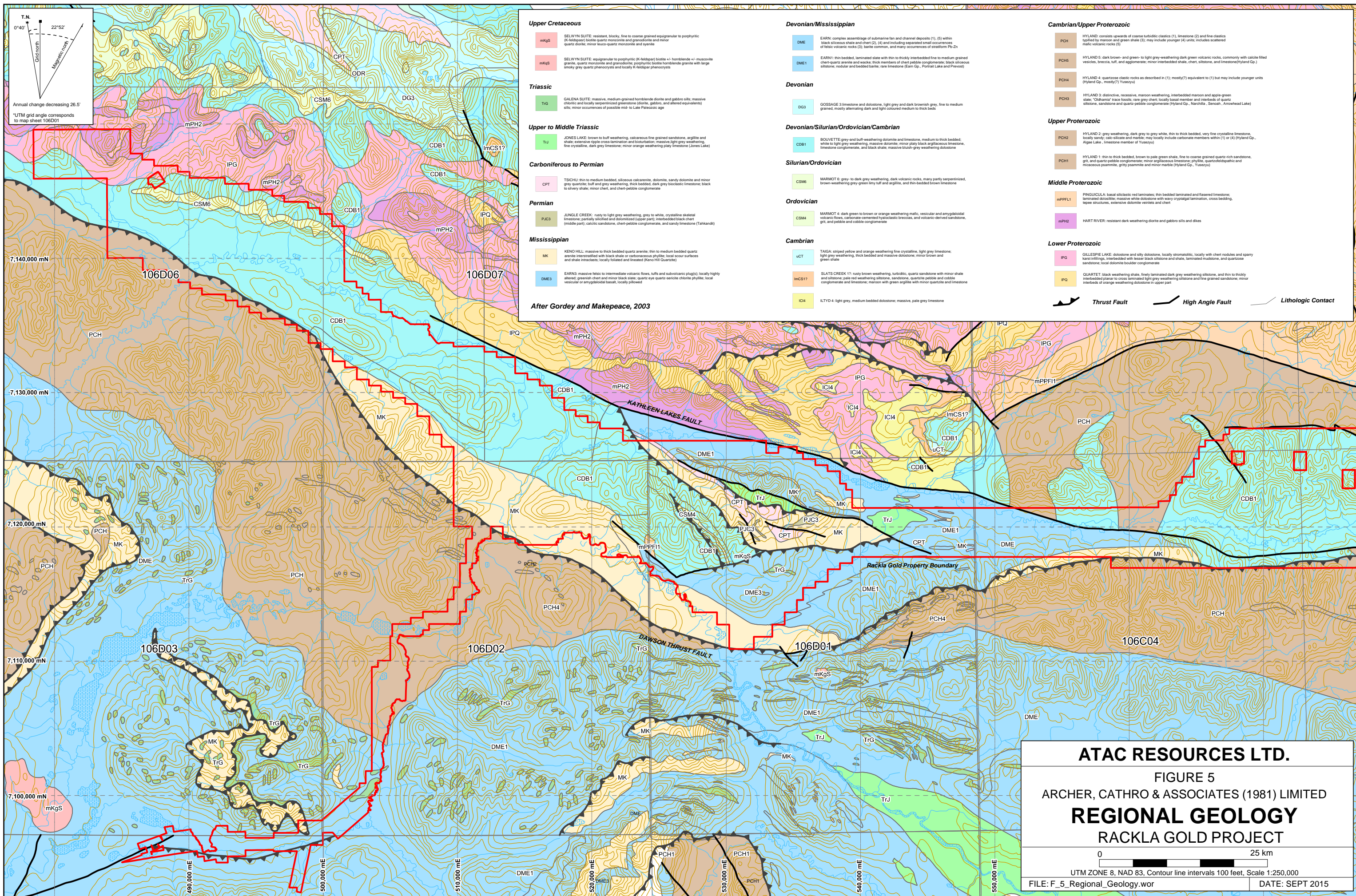

Upper Cretaceous

- mKqS SELWYN SUITE: resistant, blocky, fine to coarse grained equigranular to porphyritic (K-feldspar) biotite quartz monzonite and granodiorite and minor quartz diorite; minor leuco-quartz monzonite and syenite
- mKqS SELWYN SUITE: equigranular to porphyritic (K-feldspar) biotite +/- hornblende +/- muscovite granite, quartz monzonite and granodiorite; porphyritic biotite hornblende granite with large smoky grey quartz phenocrysts and locally K-feldspar phenocrysts

Triassic

- TRG GALENA SUITE: massive, medium-grained hornblende diorite and gabbro sills; massive chertic and locally serpentinized greenstone (diorite, gabbro, and altered equivalents) sills; minor occurrences of possible mid-to Late Paleozoic age

Upper to Middle Triassic

- TrJ JONES LAKE: brown to buff weathering, calcareous fine grained sandstone, argillite and shale; extensive ripple cross-lamination and boturbation; massive light grey weathering, fine crystalline, dark grey limestone; minor orange weathering platy limestone (Lonest Lake)

Carboniferous to Permian

- CPT TSICHU: thin to medium bedded, siliceous calcarenite, dolomite, sandy dolomite and minor grey quartzite; buff and grey weathering, thick bedded, dark grey bioclastic limestone; black to silvery shale; minor chert, and chert-pebble conglomerate

Permian

- PJC3 JUNGLE CREEK: rusty to light grey weathering, grey to white, crystalline skeletal limestone; partially silicified and dolomitized (upper part); interbedded black chert (middle part); calcic sandstone, chert-pebble conglomerate, and sandy limestone (Tahkandi)

Mississippian

- MK KENO HILL: massive to thick bedded quartz arenite; thin to medium bedded quartz arenite interstratified with black shale or carbonaceous phyllite; local scour surfaces and shale intertastics; locally foliated and lineated (Keno Hill Quartzite)
- DME3 EARN: massive felsic to intermediate volcanic flows, tuffs and subvolcanic plugs(s); locally highly altered; greenish chert and minor black slate; quartz eye quartz-syenite diorite phyllite; local vesicular or amygdaloidal basalt, locally pillowed

Devonian/Mississippian

- DME EARN: complex assemblage of submarine fan and channel deposits (1), (5) within black siliceous shale and chert (2), (4) and including separated small occurrences of felsic volcanic rocks (3); basalt common, and many occurrences of stratiform Pb-Zn
- DME1 EARN1: thin bedded, laminated slate with thin to thickly interbedded fine to medium grained chert-quartz arenite and massive, thick members of chert-pebble conglomerate; black siliceous siltstone; nodular and bedded barite; rare limestone (Eam Gp., Portrait Lake and Prevost)

Devonian

- DG3 GOSSAGE 3: limestone and dolomite, light grey and dark brownish grey, fine to medium grained, mostly alternating dark and light colored medium to thick beds

Devonian/Silurian/Ordovician/Cambrian

- CDB1 BOUVETTE: grey and buff-weathering dolomite and limestone, medium to thick bedded; white to light grey weathering, massive dolomite; minor grey black argillaceous limestone, limestone conglomerate, and black shale; massive bluish-grey weathering dolostone

Silurian/Ordovician

- CSM6 MARMOT 6: grey to dark grey weathering, dark volcanic rocks, many partly serpentinized, brown-weathering grey-green tiny tuff and argillite, and thin bedded brown limestone

Ordovician

- CSM4 MARMOT 4: dark green to brown or orange weathering mafic, vesicular and amygdaloidal volcanic flows, carbonate cemented hyaloclastic breccias, and volcanic-derived sandstone, grit, and pebble and cobble conglomerate

Cambrian

- UCT TAGA: striped yellow and orange weathering fine crystalline, light grey limestone; light grey weathering, thick bedded and massive dolostone; minor brown and green shale
- ICS17 SLATS CREEK 17: rusty brown weathering, turbiditic, quartz sandstone with minor shale and siltstone; pale red weathering siltstone, sandstone, quartz pebble and cobble conglomerate and limestone; maroon with green argillite with minor quartzite and limestone
- IC4 ILTYD 4: light grey, medium bedded dolostone; massive, pale grey limestone

Cambrian/Upper Proterozoic

- PCH1 HYLAND: consists upwards of coarse turbiditic clastics (1), limestone (2) and fine clastics typified by maroon and green shale (3); may include younger (4) units; includes scattered mafic volcanic rocks (5)
- PCH5 HYLAND 5: dark brown- and green- to light grey-weathering dark green volcanic rocks, commonly with calcite filled vesicles, breccia, tuff, and agglomerate; minor interbedded shale, siltstone, and limestone (Hyland Gp.)
- PCH4 HYLAND 4: quartzose clastic rocks as described in (1), mostly(?) equivalent to (1) but may include younger units (Hyland Gp., mostly(?) Yuseyu)
- PCH3 HYLAND 3: distinctive, recessive, maroon weathering, interbedded maroon and apple-green silt; "Ochreum" trace fossil; rare grey chert; locally basal member and interbeds of quartz siltstone, sandstone and quartz-pebble conglomerate (Hyland Gp., Narchilla, Senoah, Antiohead Lake)

Upper Proterozoic

- PCH2 HYLAND 2: grey weathering, dark grey to grey white, thin to thick bedded, very fine crystalline limestone, locally sandy; calc-silicates and marble; may locally include carbonate members within (1) or (4) (Hyland Gp., Algae Lake, limestone member of Yuseyu)
- PCH1 HYLAND 1: thin to thick bedded, brown to pale green shale, fine to coarse grained quartz-rich sandstone, grit, and quartz-pebble conglomerate; minor argillaceous limestone; phyllite, quartzofeldspathic and micaceous psammite, gritty psammite and minor marble (Hyland Gp., Yuseyu)

Middle Proterozoic

- mPPF11 PINGULICULA: basal siliclastic red laminates; thin bedded laminated and fissured limestone; laminated dolostone; massive white dolostone with wavy crystallographic lamination, cross bedding, lense structures, extensive dolomite vugs and chert
- mPH2 HART RIVER: resistant dark weathering diorite and gabbro sills and dikes

Lower Proterozoic

- IPG GILLESPIE LAKE: dolostone and silty dolostone, locally stromatolitic, locally with chert nodules and sparry karst fillings; interbedded with lesser black siltstone and shale, laminated mudstone, and quartzose sandstone; local dolomite boulder conglomerate
- IPQ QUARTET: black weathering shale, finely laminated dark grey weathering siltstone, and thin to thickly interbedded clay to cross-laminated light grey weathering siltstone and fine grained sandstone; minor interbeds of orange weathering dolostone in upper part



ATAC RESOURCES LTD.

FIGURE 5
ARCHER, CATHRO & ASSOCIATES (1981) LIMITED
REGIONAL GEOLOGY
RACKLA GOLD PROJECT

0 25 km

UTM ZONE 8, NAD 83, Contour line intervals 100 feet, Scale 1:250,000

FILE: F_5_Regional_Geology.wor DATE: SEPT 2015

A narrow sliver of Middle Proterozoic **Fifteen Mile Group** dolostone lies beneath the Bouvette Formation, to the southwest. This unit is composed of chocolate to orange brown weathering, cryptalgal laminated, medium to thick bedded dolostone, overlain by rusty brown weathering, olive green siltstone and shale with lesser maroon black and buff shale.

The **Marmot Formation** consists of thin volcanoclastic horizons that are interbedded with the Ordovician and/or Silurian Bouvette Formation. The horizons range from a few metres to about 20 m thick and comprise dark green to brown weathering mafic, vesicular volcanic flows, carbonate-cemented hyaloclastic breccias and volcanic-derived sandstone, grit and pebble and cobble conglomerate. Locally these horizons are magnetic. Although the Marmot Formation is volumetrically insignificant, it appears to have played an important role in localizing mineralization in the underlying carbonate by acting as an impermeable cap.

Devonian and Mississippian **Earn Group** is located in the southern half of the property and bounds the Bouvette Formation to the south, east and north. This unit is generally recessive weathering and is mostly composed of black shale and chert. To the south a high angle normal fault places Earn Group against Bouvette Formation, while a thrust fault marks the southeastern contact. To the north, the Earn Group conformably lies above Cambrian to Permian shale and limestone, which has been placed against the Bouvette Formation by another high angle fault.

The central part of the property hosts numerous dykes and sills believed to represent a roughly 1000 m diameter granitic plug referred to as the "**Rackla Pluton**". The plug is mostly composed of coarse grained, equigranular, biotite-and muscovite-bearing granite that is locally miarolitic (Panton 2008). The dykes and sills typically range between 30 cm and 7 m in thickness. They are often more fractionated than the plug and include garnet bearing aplite and coarse pegmatite that locally features beryl, amazonite (a green variety of feldspar) and one or more tourmaline minerals (rubellite, indigolite and schorl). The pegmatite bodies comprise mainly orthoclase and quartz but often exhibit abundant lithium-and vanadium-rich micas on their margins.

On surface, the Rackla Pluton is mostly covered by glacial till and only aplite and pegmatite sills and dykes are visible. The pluton is best delineated by its airborne magnetic. At the property scale the pluton is represented by a strong magnetic high. When the data is collapsed to the area immediately surrounding the pluton and a high-pass filter is applied, the signature shows a core magnetic low with a fringing magnetic high.

Analysis of several small bodies of granitic aplite and pegmatite have yielded $40\text{Ar}/39\text{Ar}$ muscovite ages of 62.3 ± 0.7 Ma, 62.4 ± 1.8 Ma and 59.1 ± 2.0 Ma (Kingston, 2009 and Kingston et al., 2010). Based on this data and the composition of the intrusion, Kingston concludes that the Rackla Pluton does not likely belong to the McQuesten Suite (65.2 ± 2.0 Ma).

Skarn and minor hornfels are developed locally within the Bouvette Formation proximal to the intrusions. Skarn grades from distal tremolite-rich (iron-deficient) facies, which are most abundant near the Flat Top Showing (about 1000 m northwest of the pluton), to proximal

actinolite-diopside ± garnet ± pyrrhotite (iron-rich) facies, which are found closer to the pluton and on the margins of some dykes and sills. Massive skarns are mostly developed at contacts between limestone and volcanoclastic horizons. Hornfels is restricted to thin volcanoclastic layers within the Marmot Formation. It is normally rusty weathering and often contains disseminated to semi-massive pyrrhotite. Limestone and dolomite are locally altered to marble and often contain disseminated, light grey scapolite crystals. The scapolite is difficult to recognize on freshly broken surfaces but stands out on weathered surfaces as prismatic randomly orientated crystals.

MINERALIZATION

Several types of mineralization are known to occur on the Rau Trend including: **1)** sediment-hosted replacement-style gold; **2)** zinc±silver±lead±gold±bismuth in limonite-rich veins and replacement bodies; **3)** scheelite in tremolite skarns; **4)** pyrrhotite±scheelite±chalcopyrite in actinolite-diopside±garnet skarns; **5)** wolframite± tantalite in granite; **6)** gold bearing quartz-boulangerite veins; and **7)** iron±zinc in hydromorphically transported gossans.

Replacement-style gold mineralization, similar to that of the Tiger Deposit, was the primary focus of prospecting in 2014. To date several replacement-style gold showings have been identified along the Rau Trend, with the Tiger Zone being the best understood and most aggressively explored.

Gold mineralization at the Tiger Zone Gold occurs in both sulphide and oxide facies mineralization. Sulphide mineralization is accompanied by, and developed within, limestone which is replaced by ferruginous dolomite and iron carbonate minerals. Sulphide species consist of disseminated to banded pyrite, with subordinate arsenopyrite and pyrrhotite and minor bismuthinite and sphalerite. Small amounts of disseminated scheelite are also present. The main sulphide minerals exhibit at least three stages of mineralization. The best intersection from sulphide bearing mineralization averaged 4.04 g/t gold over 96.01 m from hole Rau-09-66.

Oxide mineralization is completely devoid of sulphide minerals and ranges from very competent, weakly porous limonitic mud to rubbly porous limonitic grit. The oxide appears texturally amorphous within most intersections but occasionally exhibits residual color banding that may represent relict sulphide textures. Complete oxidation extends up to 150 m from surface. The best oxide grades (e.g. hole Rau-09-19 which assayed 24.07 g/t gold across 28.04 m) and deepest oxidation occur where northerly trending extensional faults intersect the regional structure. The nature of the contacts between the oxide and sulphide facies is poorly understood, as is the gold distribution within the mineralized horizon and within individual sulphide species.

Mineralization at the Tiger Zone remains open to extension along strike and down dip at both ends of the known zone, as well as at depth across a normal fault that locally defines the southwest margin of the favourable structural corridor.

The **Puma Showing** occurs 4.3 km northwest of the Tiger Deposit and has a geochemical signature similar to Tiger in terms of size and gold and pathfinder elements elevations. Work at

Puma in previous years focused around a prominent fault cutting a dolostone package which contained gold bearing oxide material. In 2009, six goethite or goethite-rich limonite samples returned gold values greater than 1.0 g/t including a peak value of 18.45 g/t gold; while four samples returned silver in excess of 100 g/t to a maximum of 241 g/t silver. This fault, thought to be controlling the mineralization, was tested in two holes - PM-11-01 and PM-11-02. Both holes intersected creamy dolomite cut by a strongly oxidized but healed fault. The best result from this drilling returned 3.9 m of 0.75 g/t Au in PM-11-02.

Detailed mapping of the Puma target was performed in 2013. This work identified the same limestone, dolostone and volcanoclastic units that occur at the Tiger Deposit and noted two distinct generations of faults. The first fault generation shows a northerly orientation which in plan view sinisterly displaces the dolostone-volcanoclastic contact. The second generation, informally referred to as the Puma fault, has a west-northwesterly orientation which dextrally displaces the dolostone-volcanoclastic contact.

ROCK GEOCHEMISTRY

A total of 23 rock samples were collected at the Puma Showing between August 3 to 5 (Figure 6). Samples were sent to ALS Chemex in North Vancouver, B.C. where they were fine crushed before a 250 g split was pulverized to better than 85% passing 75 microns. Splits of the pulverized fraction were routinely dissolved in aqua regia and analyzed for 48 elements using inductively coupled plasma (ICP) together with mass spectroscopy (MS) or atomic emission spectroscopy (AES). The samples were also routinely assayed for gold by Au-AA26, which takes a 50 g charge and prepares it by fire assay before being finished by atomic absorption spectroscopy. Samples collected at Puma in 2014 returned values ranging from below detection limit (<0.01) to a maximum value of 4.21 g/t Au (Figure 7). The mineralized rock samples support the hypothesis that the gold at the Puma target is sourcing from Puma fault. Appendix III contains rock sample descriptions and Appendix IV contains certificates of analysis from the 2014 program.

SOIL GEOCHEMISTRY

In 2014, crews performed grid and contour sampling along the previously unsampled portion of the Rackla Gold Project, 21 to 55 km east of the Tiger Deposit. Soil sample locations are shown on Figures 8 to 11, while results for arsenic are shown thematically on Figures 12 to 15. The samples were transported from the property to Whitehorse in the custody of Archer Cathro employees. From there, they were shipped to ALS Chemex in North Vancouver. At the lab, soil samples were dried and screened to -35 mesh to produce a fine fraction, which was then pulverized to 85% passing 75 microns. Splits of the pulverized fraction were routinely dissolved in aqua regia and analyzed for 35 elements using the ICP-AES technique (ME-ICP41). All samples were also analyzed for gold using fire assay and ICP-AES (Au-ICP21). Certificates of Analysis appear in Appendix IV.

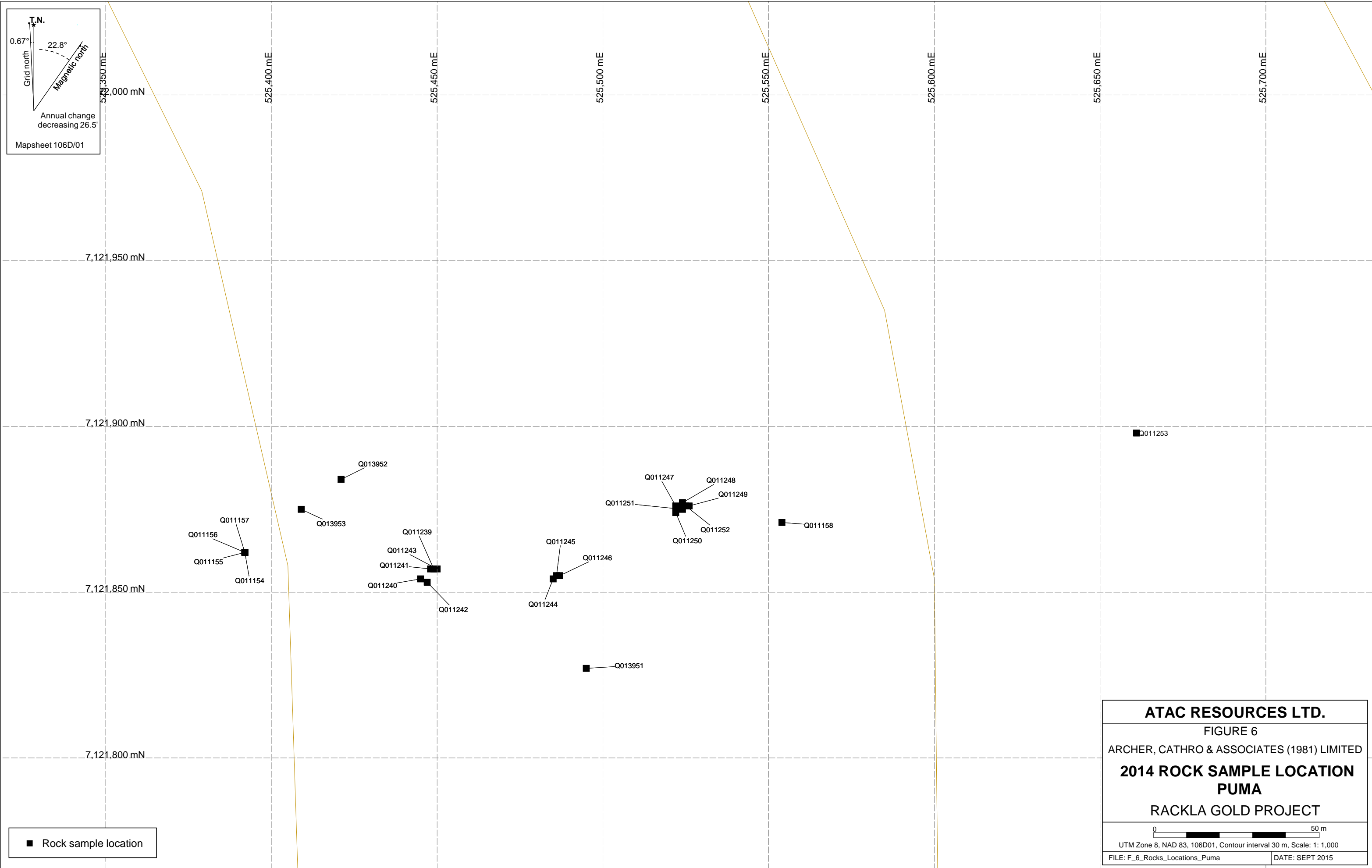

■ Rock sample location

ATAC RESOURCES LTD.
 FIGURE 6
 ARCHER, CATHRO & ASSOCIATES (1981) LIMITED
**2014 ROCK SAMPLE LOCATION
 PUMA**
 RACKLA GOLD PROJECT

0 50 m
 UTM Zone 8, NAD 83, 106D01, Contour interval 30 m, Scale: 1: 1,000
 FILE: F_6_Rocks_Locations_Puma DATE: SEPT 2015

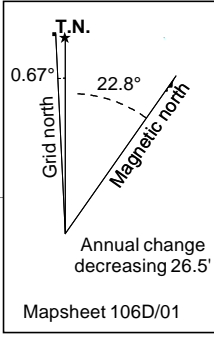
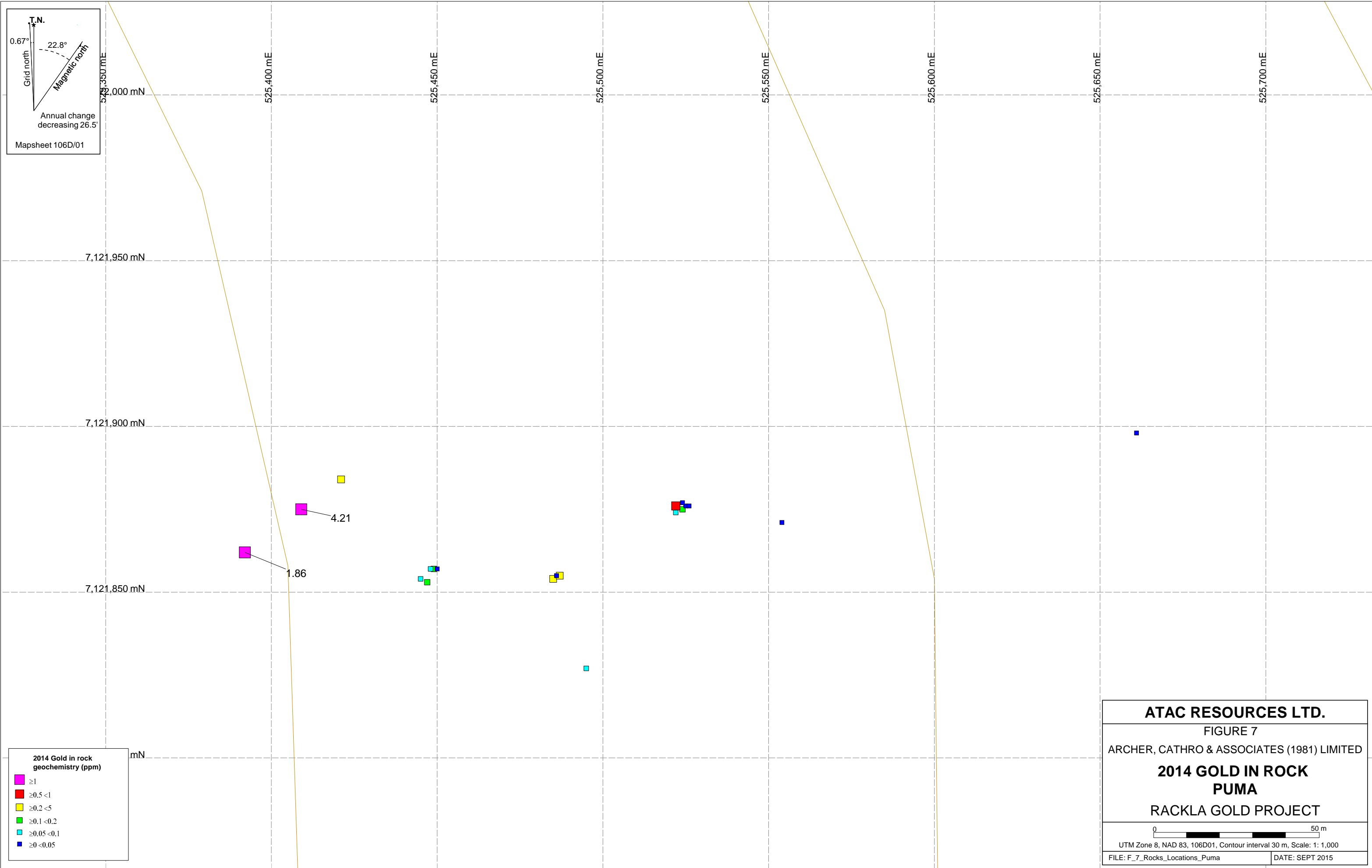

2014 Gold in rock geochemistry (ppm)

■	≥1
■	≥0.5 <1
■	≥0.2 <0.5
■	≥0.1 <0.2
■	≥0.05 <0.1
■	≥0 <0.05

ATAC RESOURCES LTD.
FIGURE 7
 ARCHER, CATHRO & ASSOCIATES (1981) LIMITED
2014 GOLD IN ROCK
PUMA
 RACKLA GOLD PROJECT

0 50 m
 UTM Zone 8, NAD 83, 106D01, Contour interval 30 m, Scale: 1: 1,000
 FILE: F_7_Rocks_Locations_Puma DATE: SEPT 2015

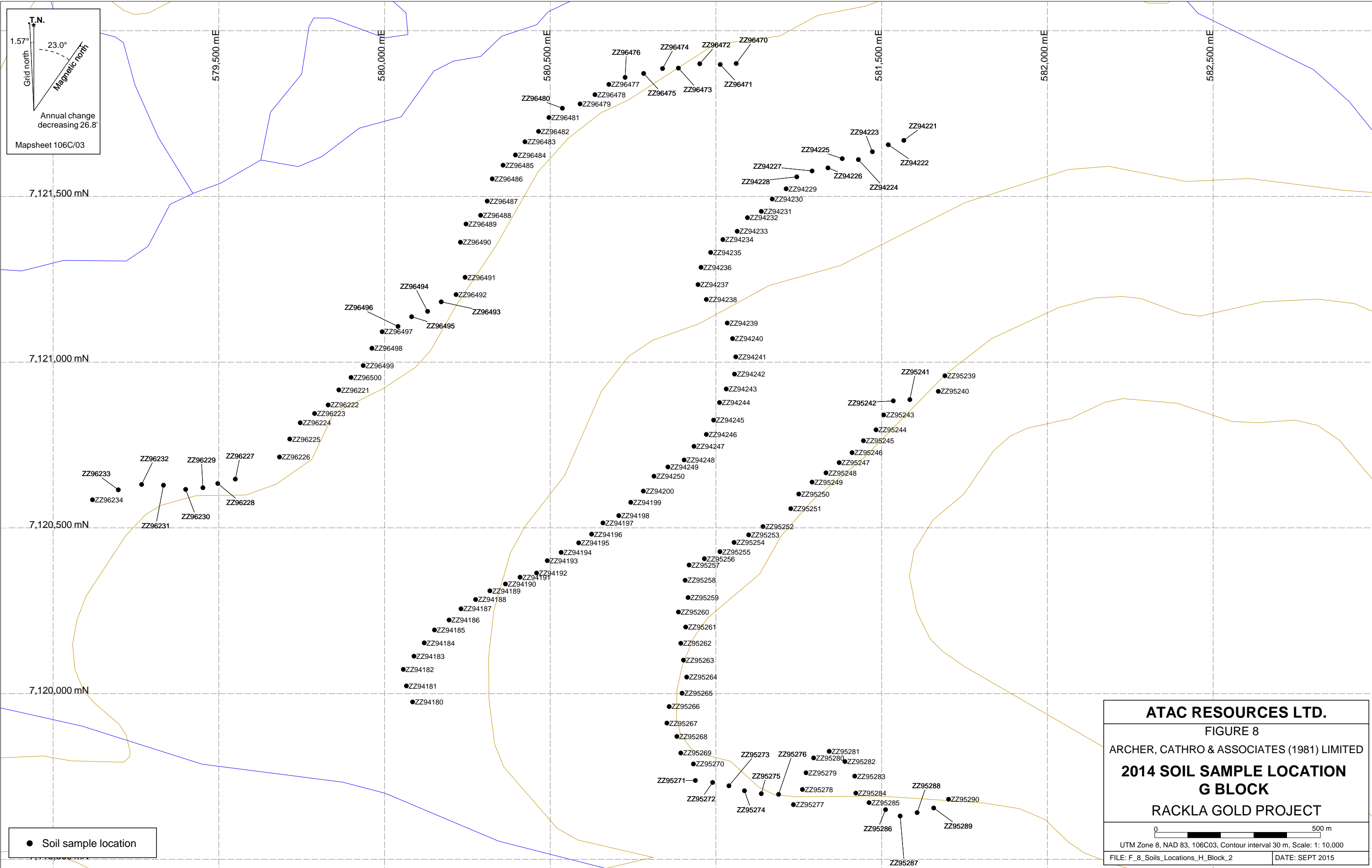

T.N.
 1.57°
 Grid north
 23.0°
 Magnetic north
 Annual change
 decreasing 26.8'
 Mapsheet 106C/03

● Soil sample location

ATAC RESOURCES LTD.
 FIGURE 8
 ARCHER, CATHRO & ASSOCIATES (1981) LIMITED
**2014 SOIL SAMPLE LOCATION
 G BLOCK**
 RACKLA GOLD PROJECT

0 500 m
 UTM Zone 8, NAD 83, 106C03, Contour interval 30 m, Scale: 1: 10,000
 FILE: F_8_Soils_Locations_H_Block_2 DATE: SEPT 2015

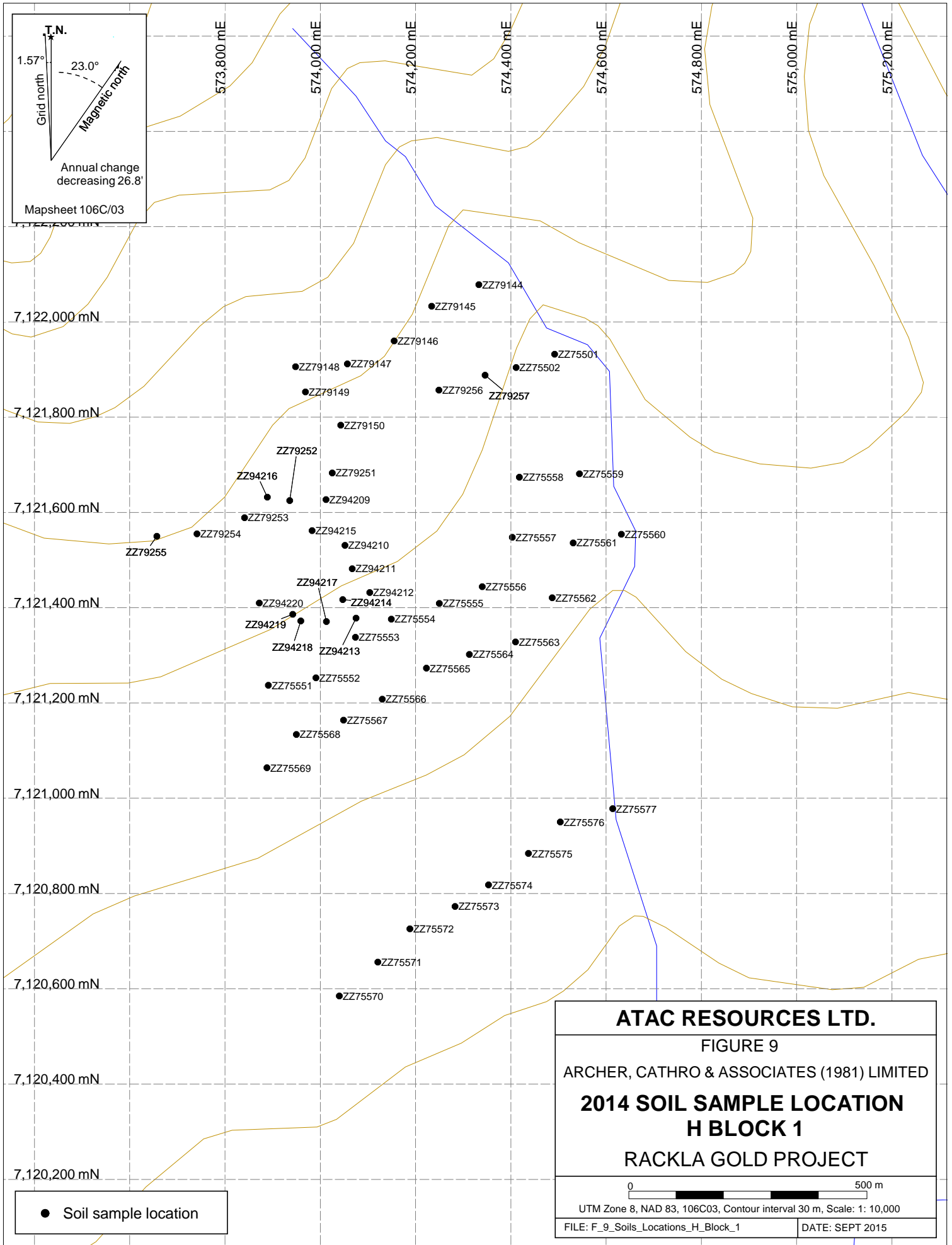

T.N.
 1.57°
 Grid north
 23.0°
 Magnetic north
 Annual change decreasing 26.8'
 Mapsheet 106C/03

ATAC RESOURCES LTD.
 FIGURE 9
 ARCHER, CATHRO & ASSOCIATES (1981) LIMITED
2014 SOIL SAMPLE LOCATION
H BLOCK 1
RACKLA GOLD PROJECT

0 500 m
 UTM Zone 8, NAD 83, 106C03, Contour interval 30 m, Scale: 1: 10,000
 FILE: F_9_Soils_Locations_H_Block_1 DATE: SEPT 2015

● Soil sample location

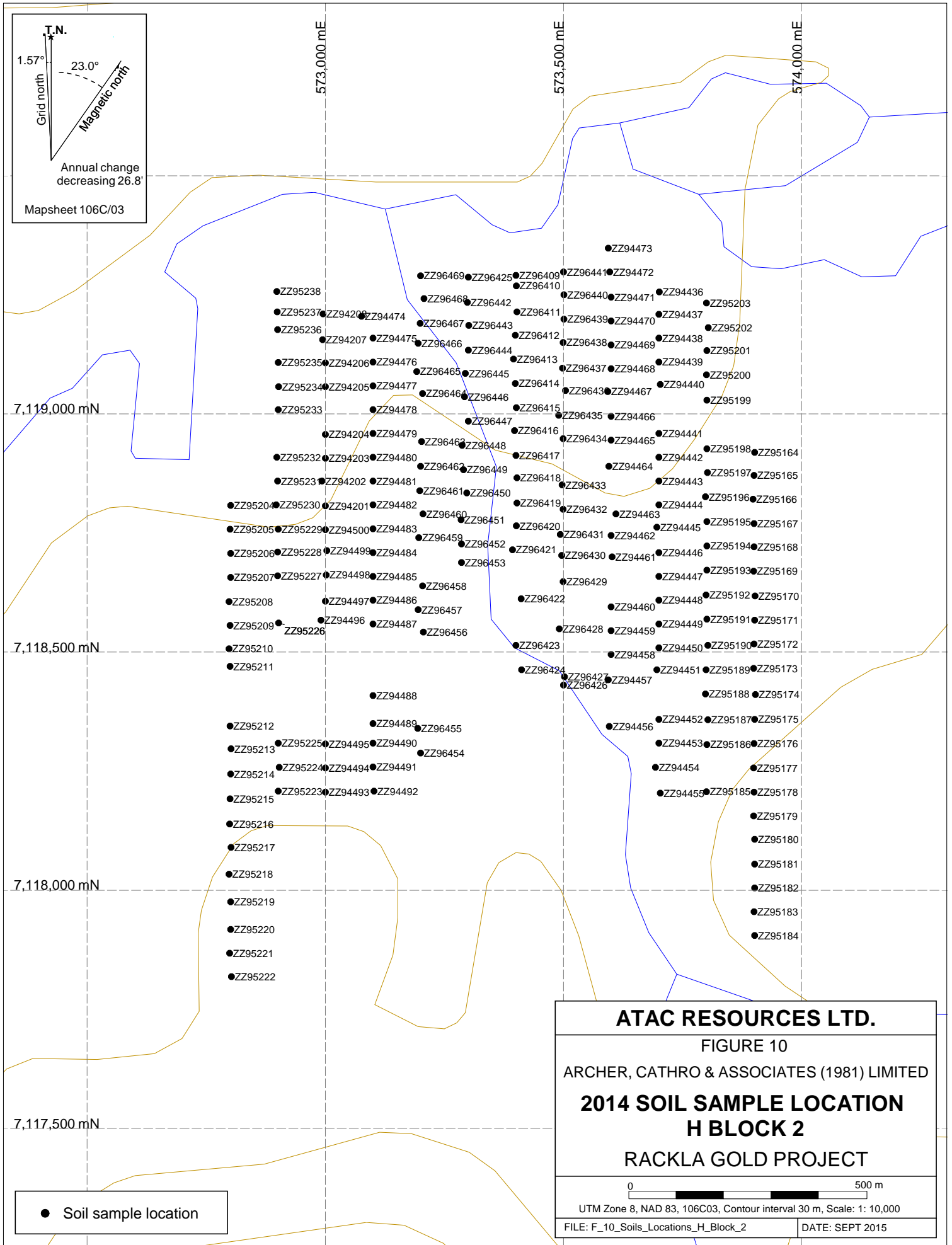
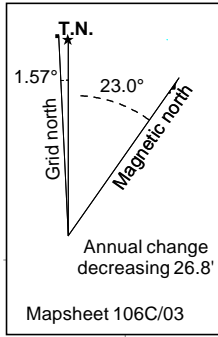

● Soil sample location

ATAC RESOURCES LTD.

FIGURE 10

ARCHER, CATHRO & ASSOCIATES (1981) LIMITED

2014 SOIL SAMPLE LOCATION

H BLOCK 2

RACKLA GOLD PROJECT

0 500 m

UTM Zone 8, NAD 83, 106C03, Contour interval 30 m, Scale: 1: 10,000

FILE: F_10_Soils_Locations_H_Block_2 DATE: SEPT 2015

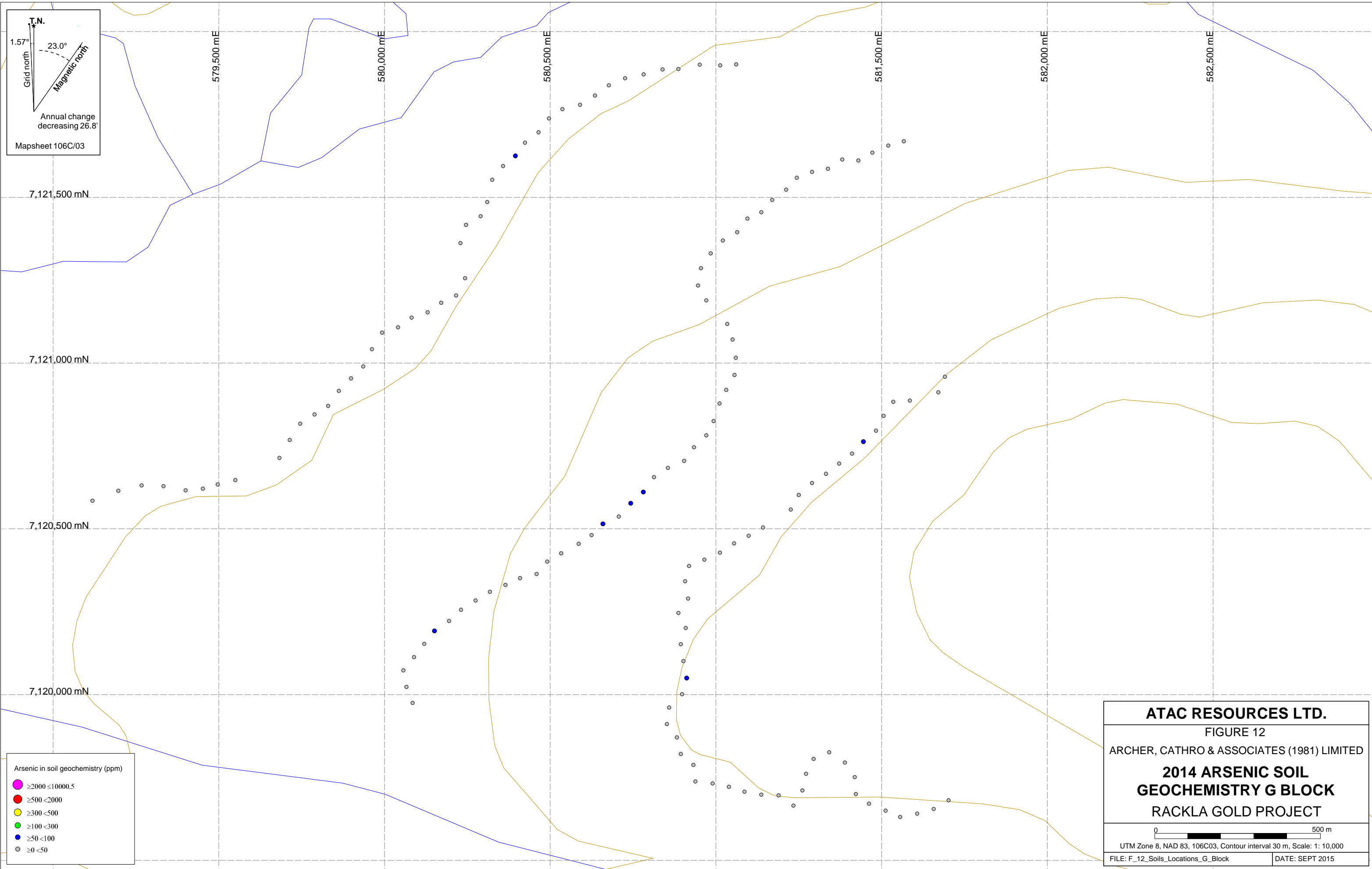

T.N.
 1.57°
 Grid north
 23.0°
 Magnetic north
 Annual change
 decreasing 26.8'
 Mapsheet 106C/03

579,500 mE 580,000 mE 580,500 mE 581,500 mE 582,000 mE 582,500 mE

7,121,500 mN

7,121,000 mN

7,120,500 mN

7,120,000 mN

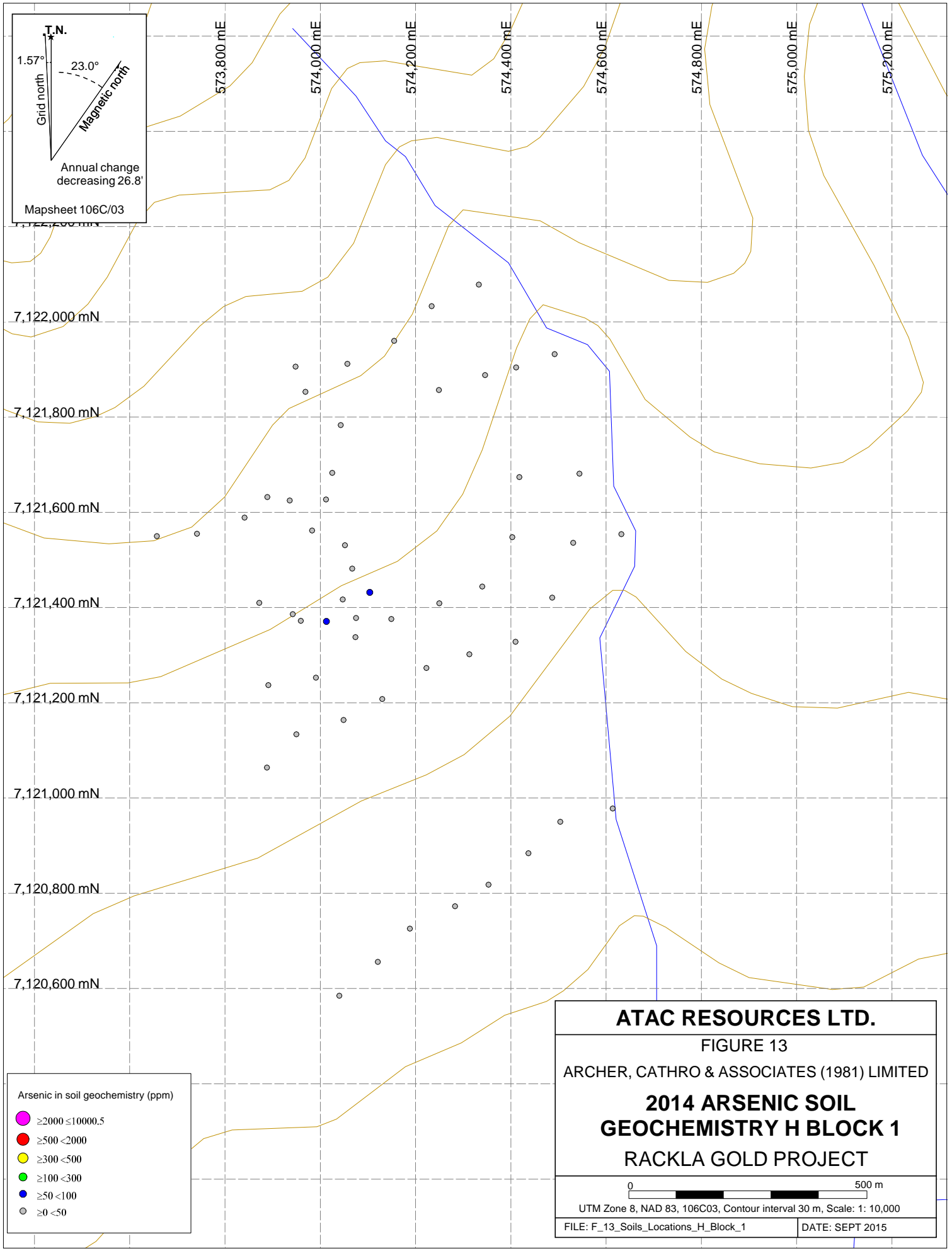

T.N.
 1.57°
 Grid north
 23.0°
 Magnetic north
 Annual change decreasing 26.8'
 Mapsheet 106C/03

7,122,000 mN
 7,121,800 mN
 7,121,600 mN
 7,121,400 mN
 7,121,200 mN
 7,121,000 mN
 7,120,800 mN
 7,120,600 mN

573,800 mE
 574,000 mE
 574,200 mE
 574,400 mE
 574,600 mE
 574,800 mE
 575,000 mE
 575,200 mE

- Arsenic in soil geochemistry (ppm)
- $\geq 2000 \leq 10000.5$
 - $\geq 500 < 2000$
 - $\geq 300 < 500$
 - $\geq 100 < 300$
 - $\geq 50 < 100$
 - $\geq 0 < 50$

ATAC RESOURCES LTD.

FIGURE 13

ARCHER, CATHRO & ASSOCIATES (1981) LIMITED

**2014 ARSENIC SOIL
 GEOCHEMISTRY H BLOCK 1
 RACKLA GOLD PROJECT**

0 500 m

UTM Zone 8, NAD 83, 106C03, Contour interval 30 m, Scale: 1: 10,000

FILE: F_13_Soils_Locations_H_Block_1 DATE: SEPT 2015

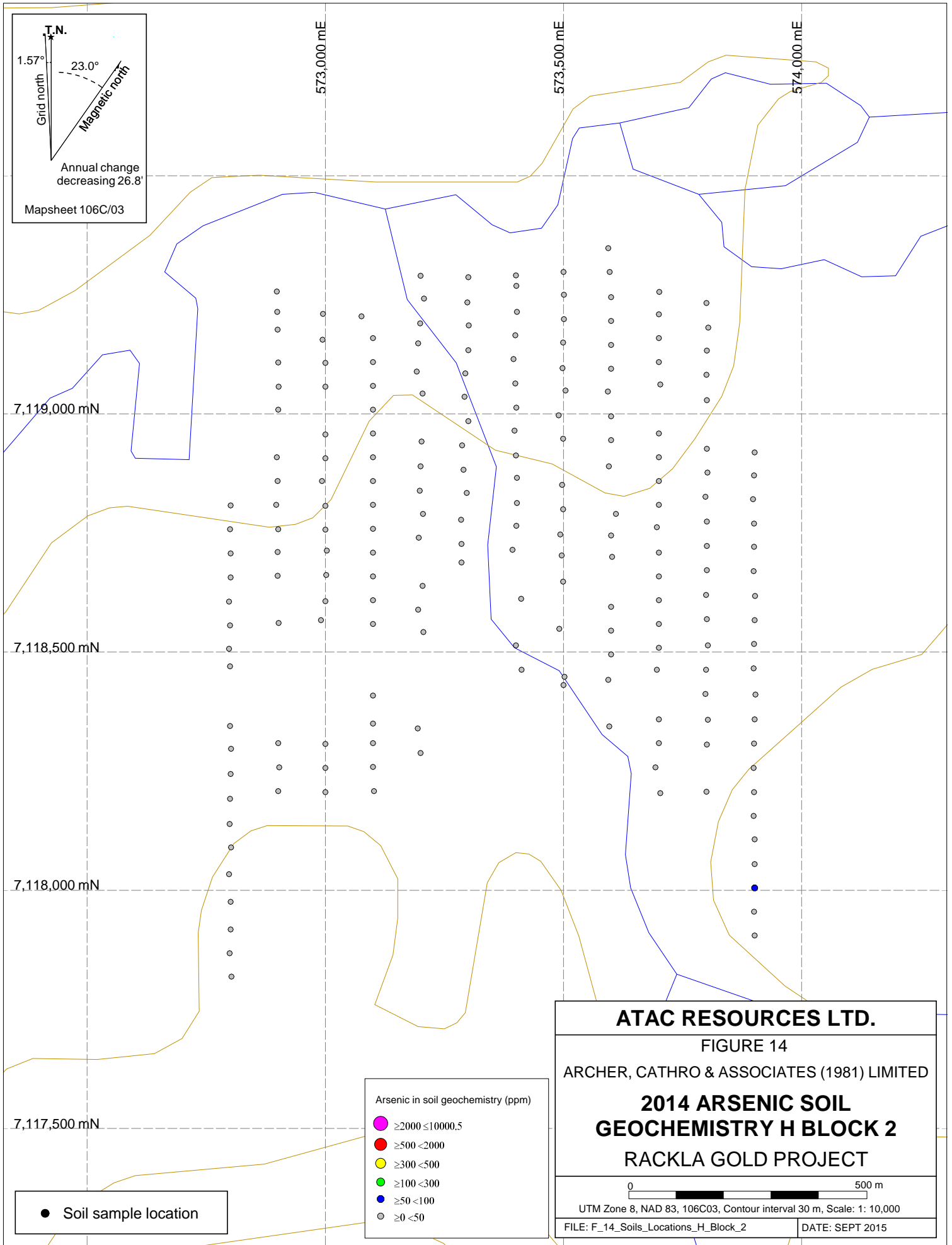
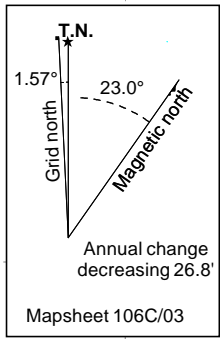

● Soil sample location

Arsenic in soil geochemistry (ppm)

- $\geq 2000 \leq 10000.5$
- $\geq 500 < 2000$
- $\geq 300 < 500$
- $\geq 100 < 300$
- $\geq 50 < 100$
- $\geq 0 < 50$

ATAC RESOURCES LTD.

FIGURE 14

ARCHER, CATHRO & ASSOCIATES (1981) LIMITED

**2014 ARSENIC SOIL
 GEOCHEMISTRY H BLOCK 2
 RACKLA GOLD PROJECT**

0 500 m

UTM Zone 8, NAD 83, 106C03, Contour interval 30 m, Scale: 1: 10,000

FILE: F_14_Soils_Locations_H_Block_2 DATE: SEPT 2015

Thick glacial till covered much of the area sampled which likely explains the subdued response of the soil geochemical sampling program. No significant gold value was returned. Arsenic values ranged from below detection limit to a maximum value of 4310 ppm.

TIGER DEPOSIT PRELIMINARY ECONOMIC ASSESSMENT

In 2014, ATAC completed and released the results of a maiden Preliminary Economic Assessment (PEA) of the Tiger Deposit. In order to accomplish this a preliminary economic model was generated with data from mining and metallurgical studies, evaluations of processing options and plant throughput rates, investigations of site specific environmental factors and regulatory requirements necessary for production and analysis of logistical and infrastructure requirements. The final Preliminary Economic Assessment Report documenting the results of this work occurs in Appendix V.

In summary, the report suggested that the Tiger Deposit be mined as an open pit operation utilizing a conventional truck-and-excavator fleet. The Project's total mine life would be 5 years, including 1 year of pre-stripping followed by 4 years of production. Closure and reclamation activities would take 2 years, with all costs modeled in the first year of closure for purposes of the PEA. Over the 5 year mine life, the pit will produce 2 million tonnes of mineralized material and 11.5 million tonnes of waste rock. The life of mine average diluted gold grade would be 3.72 g/t, and the life of mine stripping ratio is 5.58.

A hybrid processing option was proposed for the oxide ore whereby the fine material is treated in a small Carbon in Leach circuit and the coarse material is treated by conventional heap leaching. Based on the PEA study, the life of mine capital expenditure required for a hybrid process was \$124.9 million including \$93 million for pre-production and \$5.4 million in working capital. The average annual operating cost for the process is \$20.10/t processed and \$7.11/t processed for G&A. The mining cost (not including capitalized pre-production) is \$4.46/t mined. The project is projected to produce 221,400 payable ounces of gold at a total all-in sustaining cash cost (as defined by the World Gold Council less corporate G&A) of \$626/oz. The pre-tax Internal Rate of Return is 30.0%.

DISCUSSION AND CONCLUSIONS

The PEA conducted on the Tiger Deposit shows that the simplicity of the mining and processing methods combined with a modular design approach resulted in an optimized development scenario for this small high grade oxide deposit. The PEA could be enhanced through a series of cost effective measures which including geotechnical studies to that may permit steeper pit slopes and resource expansion and upgrading inferred resources to the indicated category, both accomplished through drilling. Additionally, significant potential exists to increase the resource base and life expectancy of the project through further exploration of the more than six untested satellite oxide gold targets and geochemical anomalies, including the Puma Showing.

Respectfully submitted

ARCHER, CATHRO & ASSOCIATES (1981) LIMITED

A handwritten signature in blue ink, appearing to read 'Julia Lane', written in a cursive style.

J. Lane, P.Geol.

A handwritten signature in blue ink, appearing to read 'R. Phillips', written in a cursive style.

R. Phillips, GIT.

REFERENCES

- Abbott, G.
1990 Geology Map of Mount Westman Map Area (106D/1); Indian and Northern Affairs Canada, Exploration and Geological Services Division, Yukon Region, Open File 1990-1.
- Blusson, S.L.
1978 Regional geological setting of lead-zinc deposits in Selwyn Basin, Yukon; Current Research, Part A, Geological Survey of Canada, Paper 78-1a, pp 77-80.
- Carlyle, L.W.
1989 Assessment Report on the TAF Claims; prepared for Bonventures Ltd.
- Carne, A. and Lane J.
2013 Assessment Report Describing Metallurgical Testing, Wildlife Monitoring, Heritage Evaluation and Water Quality and Climate Monitoring Surveys at the Tiger Project; prepared for ATAC Resources Ltd.
- Cathro, R.J.
1989 Report on Geochemical Sampling at the Now Property, Yukon; prepared for NDU Resources Ltd.
- Cathro, R.C.
2006 Great Mining Camps of Canada 1: The History and Geology of the Keno Hill Silver Camp, Yukon Territory; Geoscience Canada, Vol. 33, No. 3, pp 103-134.
- Cockfield, W.E.
1925 Canada Department of Mines; Summary Report, 1924, Part A; Upper Beaver River Area, May District.
- Colpron, M. and Nelson, J. L.
2011 A digital atlas of terranes for the Northern Cordillera; Yukon Geological Survey and British Columbia Geology Survey, BCGS GeoFile 2011-11
http://www.geology.gov.yk.ca/pdf/CanCord_terranes_2011.pdf
- Churchill, S.
1980 Bluelite Assessment Report; Assessment Report filed on behalf of Prism Joint Venture, p. 20.
- Dewonck, B.
1980 Assessment Report for Dee Claims 1 – 174; prepared for Prism Resources Limited.
- Deklerk, R. and Traynor, S. (compilers)
2005 Yukon MINFILE – a database of mineral occurrences (Mom – 115H060); Available at: <http://data.geology.gov.yk.ca/>

Dumala, M.

- 2008 Assessment Report Describing Prospecting and Diamond Drilling at the Wau Property; prepared for Yankee Hat Minerals Ltd. and ATAC Resources Ltd.
- 2009 Assessment Report Describing Geological Mapping, Prospecting, Soil Geochemistry, Diamond Drilling and Geophysical Surveys at the Rau Property; prepared for ATAC Resources Ltd.
- 2011 Assessment Report Describing Geophysics, Soil Geochemistry and Diamond Drilling at the Rau Property; prepared for ATAC Resources Ltd.
- 2012a Assessment Report Describing Diamond Drilling at the Rau Trend; prepared for ATAC Resources Ltd.
- 2012b Assessment Report Describing Diamond Drilling at the Ocelot Showing; prepared for ATAC Resources Ltd.

Dumala, M. and Lane, J.

- 2010 Assessment Report Describing Geological Mapping, Prospecting, Soil Geochemistry and Diamond Drilling at the Rau Property; prepared for ATAC Resources Ltd.

Eaton, W.D. and Panton, B.

- 2008 Assessment Report Describing Geological Mapping, Prospecting, Soil Geochemistry and Geophysical Surveys at the Rau Property; prepared for ATAC Resources Ltd.

Fingler, J.

- 2005 Private geological report on the McQuesten Property for Alexco Resources Corp; published in Alexco prospectus, available from (http://www.sedar.com/issuers/issuers_en.htm).

Gordey, S.P. and Makepeace, A.J. (compilers)

- 2003 Yukon digital geology, version 2.0; Geological Survey of Canada, Open File 1749 and Yukon Geological Survey, Open File 2003-9 (D).

Green, L.C.

- 1972 Geology of Nash Creek, Larsen and Dawson Map Areas, Yukon Territory; Geological Survey of Canada, Memoir 364, pp 157.

Hilker, R.G.

- 1969 Property Evaluation Report on the Jet Claim Group; Prepared for Mr. P. Verslucce.

- Hornbrook, E.H.W., Friske, P.W.B., Lynch, J.J., McCurdy, M.W., Gross, H., Galletta, A.C. and Durham, C.C.
 1990 National Geochemical Reconnaissance Stream Sediment and Water Geochemical Data, East Central Yukon (106D, parts of 106C, 106E and 106F); GSC Open File 2175.
- Johnson, A. A. and Richardson, J.
 1969a Geological and Geochemical Report on the Beaver A Group and Beaver B Group of Mineral Claims.
 1969b Geochemical Report on the Won "A" Group of Mineral Claims
- Kingston, S.P.
 2009 Nature and Origin of Gold-Rich Carbonate Replacement Deposits at the Rau Occurrence, Central Yukon; A Thesis Submitted in Partial Fulfillment of the Requirements for the Degree of Bachelor of Science (Honours) in the Faculty of Science, University of British Columbia.
- Kingston, S., Mortensen, J., Dumala, M. and Gabites, J.
 2010 Ar-Ar Geochronology and Pb Isotopic Constraints on the Origin of the Rau Gold-Rich Carbonate Replacement Deposit, Central Yukon; In Yukon Exploration and Geology 2009., Yukon Geological Survey, pp 213-222.
- Lane, J.,
 2014 Assessment Report Describing Geological Sampling, Hand Trenching, Prospecting, and Geological Mapping at the Rau Trend; prepared for ATAC Resources Ltd.
- Lane, J., McDivitt, J.A., Phillips, R., and Carne, J.
 2013 Assessment Report Describing Geochemical Sampling, Auger Sampling, Geological Mapping, Diamond Drilling, and Geophysical Surveys at the Rackla Gold Property; prepared for ATAC Resources Ltd.
- Montgomery, J.H and Dewonck B.
 1978 Assessment Report for Dee Claims 1-48; prepared for Prism Resources Limited.
- Montgomery, J.H and Cavey, G.
 1978 Assessment Report for El 1-70 Claims, prepared for Prism Resources Limited.
- Mortensen, J.K., Hart, C.J.R., Murphy, D.C. and Heffernan, S.
 2000 Temporal Evolution of Early and Mid-Cretaceous Magmatism in the Tintina Gold Belt; Concepts, Exploration, and Discoveries, Special Volume 2, British Columbia and Yukon Chamber of Mines, January 2000, pp 49-57.

Panton, B.S.

- 2008 A Deposit Model for Mineralization at the Rau Property, Yukon Territory; A Thesis Submitted in Partial Fulfillment of the Requirements for a Degree of Bachelor of Applied Science in the Faculty of Applied Science, Geological Engineering Program, University of British Columbia.

Prism Joint Venture

- 1979a Assessment Report for Dee Claims 1 – 174; prepared for Prism Resources Limited.
- 1979b Assessment Report for Kathy Claims 1 – 8; prepared for Prism Resources Limited.

Roots, C.

- 1990 Geology of 106D/8 and 106D/7 (East half) Map Areas; Indian and Northern Affairs Canada, Exploration and Geology Services Division, Yukon Region, Open File 1990-3.

Sivertz, G.

- 1979 Assessment Report: Geology of the Silver Hawk Claims; prepared for Prism Resources Limited.
- 1980 Assessment Report: Geology of the Silver Hawk Claims; prepared for Prism Resources Limited.

Stroshein, R.W., Giroux, G.H., and Wengzynowski, W.A.

- 2011 Technical report using national instrument 43-101 guidelines for the preparation of the Tiger Zone mineral resource estimate; prepared for ATAC Resources Ltd.

1.12°
 True North
 22.9°
 Magnetic North
 Annual change decreasing 26.6'
 Mapsheet 106C/04

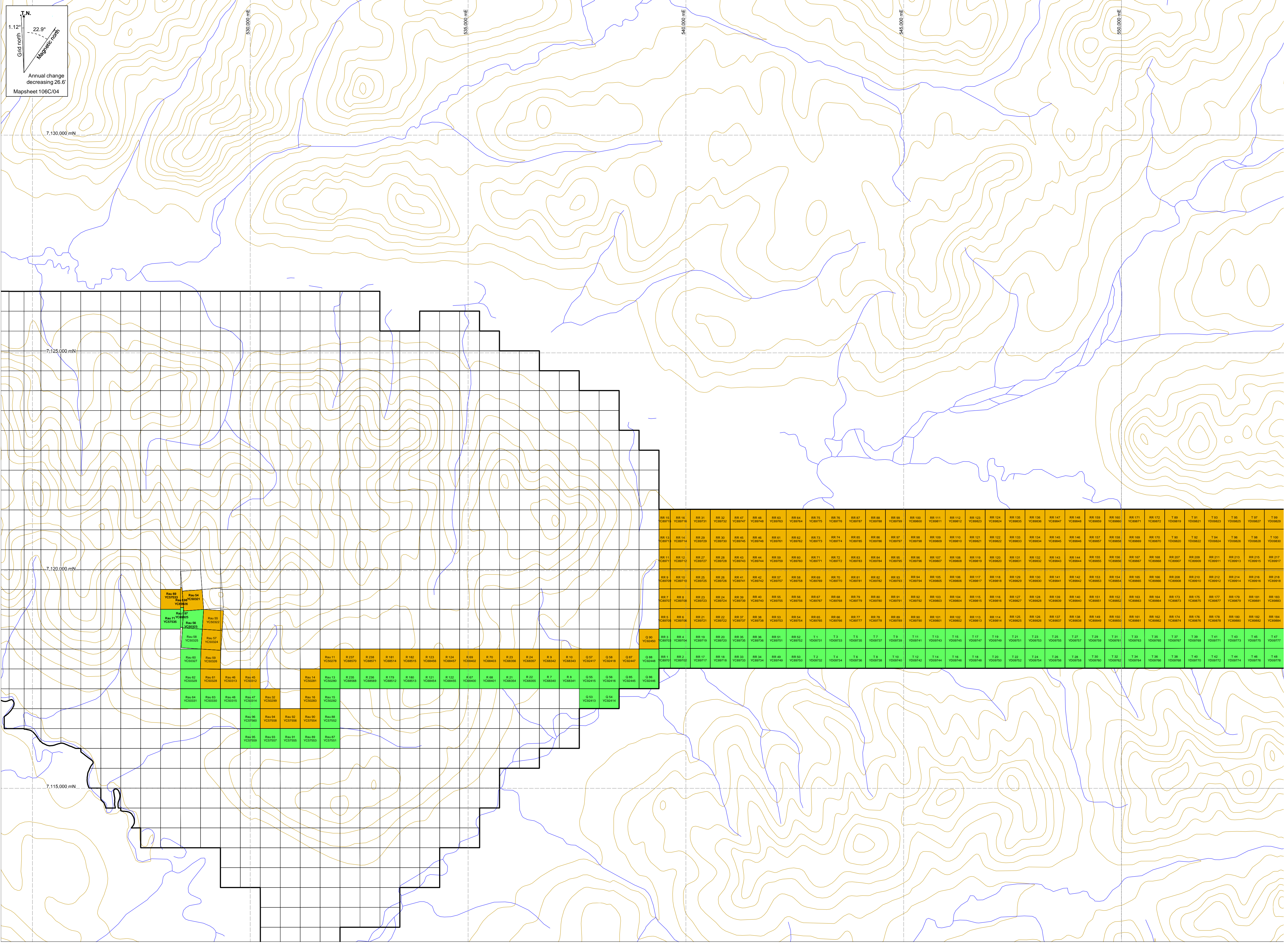

RR 10 YC8974	RR 16 YC8976	RR 31 YC8978	RR 32 YC8979	RR 47 YC8981	RR 48 YC8982	RR 63 YC8984	RR 64 YC8985	RR 75 YC8987	RR 76 YC8988	RR 87 YC8990	RR 88 YC8991	RR 99 YC8993	RR 100 YC8994	RR 111 YC8996	RR 112 YC8997	RR 123 YC8999	RR 124 YC9000	RR 135 YC9002	RR 136 YC9003	RR 147 YC9005	RR 148 YC9006	RR 159 YC9008	RR 160 YC9009	RR 171 YC9011	RR 172 YC9012	T 80 YD9014	T 81 YD9015	T 93 YD9017	T 95 YD9019	T 97 YD9021	T 99 YD9023					
RR 13 YC8975	RR 14 YC8976	RR 29 YC8978	RR 30 YC8979	RR 45 YC8981	RR 46 YC8982	RR 61 YC8984	RR 62 YC8985	RR 73 YC8987	RR 74 YC8988	RR 85 YC8990	RR 86 YC8991	RR 97 YC8993	RR 98 YC8994	RR 109 YC8996	RR 110 YC8997	RR 121 YC8999	RR 122 YC9000	RR 133 YC9002	RR 134 YC9003	RR 145 YC9005	RR 146 YC9006	RR 157 YC9008	RR 158 YC9009	RR 169 YC9011	RR 170 YC9012	T 82 YD9014	T 84 YD9016	T 96 YD9018	T 98 YD9020	T 100 YD9022						
RR 11 YC8972	RR 12 YC8973	RR 27 YC8975	RR 28 YC8976	RR 43 YC8978	RR 44 YC8979	RR 59 YC8981	RR 60 YC8982	RR 71 YC8984	RR 72 YC8985	RR 83 YC8987	RR 84 YC8988	RR 95 YC8990	RR 96 YC8991	RR 107 YC8993	RR 108 YC8994	RR 119 YC8996	RR 120 YC8997	RR 131 YC8999	RR 132 YC9000	RR 143 YC9002	RR 144 YC9003	RR 155 YC9005	RR 156 YC9006	RR 167 YC9008	RR 168 YC9009	RR 207 YC9011	RR 208 YC9012	RR 211 YC9014	RR 213 YC9016	RR 215 YC9018	RR 217 YC9020					
RR 9 YC8970	RR 10 YC8971	RR 25 YC8973	RR 26 YC8974	RR 41 YC8976	RR 42 YC8977	RR 57 YC8979	RR 58 YC8980	RR 69 YC8982	RR 70 YC8983	RR 81 YC8985	RR 82 YC8986	RR 93 YC8988	RR 94 YC8989	RR 105 YC8991	RR 106 YC8992	RR 117 YC8994	RR 118 YC8995	RR 129 YC8997	RR 130 YC8998	RR 141 YC9000	RR 142 YC9001	RR 153 YC9003	RR 154 YC9004	RR 165 YC9006	RR 166 YC9007	RR 209 YC9009	RR 210 YC9010	RR 212 YC9012	RR 214 YC9014	RR 216 YC9016	RR 218 YC9018					
RR 7 YC8978	RR 8 YC8979	RR 23 YC8981	RR 24 YC8982	RR 39 YC8984	RR 40 YC8985	RR 55 YC8987	RR 56 YC8988	RR 67 YC8990	RR 68 YC8991	RR 79 YC8993	RR 80 YC8994	RR 91 YC8996	RR 92 YC8997	RR 103 YC8999	RR 104 YC9000	RR 115 YC9002	RR 116 YC9003	RR 127 YC9005	RR 128 YC9006	RR 139 YC9008	RR 140 YC9009	RR 151 YC9011	RR 152 YC9012	RR 163 YC9014	RR 164 YC9015	RR 175 YC9017	RR 176 YC9018	RR 177 YC9019	RR 179 YC9021	RR 181 YC9023	RR 183 YC9025					
RR 5 YC8976	RR 6 YC8977	RR 21 YC8979	RR 22 YC8980	RR 37 YC8982	RR 38 YC8983	RR 53 YC8985	RR 54 YC8986	RR 65 YC8988	RR 66 YC8989	RR 77 YC8991	RR 78 YC8992	RR 89 YC8994	RR 90 YC8995	RR 101 YC8997	RR 102 YC8998	RR 113 YC8999	RR 114 YC9000	RR 125 YC9002	RR 126 YC9003	RR 137 YC9005	RR 138 YC9006	RR 149 YC9008	RR 150 YC9009	RR 161 YC9011	RR 162 YC9012	RR 174 YC9014	RR 176 YC9016	RR 178 YC9018	RR 180 YC9020	RR 182 YC9022	RR 184 YC9024					
RR 3 YC8974	RR 4 YC8975	RR 19 YC8977	RR 20 YC8978	RR 35 YC8980	RR 36 YC8981	RR 51 YC8983	RR 52 YC8984	T 1 YD8986	T 2 YD8987	T 3 YD8989	T 4 YD8990	T 5 YD8992	T 6 YD8993	T 7 YD8995	T 8 YD8996	T 9 YD8998	T 10 YD8999	T 11 YD9001	T 13 YD9003	T 15 YD9005	T 17 YD9007	T 19 YD9009	T 21 YD9011	T 23 YD9013	T 25 YD9015	T 27 YD9017	T 29 YD9019	T 31 YD9021	T 33 YD9023	T 35 YD9025	T 37 YD9027	T 39 YD9029	T 41 YD9031	T 43 YD9033	T 45 YD9035	T 47 YD9037
RR 1 YC8972	RR 2 YC8973	RR 17 YC8975	RR 18 YC8976	RR 33 YC8978	RR 34 YC8979	RR 49 YC8981	RR 50 YC8982	T 2 YD8984	T 4 YD8986	T 6 YD8988	T 8 YD8990	T 10 YD8992	T 12 YD8994	T 14 YD8996	T 16 YD8998	T 18 YD9000	T 20 YD9002	T 22 YD9004	T 24 YD9006	T 26 YD9008	T 28 YD9010	T 30 YD9012	T 32 YD9014	T 34 YD9016	T 36 YD9018	T 38 YD9020	T 40 YD9022	T 42 YD9024	T 44 YD9026	T 46 YD9028	T 48 YD9030					

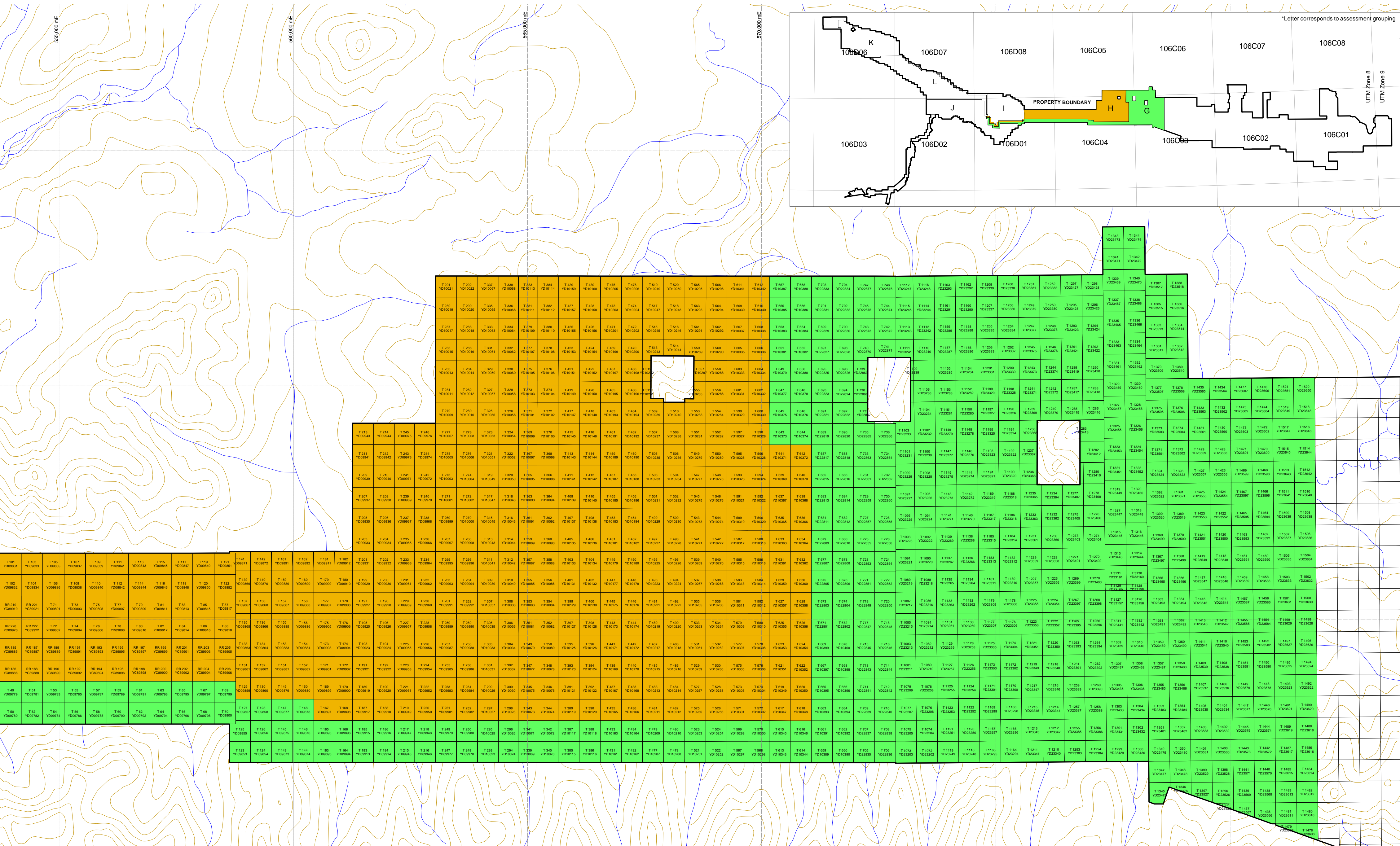
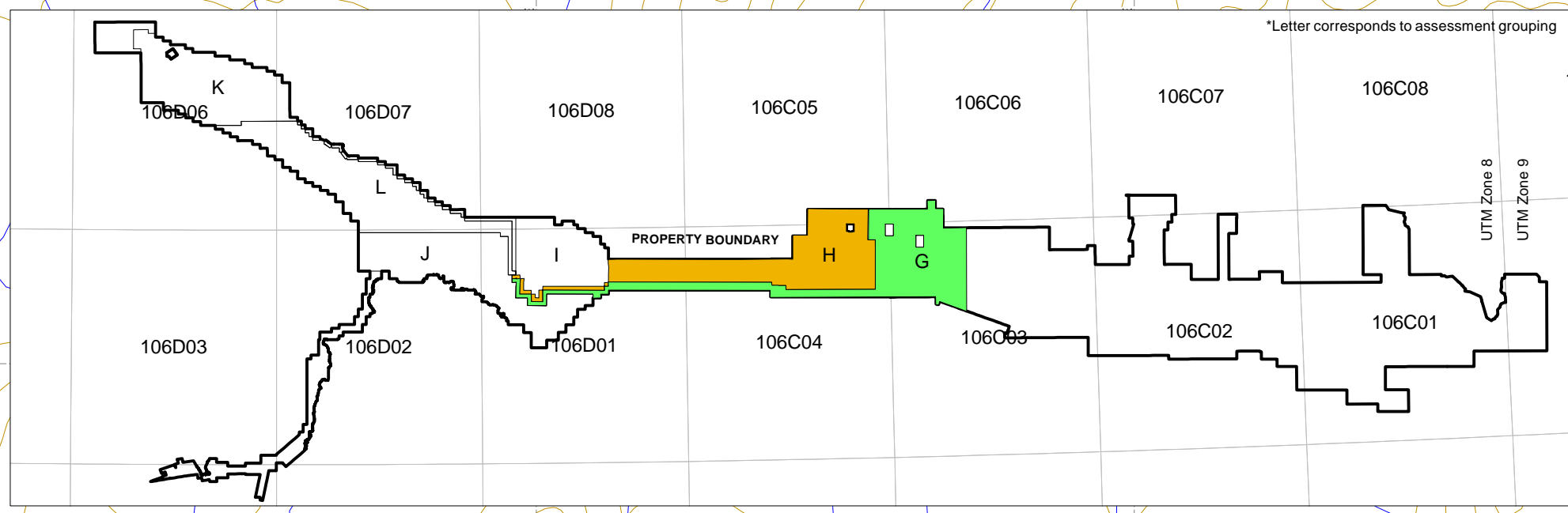

ATAC RESOURCES LTD.

FIGURE 2
 ARCHER, CATHRO & ASSOCIATES (1981) LIMITED
CLAIM LOCATIONS - GROUPS G and H
RACKLA GOLD PROJECT

UTM ZONE 8, NAD 83, 106C04, Contour line intervals 100 feet, Scale 1:50,000

FILE:P:\...Claims_G_H.wor DATE: SEPT 2015

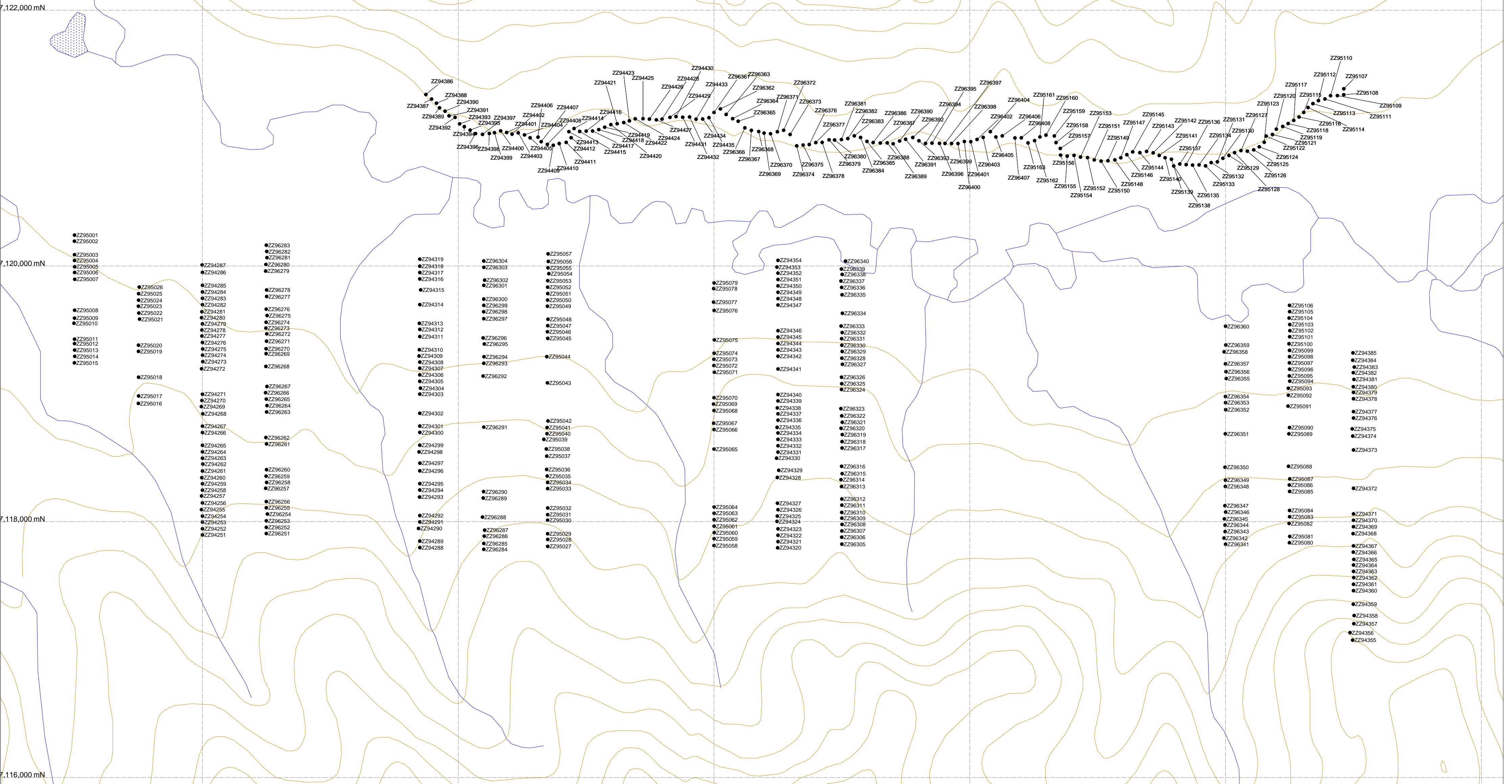
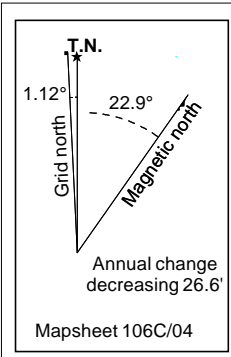

● Soil sample location

ATAK RESOURCES LTD.
 FIGURE 11
 ARCHER, CATHRO & ASSOCIATES (1981) LIMITED
2014 SOIL SAMPLE LOCATION
H BLOCK 3
 RACKLA GOLD PROJECT

0 1 km

UTM Zone 8, NAD 83, 106C03, Contour interval 30 m, Scale: 1: 20,000
 FILE: F_11_Soils_Locations_H_Block_3 DATE: SEPT 2015

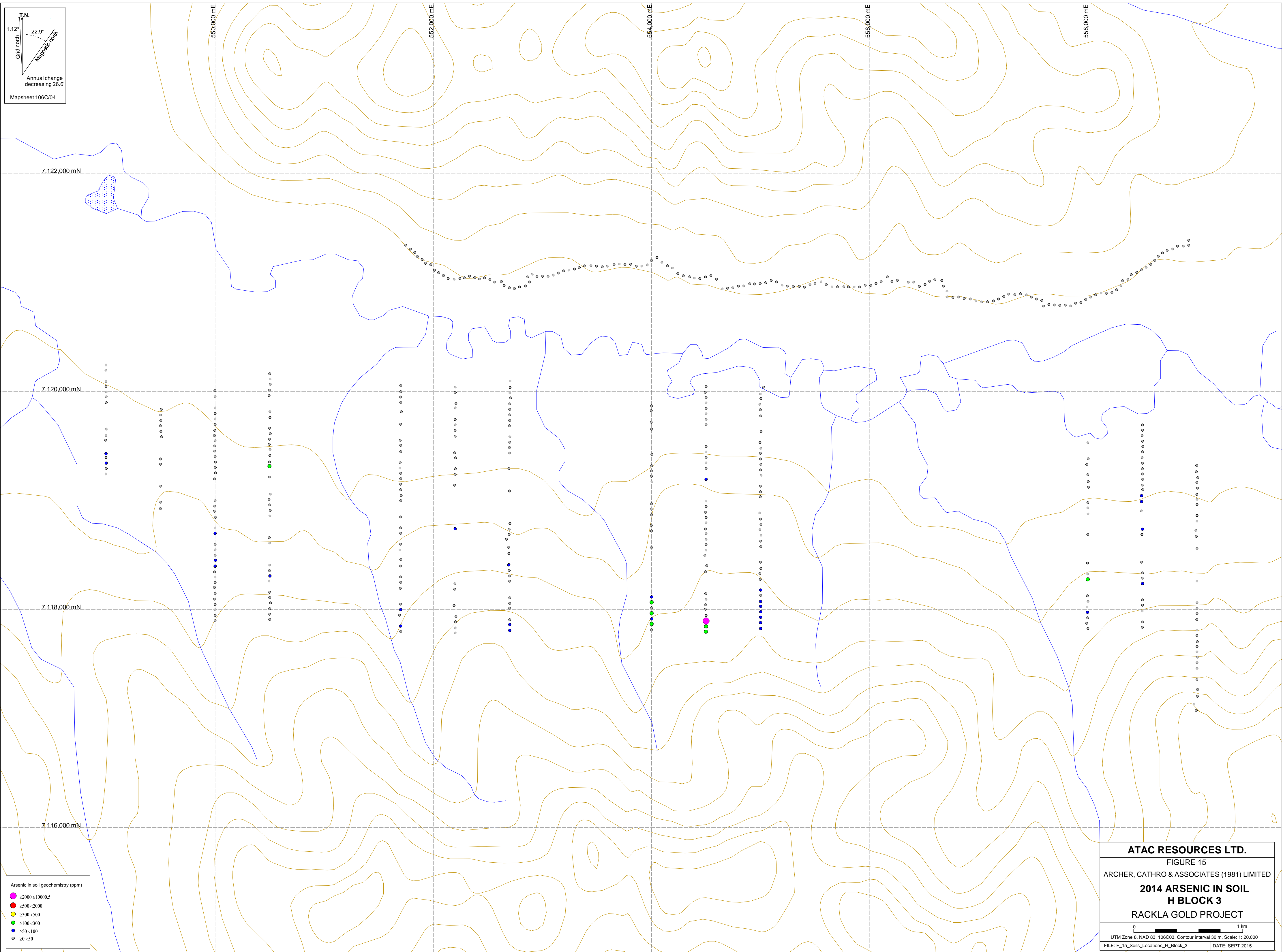
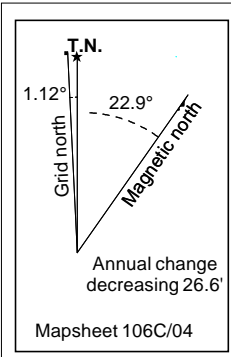

Arsenic in soil geochemistry (ppm)

- ≥2000 ≤10000.5
- ≥500 <2000
- ≥300 <500
- ≥100 <300
- ≥50 <100
- ≥0 <50

ATAC RESOURCES LTD.
FIGURE 15
 ARCHER, CATHRO & ASSOCIATES (1981) LIMITED
2014 ARSENIC IN SOIL
H BLOCK 3
 RACKLA GOLD PROJECT

0 1 km
 UTM Zone 8, NAD 83, 106C03, Contour interval 30 m, Scale: 1: 20,000
 FILE: F_15_Soils_Locations_H_Block_3 DATE: SEPT 2015

APPENDIX I
STATEMENTS OF QUALIFICATIONS

STATEMENT OF QUALIFICATIONS

I, Julia Lane, geologist, with business addresses in Whitehorse, Yukon Territory and Vancouver, British Columbia and residential address in Vancouver, British Columbia, hereby certify that:

1. I graduated from the University of British Columbia in 2008 with a B.Sc. in Earth and Ocean Science.

 2. From 2006 to present, I have been actively engaged in mineral exploration in Yukon Territory, British Columbia and Ontario.

 3. I have been employed with Archer, Cathro & Associates (1981) Limited since 2007 and have been a partner in the company since March 1, 2012.
-
1. I am a Professional Geologist (P.Ge.) with the Association of Professional Engineers and Geoscientists of British Columbia (Licence Number 39441).

 2. I supervised the fieldwork reported herein and have interpreted all data resulting from this work.



J. Lane, P.Ge.

STATEMENT OF QUALIFICATIONS

I, Richard Phillips, geologist, with business addresses in Whitehorse, Yukon Territory and Vancouver, British Columbia and residential address in Vancouver, British Columbia, hereby certify that:

1. I graduated from the University of British Columbia in 2011 with a B.Sc. in Earth and Environmental Science.
2. From 2004 to present, I have been actively engaged in mineral exploration in Yukon Territory and British Columbia.
3. I am a Geoscientist in Training (GIT) with the Association of Professional Engineers and Geoscientists of British Columbia.
4. I have personally participated in the fieldwork reported herein and have interpreted data resulting from this work.



R. Phillips, GIT.

APPENDIX II
STATEMENT OF EXPENDITURES

Statement of Expenditures
Tiger Deposit Rau 54, 56, 69, 71, 97F and 98F
Groups G (745 Mineral Claims) and H (750 Mineral Claims)
February 18, 2015

Labour

R. Carne – geologist - 271 hours at \$145/hr	\$ 41,259.75
D. Eaton – geologist – 3 hours at \$120/hr	378.00
H. Burrell – geologist – 88 hours at \$96/hr	8,870.40
M. Dumala – geologist – 19 1/2 hours at \$96/hr	1,965.60
J. Lane – geologist – 24 hours at \$96/hr	2,419.20
J. Mariacher – office – 44 1/2 hours at \$90/hr	4,205.25
A. Carne – P.Eng. – 387 hours at \$85/hr	34,539.75
J. Itkin – office – 41 1/4 hours at \$85/hr	3,681.56
L. Corbett – expediting – 21 hours at \$81/hr	1,786.05
R. Phillips – geologist – 120 hours at \$77/hr	9,702.00
D. Wallinger – office – 10 hours at \$74/hr	777.00
S. Newman – office -26 1/2 hours at \$62/hr	1,725.15
L. Smith – office - 5 hours at \$62/hr	325.50
J. Thompson-Gladish – field assistant – 88 hours at 55/hr	5,082.00
L. Arnold-Wallinger – field assistant – 88 hours at \$53/hr	<u>4,897.20</u>
	121,614.41

Expenses (including management fee)

Field room and board – 44 days at \$180/day	8,981.28
Dassault Systemes	3,655.51
J. Gibson Environmental Consulting	68,974.73
Golder Associates	25,368.07
Kappes, Cassidy & Associates	208,504.41
KGE Management	15,785.28
Laberge Environmental Services	15,699.42
Resources Strategies	25,254.18
Tetra Tech WEI Inc.	105,671.78
ALS Chemex	27,826.80
Alkan Air	17,474.38
Fireweed Helicopters	<u>73,379.68</u>
	596,575.52

Total \$718,189.93

\$718,189.93/6 claims = \$119,698.32/claim

APPENDIX III
ROCK SAMPLE DESCRIPTIONS

Rock Sample Descriptions

Property: Puma

Sample Number: Q011154 UTM: 525392 mE Nad83, Zone 8
Elevation: 1900 m UTM: 7121862 mN

Comments: Highly altered oxidized volcanics, with Vuggy sandy texture - from RWT-Hp-014

Sample Number: Q011155 UTM: 525392 mE Nad83, Zone 8
Elevation: 1900 m UTM: 7121862 mN

Comments: Limonite, possibly highly altered dolostone or volcanic, original textures destroyed, metallic stringers through out. Brown oxide filling vugs.

Sample Number: Q011156 UTM: 525392 mE Nad83, Zone 8
Elevation: 1900 m UTM: 7121862 mN

Comments: highly altered dolostone or volcanics, brown oxide prevelent. Possible siderite and barite through out.

Sample Number: Q011157 UTM: 525392 mE Nad83, Zone 8
Elevation: 1900 m UTM: 7121862 mN

Comments: weakly altered dolostone, minor presence of hydrothermal alteration, minor calcite veinlets and brown oxide filling vugs

Sample Number: Q011158 UTM: 525554 mE Nad83, Zone 8
Elevation: 1890 m UTM: 7121871 mN

Comments: Composite of handpit RWT-Hp-015, altered dolostone, sandy texture. With oxidized area new pit bottom.

Sample Number: Q011239 UTM: 525449 mE Nad83, Zone 8
Elevation: 1572 m UTM: 7121857 mN

Comments: Brown weathered, calcite veined limestone with grey matrix and local sooty spots.

Sample Number: Q011240 UTM: 525445 mE Nad83, Zone 8
Elevation: 1560 m UTM: 7121854 mN

Comments: Vuggy, brown weathered, non-calcareous dolostone, with grey fresh surface, possibly silicified.

Rock Sample DescriptionsProperty: Puma

Sample Number: Q011241 UTM: 525448 mE Nad83, Zone 8

Elevation: 1566 m UTM: 7121857 mN

Comments: Soil sample

Sample Number: Q011242 UTM: 525447 mE Nad83, Zone 8

Elevation: 1567 m UTM: 7121853 mN

Comments: Porous, vuggy, purple stained basalt, with brown oxide spots in matrix.

Sample Number: Q011243 UTM: 525450 mE Nad83, Zone 8

Elevation: 1570 m UTM: 7121857 mN

Comments: Very fine grained, non-calcareous, brown weathered matrix dolostone.

Sample Number: Q011244 UTM: 525485 mE Nad83, Zone 8

Elevation: 1556 m UTM: 7121854 mN

Comments: Soil taken from the bottom of the pit.

Sample Number: Q011245 UTM: 525486 mE Nad83, Zone 8

Elevation: 1553 m UTM: 7121855 mN

Comments: Brecciated, calcareous volcanic with small irregular subrounded fragments and grey coloured matrix.

Sample Number: Q011246 UTM: 525487 mE Nad83, Zone 8

Elevation: 1554 m UTM: 7121855 mN

Comments: Vuggy, calcareous, brecciated limestone with oxide weathering and large pyrite crystals.

Sample Number: Q011247 UTM: 525522 mE Nad83, Zone 8

Elevation: 1536 m UTM: 7121876 mN

Comments: Strongly calcareous, rusty with sooty spots limestone with large oxidized pyrite in matrix.

Rock Sample Descriptions

Property: Puma

Sample Number: Q011248 UTM: 525524 mE Nad83, Zone 8
Elevation: 1533 m UTM: 7121877 mN

Comments: Very fine grained, grey coloured dolostone with light grey clay alteration around the outcrop.

Sample Number: Q011249 UTM: 525526 mE Nad83, Zone 8
Elevation: 1536 m UTM: 7121876 mN

Comments: Silicified, vuggy dolostone, with large vugs, quartz forms large crystals, medium grained, almost completely silicified matrix.

Sample Number: Q011250 UTM: 525522 mE Nad83, Zone 8
Elevation: 1536 m UTM: 7121874 mN

Comments: Strongly calcareous, brecciated limestone, with greenish, porous basalt fragments.

Sample Number: Q011251 UTM: 525524 mE Nad83, Zone 8
Elevation: 1537 m UTM: 7121875 mN

Comments: Mineral soil, light grey coloured from the bottom of the pit.

Sample Number: Q011252 UTM: 525525 mE Nad83, Zone 8
Elevation: 1540 m UTM: 7121876 mN

Comments: Hydrothermally, brecciated with quartz rich matrix, angular dolomitic fragments.

Sample Number: Q011253 UTM: 525661 mE Nad83, Zone 8
Elevation: 1462 m UTM: 7121898 mN

Comments: Rusty, strongly altered rock with oxide alteration and calcareous matrix, fine grained and locally white weathered.

Sample Number: Q013951 UTM: 525495 mE Nad83, Zone 8
Elevation: 1578 m UTM: 7121827 mN

Comments: Upslope edge of recessive area; minor oxide on sugary, vuggy dolomite; sample Q013951- composite grab of sugary, vuggy dolomite float with oxide cavity fillings to ~20%

Rock Sample Descriptions

Property: Puma

Sample Number: Q013952 UTM: 525421 mE Nad83, Zone 8
Elevation: 1564 m UTM: 7121884 mN

Comments: Jordan's western fault trace, ~1m wide wet, recessive zone crossing continuous o/c face; sample of oxide float, 2cm x 4cm x 6cm, orange brown to chocolate brown

Sample Number: Q013953 UTM: 525409 mE Nad83, Zone 8
Elevation: 1579 m UTM: 7121875 mN

Comments: Sugary, chocolate brown oxide pebbles with thin orange streaks; ~25% white sucrosic granular quartz

APPENDIX IV
CERTIFICATES OF ANALYSIS



ALS Canada Ltd.
 2103 Dollarton Hwy
 North Vancouver BC V7H 0A7
 Phone: 604 984 0221 Fax: 604 984 0218 www.alsglobal.com

To: ATAC RESOURCES LTD.
 C/O ARCHER, CATHRO & ASSOCIATES (1981)
 LIMITED
 1016-510 W HASTINGS ST
 VANCOUVER BC V6B 1L8

Page: 1
 Total # Pages: 8 (A - D)
 Plus Appendix Pages
 Finalized Date: 26-SEP-2014
 Account: RCM

CERTIFICATE WH14146244

Project: Area G & H

This report is for 250 Soil samples submitted to our lab in Whitehorse, YT, Canada on 16-SEP-2014.

The following have access to data associated with this certificate:

ROB CARNE	JULIA LANE	JOAN MARIACHER
-----------	------------	----------------

SAMPLE PREPARATION	
ALS CODE	DESCRIPTION
WEI-21	Received Sample Weight
LOG-22	Sample login - Rcd w/o BarCode
SCR-41	Screen to -180um and save both

ANALYTICAL PROCEDURES		
ALS CODE	DESCRIPTION	INSTRUMENT
Au-ICP21	Au 30g FA ICP-AES Finish	ICP-AES
ME-MS41	51 anal. aqua regia ICPMS	

To: ATAC RESOURCES LTD.
 ATTN: JULIA LANE
 C/O ARCHER, CATHRO & ASSOCIATES (1981) LIMITED
 1016-510 W HASTINGS ST
 VANCOUVER BC V6B 1L8

This is the Final Report and supersedes any preliminary report with this certificate number. Results apply to samples as submitted. All pages of this report have been checked and approved for release.

***** See Appendix Page for comments regarding this certificate *****

Signature: 
 Colin Ramshaw, Vancouver Laboratory Manager



ALS Canada Ltd.
 2103 Dollarton Hwy
 North Vancouver BC V7H 0A7
 Phone: 604 984 0221 Fax: 604 984 0218 www.alsglobal.com

To: ATAC RESOURCES LTD.
 C/O ARCHER, CATHRO & ASSOCIATES (1981)
 LIMITED
 1016-510 W HASTINGS ST
 VANCOUVER BC V6B 1L8

Page: 2 - D
 Total # Pages: 8 (A - D)
 Plus Appendix Pages
 Finalized Date: 26-SEP-2014
 Account: RCM

Project: Area G & H

CERTIFICATE OF ANALYSIS WH14146244

Sample Description	Method	ME-MS41	ME-MS41	ME-MS41	ME-MS41	ME-MS41	ME-MS41	ME-MS41	ME-MS41
	Analyte	Ti	Ti	U	V	W	Y	Zn	Zr
Units		%	ppm	ppm	ppm	ppm	ppm	ppm	ppm
LOR		0.005	0.02	0.05	1	0.05	0.05	2	0.5
ZZ94180		0.017	0.30	3.20	54	0.21	9.12	91	1.1
ZZ94181		0.012	0.20	1.04	55	0.25	8.78	122	1.4
ZZ94182		0.006	0.75	2.14	58	0.07	10.85	133	2.4
ZZ94183		0.006	0.67	2.13	50	0.06	10.55	111	1.7
ZZ94184		0.006	1.09	2.73	62	0.06	10.90	159	3.9
ZZ94185		0.007	1.16	2.29	77	0.09	13.40	191	2.5
ZZ94186		0.006	0.89	2.45	73	0.08	13.25	159	2.1
ZZ94187		0.007	0.84	2.04	70	0.07	12.75	161	2.4
ZZ94188		0.009	0.85	2.20	61	0.11	13.45	159	1.9
ZZ94189		0.010	0.98	2.32	66	0.10	14.75	168	1.9
ZZ94190		0.008	1.20	2.12	66	0.09	13.35	171	2.1
ZZ94191		0.010	0.69	2.16	70	0.08	13.55	176	2.4
ZZ94192		0.006	0.81	2.72	68	0.08	14.15	194	2.4
ZZ94193		0.007	0.77	2.35	68	0.09	12.70	159	1.8
ZZ94194		0.007	0.89	2.16	66	0.07	14.90	168	2.4
ZZ94195		0.007	0.78	2.11	68	0.07	14.90	174	2.7
ZZ94196		0.009	0.93	3.29	69	0.08	13.45	196	2.4
ZZ94197		0.008	1.42	3.56	80	0.09	16.20	227	3.0
ZZ94198		0.010	0.62	3.19	38	0.06	7.88	117	1.5
ZZ94199		0.009	1.45	3.09	79	0.09	14.45	209	2.6
ZZ94200		0.009	1.53	2.57	84	0.11	13.95	211	2.0
ZZ94201		0.008	0.37	1.17	50	0.11	8.96	108	1.2
ZZ94202		0.010	0.35	1.22	45	0.18	15.00	98	2.3
ZZ94203		0.012	0.19	2.08	55	0.18	18.80	101	1.4
ZZ94204		0.013	0.24	2.02	65	0.09	13.95	270	2.3
ZZ94205		0.020	0.30	2.62	80	0.10	18.60	297	2.6
ZZ94206		0.012	0.34	2.52	86	0.07	22.3	326	3.4
ZZ94207		0.011	0.24	2.28	64	0.05	15.80	235	2.8
ZZ94208		0.016	0.22	2.11	55	0.06	13.70	303	2.4
ZZ94209		<0.005	0.10	8.60	38	0.06	18.10	37	2.2
ZZ94210		<0.005	0.66	15.35	244	0.20	44.4	315	2.3
ZZ94211		<0.005	0.50	11.25	206	0.26	30.1	348	2.5
ZZ94212		<0.005	1.08	13.60	223	0.17	24.0	630	2.7
ZZ94213		<0.005	1.02	12.80	239	0.19	31.0	863	2.3
ZZ94214		0.005	0.80	9.10	217	0.17	33.8	2040	2.4
ZZ94215		<0.005	0.64	9.02	110	0.14	36.8	263	2.8
ZZ94216		0.009	0.17	4.36	54	0.19	26.4	182	2.2
ZZ94217		<0.005	0.70	11.15	265	0.13	29.7	311	2.6
ZZ94218		0.005	0.52	10.90	187	0.11	25.5	431	2.5
ZZ94219		<0.005	0.66	9.05	256	0.10	27.9	387	2.2



ALS Canada Ltd.
 2103 Dollarton Hwy
 North Vancouver BC V7H 0A7
 Phone: 604 984 0221 Fax: 604 984 0218 www.alsglobal.com

To: ATAC RESOURCES LTD.
 C/O ARCHER, CATHRO & ASSOCIATES (1981)
 LIMITED
 1016-510 W HASTINGS ST
 VANCOUVER BC V6B 1L8

Page: 3 - D
 Total # Pages: 8 (A - D)
 Plus Appendix Pages
 Finalized Date: 26-SEP-2014
 Account: RCM

Project: Area G & H

CERTIFICATE OF ANALYSIS WH14146244

Sample Description	Method Analyte Units LOR	ME-MS41	ME-MS41	ME-MS41	ME-MS41	ME-MS41	ME-MS41	ME-MS41	ME-MS41
		Ti %	Ti ppm	U ppm	V ppm	W ppm	Y ppm	Zn ppm	Zr ppm
		0.005	0.02	0.05	1	0.05	0.05	2	0.5
ZZ94220		0.006	0.70	13.50	253	0.23	39.9	383	2.5
ZZ94221		0.010	0.29	1.47	37	0.07	12.15	106	2.9
ZZ94222		0.008	0.21	1.49	30	0.06	11.50	99	2.2
ZZ94223		0.009	0.24	1.41	33	0.06	11.35	103	1.9
ZZ94224		0.009	0.22	1.50	29	0.06	9.75	97	3.2
ZZ94225		0.010	0.21	1.50	52	0.10	14.40	118	1.7
ZZ94226		0.007	0.16	1.80	29	0.07	8.36	91	1.9
ZZ94227		0.008	0.19	1.26	30	0.05	11.10	105	3.2
ZZ94228		0.014	0.29	1.80	46	0.14	11.25	113	1.3
ZZ94229		0.011	0.26	1.31	37	0.07	11.35	116	1.8
ZZ94230		0.016	0.18	1.19	39	0.10	12.00	90	1.7
ZZ94231		0.014	0.14	1.18	49	0.18	11.50	83	2.3
ZZ94232		0.013	0.14	1.23	49	0.15	10.55	95	2.1
ZZ94233		0.011	0.13	0.91	39	0.09	10.85	106	2.3
ZZ94234		0.008	0.17	1.18	35	0.06	11.35	93	2.7
ZZ94235		0.008	0.22	1.24	34	0.05	10.45	85	4.4
ZZ94236		0.009	0.22	1.24	35	0.06	10.40	91	4.0
ZZ94237		0.027	0.13	0.72	52	0.25	11.10	101	1.4
ZZ94238		0.012	0.18	1.24	50	0.09	10.40	134	2.2
ZZ94239		0.007	0.68	2.37	59	0.06	12.30	140	2.1
ZZ94240		<0.005	0.72	2.07	21	<0.05	4.85	77	1.1
ZZ94241		0.007	0.49	2.10	27	0.07	9.63	71	1.5
ZZ94242		0.009	1.32	2.75	68	0.19	12.50	202	2.0
ZZ94243		0.007	0.58	2.09	54	0.08	10.80	138	1.8
ZZ94244		0.008	0.57	2.41	45	0.12	9.46	121	1.5
ZZ94245		0.008	0.54	1.96	42	0.07	9.01	110	1.2
ZZ94246		0.008	0.67	2.01	34	0.08	6.25	112	1.2
ZZ94247		0.008	0.91	2.13	62	0.11	12.05	178	1.7
ZZ94248		0.011	1.18	1.97	58	0.10	13.45	201	1.7
ZZ94249		0.011	1.01	1.88	64	0.10	13.65	238	1.7
ZZ94250		0.010	1.30	2.13	75	0.10	13.10	210	1.8
ZZ94251		0.015	0.42	3.43	177	0.18	11.70	373	0.8
ZZ94252		0.016	0.34	3.15	190	0.20	11.10	499	1.0
ZZ94253		0.011	0.29	2.94	123	0.16	14.40	528	1.2
ZZ94254		0.009	0.47	3.80	186	0.17	15.15	566	1.1
ZZ94255		0.013	0.46	4.87	356	0.22	18.20	755	1.5
ZZ94256		0.021	0.62	6.48	654	0.29	22.2	1030	2.4
ZZ94257		0.017	0.63	7.82	645	0.27	22.2	1140	1.3
ZZ94258		0.019	0.70	7.30	546	0.27	20.9	1650	2.2
ZZ94259		0.016	0.61	7.00	477	0.33	19.30	1160	2.0



ALS Canada Ltd.
 2103 Dollarton Hwy
 North Vancouver BC V7H 0A7
 Phone: 604 984 0221 Fax: 604 984 0218 www.alsglobal.com

To: ATAC RESOURCES LTD.
 C/O ARCHER, CATHRO & ASSOCIATES (1981)
 LIMITED
 1016-510 W HASTINGS ST
 VANCOUVER BC V6B 1L8

Page: 4 - A
 Total # Pages: 8 (A - D)
 Plus Appendix Pages
 Finalized Date: 26-SEP-2014
 Account: RCM

Project: Area G & H

CERTIFICATE OF ANALYSIS WH14146244

Sample Description	Method Analyte Units LOR	WEI-21 Recvd Wt. kg	Au-ICP21 Au ppm	ME-MS41 Ag ppm	ME-MS41 Al %	ME-MS41 As ppm	ME-MS41 Au ppm	ME-MS41 B ppm	ME-MS41 Ba ppm	ME-MS41 Be ppm	ME-MS41 Bi ppm	ME-MS41 Ca %	ME-MS41 Cd ppm	ME-MS41 Ce ppm	ME-MS41 Co ppm	ME-MS41 Cr ppm
	LOR	0.02	0.001	0.01	0.01	0.1	0.2	10	10	0.05	0.01	0.01	0.01	0.02	0.1	1
ZZ94260		0.19	0.007	2.95	1.18	22.8	<0.2	<10	1690	0.80	0.21	0.81	11.60	26.8	5.9	82
ZZ94261		0.32	0.004	1.43	1.05	50.8	<0.2	<10	3140	0.83	0.20	1.08	8.40	28.6	12.8	43
ZZ94262		0.30	0.002	1.09	0.82	53.6	<0.2	<10	2300	0.66	0.17	0.88	6.21	27.4	6.9	40
ZZ94263		0.25	0.002	0.87	0.48	22.2	<0.2	<10	1100	0.22	0.13	0.13	1.70	34.9	1.4	12
ZZ94264		0.45	0.003	0.57	0.89	34.4	<0.2	<10	1100	0.55	0.18	0.49	3.07	34.0	14.2	37
ZZ94265		0.41	0.004	1.61	0.84	40.9	<0.2	<10	3020	0.72	0.19	1.98	25.8	25.9	14.4	57
ZZ94266		0.43	0.001	0.82	0.72	69.0	<0.2	<10	1970	0.61	0.15	0.84	10.70	24.4	11.1	42
ZZ94267		0.35	0.003	1.48	1.01	40.0	<0.2	<10	3360	0.86	0.21	1.17	10.25	26.7	12.0	56
ZZ94268		0.36	0.003	1.13	1.05	25.4	<0.2	<10	2740	0.65	0.20	0.89	4.01	27.2	9.9	41
ZZ94269		0.47	0.004	1.32	1.06	27.5	<0.2	<10	1180	0.68	0.22	1.98	3.84	26.7	15.2	45
ZZ94270		0.35	0.001	0.98	0.73	45.2	<0.2	<10	830	0.69	0.25	0.78	5.16	21.2	18.3	34
ZZ94271		0.27	0.001	0.72	0.67	23.6	<0.2	<10	1440	0.49	0.14	2.46	4.62	17.20	10.5	28
ZZ94272		0.32	0.002	0.89	0.82	33.1	<0.2	<10	2320	0.56	0.16	0.96	7.45	21.6	8.7	39
ZZ94273		0.23	0.004	0.67	0.91	11.7	<0.2	<10	1590	0.47	0.16	3.26	3.61	17.20	7.5	23
ZZ94274		0.46	0.005	2.84	1.19	44.2	<0.2	<10	3000	0.94	0.20	1.60	13.60	31.3	14.4	70
ZZ94275		0.22	0.001	0.69	0.91	25.3	<0.2	<10	1100	0.58	0.19	1.25	4.16	25.1	8.9	33
ZZ94276		0.29	<0.001	0.22	2.31	20.4	<0.2	<10	480	1.02	0.23	0.88	0.74	42.4	10.2	48
ZZ94277		0.42	0.001	0.34	0.72	11.9	<0.2	<10	1450	0.42	0.11	10.00	1.74	13.45	6.2	22
ZZ94278		0.44	<0.001	0.32	0.66	12.2	<0.2	<10	1520	0.42	0.10	12.40	2.08	13.20	6.1	19
ZZ94279		0.42	0.001	0.30	0.63	12.5	<0.2	<10	1610	0.34	0.09	13.25	2.14	12.80	6.4	20
ZZ94280		0.36	<0.001	0.24	0.61	9.8	<0.2	<10	1340	0.34	0.08	14.15	1.53	12.60	5.7	17
ZZ94281		0.42	<0.001	0.32	0.92	10.9	<0.2	<10	1150	0.50	0.13	7.01	1.22	17.75	6.6	24
ZZ94282		0.26	0.001	0.48	0.82	18.3	<0.2	<10	2430	0.56	0.16	3.34	2.45	17.45	10.7	24
ZZ94283		0.26	<0.001	0.41	0.79	13.6	<0.2	<10	1810	0.47	0.16	3.88	1.99	19.05	9.0	24
ZZ94284		0.39	<0.001	0.36	0.77	14.0	<0.2	<10	1280	0.47	0.14	4.86	1.89	17.95	8.3	22
ZZ94285		0.29	<0.001	0.39	0.81	12.0	<0.2	<10	1150	0.48	0.14	4.61	1.70	18.05	8.1	23
ZZ94286		0.26	0.003	0.36	0.88	18.0	<0.2	<10	1310	0.56	0.15	4.75	2.01	16.65	9.7	21
ZZ94287		0.47	<0.001	0.33	0.87	13.3	<0.2	<10	880	0.58	0.15	7.79	1.78	16.55	8.4	22
ZZ94288		0.40	0.002	0.26	0.90	16.6	<0.2	<10	1170	0.41	0.17	1.30	1.49	27.4	10.0	27
ZZ94289		0.37	0.003	1.03	1.37	62.1	<0.2	<10	3480	0.98	0.27	0.71	5.09	34.0	20.0	49
ZZ94290		0.32	0.001	0.66	1.14	35.1	<0.2	<10	3800	0.76	0.22	0.97	7.80	26.3	20.2	47
ZZ94291		0.28	0.002	1.10	1.24	62.3	<0.2	<10	4130	0.97	0.28	1.67	4.88	24.7	17.5	41
ZZ94292		0.33	0.002	0.77	1.09	31.3	<0.2	<10	3890	0.87	0.26	1.19	7.17	23.7	17.0	37
ZZ94293		0.23	0.002	1.30	0.91	46.3	<0.2	<10	2750	0.54	0.20	1.32	2.81	29.0	12.9	35
ZZ94294		0.33	0.001	1.00	1.10	34.7	<0.2	<10	3220	0.62	0.22	1.14	4.50	27.1	11.0	35
ZZ94295		0.22	0.004	1.19	0.80	17.2	<0.2	<10	2960	0.45	0.21	1.44	6.56	26.3	12.0	27
ZZ94296		0.28	0.002	2.54	1.31	17.5	<0.2	<10	2970	0.83	0.22	0.86	3.54	23.9	7.2	115
ZZ94297		0.38	0.002	1.73	1.16	36.5	<0.2	<10	2360	0.52	0.26	0.70	2.56	27.0	8.5	68
ZZ94298		0.39	0.002	1.32	0.99	32.9	<0.2	<10	3330	0.73	0.19	1.20	10.25	28.1	13.5	47
ZZ94299		0.34	0.002	1.37	1.09	37.2	<0.2	<10	3620	0.72	0.20	1.14	3.39	25.8	11.6	46



ALS Canada Ltd.
 2103 Dollarton Hwy
 North Vancouver BC V7H 0A7
 Phone: 604 984 0221 Fax: 604 984 0218 www.alsglobal.com

To: ATAC RESOURCES LTD.
 C/O ARCHER, CATHRO & ASSOCIATES (1981)
 LIMITED
 1016-510 W HASTINGS ST
 VANCOUVER BC V6B 1L8

Page: 4 - B
 Total # Pages: 8 (A - D)
 Plus Appendix Pages
 Finalized Date: 26-SEP-2014
 Account: RCM

Project: Area G & H

CERTIFICATE OF ANALYSIS WH14146244

Sample Description	Method Analyte Units LOR	ME-MS41	ME-MS41	ME-MS41	ME-MS41	ME-MS41	ME-MS41	ME-MS41	ME-MS41	ME-MS41	ME-MS41	ME-MS41	ME-MS41	ME-MS41	ME-MS41	
		Cs ppm	Cu ppm	Fe %	Ga ppm	Ge ppm	Hf ppm	Hg ppm	In ppm	K %	La ppm	Li ppm	Mg %	Mn ppm	Mo ppm	Na %
		0.05	0.2	0.01	0.05	0.05	0.02	0.01	0.005	0.01	0.2	0.1	0.01	5	0.05	0.01
ZZ94260		1.39	82.4	1.77	5.36	0.08	0.03	0.66	0.027	0.10	17.1	12.0	0.69	163	3.98	0.01
ZZ94261		1.14	94.2	3.16	3.71	0.07	0.05	0.47	0.033	0.14	17.1	10.7	0.56	560	14.00	0.01
ZZ94262		0.88	73.7	2.25	2.97	0.07	0.05	0.35	0.028	0.12	16.1	9.0	0.41	184	11.10	0.01
ZZ94263		0.37	24.6	1.22	1.61	0.06	0.11	0.17	0.018	0.06	24.2	3.5	0.13	37	8.41	0.01
ZZ94264		0.58	57.5	3.20	3.61	0.07	<0.02	0.15	0.030	0.10	20.2	7.9	0.25	447	14.60	0.01
ZZ94265		1.05	102.0	3.08	3.83	0.09	0.10	0.30	0.033	0.13	16.7	8.7	1.14	448	19.95	<0.01
ZZ94266		0.85	61.3	4.00	2.93	0.09	0.04	0.24	0.031	0.11	15.6	6.9	0.31	558	35.0	<0.01
ZZ94267		0.95	90.7	2.96	4.08	0.08	0.06	0.38	0.032	0.12	17.4	10.0	0.66	462	16.35	<0.01
ZZ94268		0.82	56.3	2.47	3.90	0.07	0.03	0.27	0.032	0.08	17.3	10.5	0.39	312	8.21	<0.01
ZZ94269		0.91	35.6	3.03	3.82	0.07	0.04	0.27	0.041	0.08	17.5	12.6	0.69	617	6.96	<0.01
ZZ94270		0.60	66.6	4.51	2.72	0.08	0.05	0.19	0.047	0.04	12.6	9.0	0.42	542	12.55	<0.01
ZZ94271		0.53	35.0	2.49	2.25	0.06	0.03	0.20	0.023	0.06	14.2	6.7	0.36	767	5.19	0.01
ZZ94272		0.89	52.5	1.84	2.74	0.07	0.04	0.29	0.029	0.08	13.4	8.6	0.39	266	6.06	<0.01
ZZ94273		0.51	41.6	1.76	2.74	<0.05	0.04	0.16	0.020	0.03	10.4	8.0	0.30	474	1.86	<0.01
ZZ94274		0.98	120.5	3.03	4.23	0.09	0.06	0.60	0.041	0.11	19.7	11.7	1.04	630	15.00	<0.01
ZZ94275		0.64	42.3	2.71	3.02	0.05	0.05	0.22	0.026	0.07	16.7	9.6	0.32	143	5.05	<0.01
ZZ94276		1.09	13.5	3.54	5.15	0.07	0.05	0.04	0.037	0.05	25.8	13.0	0.36	333	3.65	0.01
ZZ94277		0.58	18.8	1.76	2.03	<0.05	0.04	0.11	0.017	0.10	8.6	7.7	3.86	346	2.58	0.01
ZZ94278		0.64	19.9	1.67	2.06	<0.05	0.03	0.11	0.019	0.10	8.4	7.5	3.80	329	2.58	0.01
ZZ94279		0.66	23.9	1.68	1.90	<0.05	0.05	0.11	0.016	0.11	7.7	6.9	4.30	357	2.74	0.01
ZZ94280		0.62	21.8	1.53	1.85	<0.05	0.05	0.13	0.014	0.10	7.3	7.2	4.72	333	1.99	0.01
ZZ94281		0.65	28.0	2.01	2.64	<0.05	0.05	0.14	0.021	0.11	10.5	10.3	3.78	231	1.94	0.01
ZZ94282		0.56	37.2	2.55	2.53	<0.05	0.04	0.17	0.024	0.06	10.9	9.4	1.17	915	3.73	<0.01
ZZ94283		0.65	25.4	2.26	2.52	<0.05	0.05	0.17	0.023	0.07	11.9	10.9	1.81	296	2.27	0.01
ZZ94284		0.60	26.2	2.31	2.35	0.05	0.04	0.12	0.020	0.07	11.7	9.6	2.23	806	2.42	0.01
ZZ94285		0.64	25.4	2.12	2.45	<0.05	0.04	0.16	0.023	0.08	11.1	9.3	2.41	579	2.37	0.01
ZZ94286		0.57	29.0	2.76	2.59	0.05	0.04	0.16	0.025	0.06	10.5	10.3	1.72	909	2.39	0.01
ZZ94287		0.78	29.9	2.16	2.46	0.05	0.05	0.15	0.024	0.09	9.4	14.0	3.75	262	3.16	0.01
ZZ94288		1.01	31.8	2.66	3.04	0.07	0.12	0.09	0.021	0.06	14.7	13.6	0.88	412	5.48	0.01
ZZ94289		2.02	62.9	4.35	4.55	0.08	0.06	0.62	0.043	0.14	17.8	17.2	0.68	692	14.35	0.01
ZZ94290		1.27	65.8	3.57	3.74	0.08	0.04	0.28	0.037	0.08	14.6	13.7	0.70	1360	13.00	<0.01
ZZ94291		1.38	79.8	4.16	3.98	0.05	0.06	0.54	0.043	0.11	14.1	12.7	0.95	1100	9.32	0.01
ZZ94292		0.83	77.4	3.24	3.58	0.06	0.05	0.42	0.038	0.07	13.2	10.2	0.47	1130	7.16	0.01
ZZ94293		0.64	36.8	3.01	2.99	0.06	0.05	0.36	0.030	0.08	16.3	10.5	0.49	602	6.85	0.01
ZZ94294		0.75	49.6	2.59	3.47	<0.05	0.05	0.38	0.032	0.08	15.2	11.7	0.40	317	3.25	<0.01
ZZ94295		0.92	109.0	1.97	2.74	0.06	0.07	0.28	0.029	0.08	14.8	10.5	0.44	406	1.98	<0.01
ZZ94296		1.45	66.5	1.93	4.96	0.08	<0.02	0.33	0.030	0.10	15.5	14.0	1.03	128	4.20	<0.01
ZZ94297		1.02	37.2	2.73	4.62	0.07	<0.02	0.31	0.032	0.11	16.4	13.6	0.61	266	7.12	<0.01
ZZ94298		0.98	66.7	2.83	3.36	0.07	0.05	0.32	0.029	0.13	16.6	10.0	0.50	1240	11.20	<0.01
ZZ94299		0.84	41.5	2.83	3.72	0.06	0.05	0.31	0.032	0.12	15.8	11.3	0.44	943	11.20	<0.01



ALS Canada Ltd.
 2103 Dollarton Hwy
 North Vancouver BC V7H 0A7
 Phone: 604 984 0221 Fax: 604 984 0218 www.alsglobal.com

To: ATAC RESOURCES LTD.
 C/O ARCHER, CATHRO & ASSOCIATES (1981)
 LIMITED
 1016-510 W HASTINGS ST
 VANCOUVER BC V6B 1L8

Page: 4 - D
 Total # Pages: 8 (A - D)
 Plus Appendix Pages
 Finalized Date: 26-SEP-2014
 Account: RCM

Project: Area G & H

CERTIFICATE OF ANALYSIS WH14146244

Sample Description	Method	ME-MS41	ME-MS41	ME-MS41	ME-MS41	ME-MS41	ME-MS41	ME-MS41	ME-MS41
	Analyte	Ti	Ti	U	V	W	Y	Zn	Zr
Units		%	ppm	ppm	ppm	ppm	ppm	ppm	ppm
LOR		0.005	0.02	0.05	1	0.05	0.05	2	0.5
ZZ94260		0.016	0.70	5.75	602	0.22	16.05	867	1.1
ZZ94261		0.013	0.67	3.47	234	0.24	16.65	824	2.5
ZZ94262		0.015	0.51	3.59	235	0.17	15.45	626	2.6
ZZ94263		0.005	0.27	1.84	70	0.18	6.10	127	7.2
ZZ94264		0.017	0.65	2.49	234	0.23	13.05	513	<0.5
ZZ94265		0.016	1.16	4.05	363	0.27	20.6	1490	6.0
ZZ94266		0.011	0.65	4.69	406	0.26	17.15	870	2.0
ZZ94267		0.013	0.80	3.79	383	0.26	22.0	975	3.1
ZZ94268		0.017	0.49	3.39	232	0.24	18.05	494	1.5
ZZ94269		0.013	0.74	2.62	205	0.22	16.65	606	1.8
ZZ94270		0.013	0.35	1.98	154	0.16	11.95	459	2.2
ZZ94271		0.009	0.41	3.14	136	0.13	15.85	337	1.1
ZZ94272		0.013	0.54	4.19	243	0.15	14.50	813	1.6
ZZ94273		0.017	0.13	2.79	63	0.19	9.43	182	1.3
ZZ94274		0.012	1.02	6.94	377	0.27	31.0	1080	2.5
ZZ94275		0.012	0.38	2.27	124	0.20	16.50	316	2.0
ZZ94276		0.017	0.32	1.78	98	0.25	21.8	136	1.3
ZZ94277		0.007	0.22	1.64	59	0.07	10.25	162	1.3
ZZ94278		0.006	0.26	1.48	53	0.08	9.75	141	1.0
ZZ94279		0.008	0.29	1.47	55	0.07	9.29	159	2.3
ZZ94280		0.007	0.24	1.40	40	0.06	8.69	116	2.6
ZZ94281		0.009	0.21	1.33	55	0.09	11.75	153	1.8
ZZ94282		0.009	0.22	1.52	79	0.11	11.35	204	1.1
ZZ94283		0.013	0.24	1.53	76	0.11	12.10	207	1.8
ZZ94284		0.011	0.19	1.30	60	0.08	11.95	160	1.4
ZZ94285		0.010	0.21	1.26	60	0.10	11.55	176	1.5
ZZ94286		0.008	0.17	2.24	55	0.08	11.95	175	1.0
ZZ94287		0.006	0.20	1.19	48	0.07	11.85	157	1.9
ZZ94288		0.045	0.28	0.86	54	0.44	9.67	150	4.9
ZZ94289		0.035	0.63	2.29	140	0.18	11.00	522	2.7
ZZ94290		0.023	0.80	4.03	246	0.15	13.60	851	1.4
ZZ94291		0.013	0.68	2.67	153	0.18	12.15	517	1.9
ZZ94292		0.011	0.39	3.51	142	0.12	11.75	330	1.7
ZZ94293		0.015	0.34	2.61	150	0.15	13.25	392	2.1
ZZ94294		0.013	0.32	4.25	142	0.15	13.75	297	1.9
ZZ94295		0.016	0.36	9.38	97	0.14	16.30	291	2.6
ZZ94296		0.020	0.45	5.94	277	0.25	15.90	666	<0.5
ZZ94297		0.013	0.51	3.51	261	0.32	11.60	589	<0.5
ZZ94298		0.013	0.70	5.10	266	0.20	19.20	800	2.6
ZZ94299		0.011	0.55	3.41	271	0.20	15.80	483	1.9



ALS Canada Ltd.

2103 Dollarton Hwy
 North Vancouver BC V7H 0A7

Phone: 604 984 0221 Fax: 604 984 0218 www.alsglobal.com

To: ATAC RESOURCES LTD.
 C/O ARCHER, CATHRO & ASSOCIATES (1981)
 LIMITED
 1016-510 W HASTINGS ST
 VANCOUVER BC V6B 1L8

Page: 5 - A
 Total # Pages: 8 (A - D)
 Plus Appendix Pages
 Finalized Date: 26-SEP-2014
 Account: RCM

Project: Area G & H

CERTIFICATE OF ANALYSIS WH14146244

Sample Description	Method Analyte Units LOR	WEI-21	Au-ICP21	ME-MS41	ME-MS41	ME-MS41	ME-MS41	ME-MS41	ME-MS41	ME-MS41	ME-MS41	ME-MS41	ME-MS41	ME-MS41	ME-MS41	
		Recvd Wt.	Au	Ag	Al	As	Au	B	Ba	Be	Bi	Ca	Cd	Ce	Co	Cr
		kg	ppm	ppm	%	ppm	ppm	ppm	ppm	ppm	ppm	%	ppm	ppm	ppm	ppm
ZZ94300		0.28	0.001	1.20	0.96	18.7	<0.2	<10	2270	0.53	0.20	0.72	2.70	23.8	3.0	44
ZZ94301		0.27	0.001	1.24	0.93	26.7	<0.2	<10	3030	0.67	0.17	1.71	5.41	22.6	10.7	43
ZZ94302		0.31	0.002	1.16	1.01	28.0	<0.2	<10	3850	0.89	0.17	0.99	10.80	24.5	10.6	53
ZZ94303		0.49	0.002	1.19	1.14	27.6	<0.2	<10	3450	0.88	0.17	2.35	9.03	22.5	8.5	45
ZZ94304		0.38	0.002	1.03	0.96	21.3	<0.2	<10	3350	0.73	0.16	2.88	8.38	20.8	7.6	38
ZZ94305		0.40	0.002	1.25	1.13	21.1	<0.2	<10	1980	0.75	0.19	1.22	5.22	27.6	11.2	49
ZZ94306		0.40	0.004	1.10	1.10	19.3	<0.2	<10	1920	0.66	0.18	1.68	4.25	27.3	9.5	42
ZZ94307		0.48	0.001	0.65	0.92	20.8	<0.2	<10	2500	0.62	0.14	7.49	3.71	17.30	8.1	32
ZZ94308		0.24	0.001	0.52	1.19	15.7	<0.2	<10	1330	0.74	0.16	3.66	2.28	20.4	8.9	34
ZZ94309		0.60	<0.001	0.35	0.89	11.3	<0.2	<10	1150	0.51	0.12	5.05	1.36	16.95	6.9	27
ZZ94310		0.23	0.004	0.75	1.20	17.7	<0.2	<10	890	0.73	0.17	3.08	1.39	21.3	7.5	33
ZZ94311		0.30	0.002	0.49	0.95	24.1	<0.2	<10	640	0.59	0.15	0.70	0.55	20.4	6.8	30
ZZ94312		0.41	0.003	0.40	0.71	13.7	<0.2	<10	1550	0.45	0.11	8.76	1.54	14.20	6.8	24
ZZ94313		0.42	0.002	0.42	0.75	11.1	<0.2	<10	1500	0.48	0.12	4.30	2.37	16.30	6.7	24
ZZ94314		0.37	0.009	1.37	1.42	25.2	<0.2	<10	1300	0.93	0.17	2.42	4.49	29.3	10.7	35
ZZ94315		0.42	0.003	0.35	0.80	13.8	<0.2	<10	830	0.61	0.14	11.05	1.32	16.10	8.6	19
ZZ94316		0.46	0.004	0.40	0.73	14.0	<0.2	<10	1080	0.74	0.16	5.88	1.89	17.05	12.0	20
ZZ94317		0.35	0.003	0.31	1.05	15.1	<0.2	<10	420	0.66	0.17	4.17	1.16	17.70	10.7	23
ZZ94318		0.31	0.003	0.16	1.48	11.4	<0.2	<10	260	0.75	0.22	2.86	0.50	25.7	8.7	27
ZZ94319		0.36	0.003	0.42	1.24	15.9	<0.2	<10	380	0.74	0.20	4.26	1.25	24.5	9.1	26
ZZ94320		0.37	0.008	2.26	1.00	215	<0.2	<10	680	0.99	0.27	1.12	2.31	32.5	15.6	35
ZZ94321		0.39	0.006	0.34	0.59	130.5	<0.2	<10	270	0.46	0.25	0.04	0.72	29.2	16.4	12
ZZ94322		0.46	0.006	2.25	0.68	4310	<0.2	<10	590	0.88	0.42	0.07	6.91	21.5	11.7	14
ZZ94323		0.36	0.003	0.25	1.65	41.4	<0.2	<10	570	0.58	0.26	0.30	1.75	28.0	8.5	31
ZZ94324		0.30	0.004	1.00	0.82	47.2	<0.2	<10	3960	0.83	0.18	3.86	3.56	20.7	12.0	29
ZZ94325		0.33	0.004	1.29	1.07	42.1	<0.2	<10	2480	0.83	0.22	1.61	4.40	22.0	13.2	37
ZZ94326		0.34	0.004	1.04	1.23	39.7	<0.2	<10	3020	0.91	0.23	1.18	6.78	25.8	22.1	41
ZZ94327		0.26	0.004	0.96	1.19	43.4	<0.2	<10	2640	0.84	0.21	1.22	2.78	21.9	14.6	38
ZZ94328		0.45	0.003	1.85	1.02	15.3	<0.2	<10	2380	0.52	0.17	0.88	2.39	30.7	7.3	50
ZZ94329		0.30	0.004	1.43	1.26	22.3	<0.2	<10	3000	0.74	0.20	0.96	4.14	23.8	8.0	75
ZZ94330		0.29	0.006	3.44	1.51	21.3	<0.2	<10	3450	1.44	0.14	1.92	9.70	19.60	7.0	146
ZZ94331		0.26	0.008	3.80	1.46	28.8	<0.2	<10	2750	1.82	0.13	1.86	19.75	22.2	6.9	214
ZZ94332		0.32	0.007	1.39	1.03	35.3	<0.2	<10	3750	0.78	0.18	2.37	8.07	22.5	10.0	48
ZZ94333		0.39	0.005	1.39	1.39	25.1	<0.2	<10	3440	0.91	0.17	0.62	3.78	29.4	10.6	51
ZZ94334		0.37	0.004	1.15	1.40	22.6	<0.2	<10	3060	0.88	0.18	1.49	2.37	25.9	9.9	34
ZZ94335		0.42	0.004	1.06	1.21	21.2	<0.2	<10	4340	0.76	0.18	1.37	3.64	23.4	10.7	34
ZZ94336		0.38	0.003	0.58	0.84	18.6	<0.2	<10	3910	0.50	0.12	8.39	3.05	15.30	7.5	26
ZZ94337		0.26	0.022	0.90	0.95	16.9	<0.2	<10	4230	0.63	0.15	2.96	4.14	16.85	7.5	28
ZZ94338		0.27	0.003	0.58	0.99	13.8	<0.2	<10	2000	0.48	0.15	1.67	1.58	17.85	7.1	24
ZZ94339		0.31	0.004	0.81	1.57	25.9	<0.2	<10	1570	1.16	0.15	1.65	1.55	33.3	10.6	44

***** See Appendix Page for comments regarding this certificate *****



ALS Canada Ltd.
 2103 Dollarton Hwy
 North Vancouver BC V7H 0A7
 Phone: 604 984 0221 Fax: 604 984 0218 www.alsglobal.com

To: ATAC RESOURCES LTD.
 C/O ARCHER, CATHRO & ASSOCIATES (1981)
 LIMITED
 1016-510 W HASTINGS ST
 VANCOUVER BC V6B 1L8

Page: 5 - B
 Total # Pages: 8 (A - D)
 Plus Appendix Pages
 Finalized Date: 26-SEP-2014
 Account: RCM

Project: Area G & H

CERTIFICATE OF ANALYSIS WH14146244

Sample Description	Method Analyte Units LOR	ME-MS41 Cs ppm	ME-MS41 Cu ppm	ME-MS41 Fe %	ME-MS41 Ga ppm	ME-MS41 Ge ppm	ME-MS41 Hf ppm	ME-MS41 Hg ppm	ME-MS41 In ppm	ME-MS41 K %	ME-MS41 La ppm	ME-MS41 Li ppm	ME-MS41 Mg %	ME-MS41 Mn ppm	ME-MS41 Mo ppm	ME-MS41 Na %
		0.05	0.2	0.01	0.05	0.05	0.02	0.01	0.005	0.01	0.2	0.1	0.01	5	0.05	0.01
ZZ94300		0.87	32.3	1.39	3.75	0.05	0.02	0.35	0.030	0.10	14.9	8.8	0.30	57	1.67	<0.01
ZZ94301		1.01	50.3	2.57	3.45	0.07	0.04	0.33	0.026	0.11	14.0	9.1	0.82	349	7.42	<0.01
ZZ94302		0.87	61.6	2.73	3.64	0.07	0.04	0.24	0.028	0.12	16.7	9.2	0.58	293	10.60	<0.01
ZZ94303		0.99	91.1	2.55	4.19	0.06	0.06	0.33	0.031	0.14	15.8	9.7	1.09	360	13.20	0.01
ZZ94304		0.83	73.5	2.34	3.47	0.07	0.07	0.24	0.027	0.12	14.2	9.4	1.26	337	8.86	<0.01
ZZ94305		0.64	40.9	2.44	4.28	0.06	0.04	0.27	0.031	0.08	19.4	12.7	0.51	424	7.57	<0.01
ZZ94306		0.71	43.0	2.57	3.99	0.06	0.06	0.28	0.032	0.09	16.5	12.9	0.86	173	5.18	<0.01
ZZ94307		0.84	37.9	2.40	2.90	0.05	0.05	0.19	0.024	0.12	12.1	8.8	2.44	355	5.91	0.01
ZZ94308		0.76	37.4	2.56	3.67	0.05	0.04	0.16	0.025	0.11	13.5	13.1	1.66	386	3.44	0.01
ZZ94309		0.64	19.7	2.01	2.60	<0.05	0.04	0.13	0.019	0.10	9.9	9.7	2.55	378	2.12	0.01
ZZ94310		0.48	20.1	2.38	3.44	0.05	0.03	0.18	0.025	0.04	16.1	9.1	0.57	361	3.31	0.01
ZZ94311		0.76	11.9	2.68	2.95	<0.05	0.04	0.17	0.027	0.09	11.6	9.8	0.30	149	9.77	<0.01
ZZ94312		0.64	29.2	2.14	2.11	<0.05	0.04	0.15	0.019	0.09	8.6	7.7	2.99	441	3.88	0.01
ZZ94313		0.53	26.3	2.06	2.28	<0.05	0.05	0.16	0.019	0.07	10.6	8.4	1.70	257	2.53	0.01
ZZ94314		0.74	42.9	2.85	3.10	0.07	0.07	0.27	0.035	0.05	18.4	10.3	1.26	442	6.15	<0.01
ZZ94315		0.69	31.4	2.38	2.39	0.05	0.05	0.28	0.021	0.07	8.9	10.4	3.72	406	2.36	0.01
ZZ94316		0.46	42.6	3.00	2.29	<0.05	0.05	0.19	0.024	0.06	10.3	9.4	2.98	2130	3.09	0.01
ZZ94317		3.46	29.2	3.17	3.26	0.06	0.06	0.13	0.028	0.06	9.3	21.4	2.10	306	5.12	0.01
ZZ94318		1.20	18.1	3.17	4.43	<0.05	0.04	0.07	0.043	0.06	12.9	27.4	1.34	637	3.97	0.01
ZZ94319		0.91	14.0	2.90	3.49	<0.05	0.03	0.12	0.032	0.06	13.4	18.3	2.08	625	2.20	0.01
ZZ94320		0.77	74.5	4.78	3.35	0.06	0.03	0.93	0.046	0.09	18.0	9.6	0.57	478	5.84	0.01
ZZ94321		1.19	25.1	4.09	3.99	0.05	<0.02	0.09	0.033	0.06	15.4	2.2	0.05	719	6.74	<0.01
ZZ94322		0.92	76.8	9.72	3.87	0.08	<0.02	0.20	0.126	0.07	10.6	2.1	0.07	2500	2.73	<0.01
ZZ94323		1.22	17.2	3.22	5.95	0.05	0.02	0.13	0.033	0.05	15.1	14.9	0.22	342	4.08	0.01
ZZ94324		0.85	48.2	2.94	2.55	0.05	0.04	0.40	0.024	0.09	11.1	7.7	2.08	499	6.57	<0.01
ZZ94325		0.84	60.2	2.95	3.29	0.05	0.05	0.58	0.031	0.10	12.6	10.2	0.51	503	5.26	0.01
ZZ94326		1.02	49.7	3.35	3.92	0.07	0.04	0.50	0.030	0.09	14.2	12.2	0.55	1670	6.77	0.01
ZZ94327		0.96	46.0	3.44	3.53	0.05	0.05	0.41	0.030	0.11	12.3	11.0	0.48	457	4.78	<0.01
ZZ94328		0.95	41.3	2.62	4.62	0.08	<0.02	0.25	0.041	0.14	20.3	11.0	0.35	328	8.15	<0.01
ZZ94329		1.11	50.7	2.16	5.08	0.06	0.03	0.27	0.027	0.09	15.4	11.5	0.68	137	4.47	<0.01
ZZ94330		1.32	138.5	1.77	6.50	0.10	0.06	0.46	0.031	0.11	15.3	12.8	1.64	211	6.46	<0.01
ZZ94331		1.86	239	1.53	6.68	0.16	0.05	0.49	0.027	0.12	22.3	21.1	1.89	179	22.7	<0.01
ZZ94332		1.12	89.4	2.94	3.90	0.07	0.09	0.23	0.030	0.17	15.8	8.3	1.31	248	10.60	0.01
ZZ94333		0.76	66.6	2.86	4.08	0.07	0.06	0.31	0.027	0.14	17.7	12.6	0.50	385	5.44	0.01
ZZ94334		0.94	45.1	2.98	4.06	0.05	0.04	0.20	0.027	0.12	16.4	13.8	0.88	456	4.59	0.01
ZZ94335		0.95	46.8	2.74	3.71	0.05	0.04	0.15	0.029	0.12	13.9	13.7	0.70	237	5.87	0.01
ZZ94336		0.91	39.1	2.28	2.53	0.05	0.07	0.13	0.021	0.13	10.1	9.3	2.59	320	5.97	0.01
ZZ94337		0.70	42.0	2.29	2.78	<0.05	0.05	0.15	0.026	0.09	11.1	10.3	0.98	249	4.14	0.01
ZZ94338		0.56	23.2	2.09	2.89	<0.05	0.04	0.11	0.021	0.07	12.9	10.1	0.33	227	3.51	0.01
ZZ94339		0.83	27.6	2.87	3.88	0.11	0.06	0.13	0.034	0.08	56.2	12.0	0.47	333	4.83	0.01



ALS Canada Ltd.
 2103 Dollarton Hwy
 North Vancouver BC V7H 0A7
 Phone: 604 984 0221 Fax: 604 984 0218 www.alsglobal.com

To: ATAC RESOURCES LTD.
 C/O ARCHER, CATHRO & ASSOCIATES (1981)
 LIMITED
 1016-510 W HASTINGS ST
 VANCOUVER BC V6B 1L8

Page: 5 - C
 Total # Pages: 8 (A - D)
 Plus Appendix Pages
 Finalized Date: 26-SEP-2014
 Account: RCM

Project: Area G & H

CERTIFICATE OF ANALYSIS WH14146244

Sample Description	Method	ME-MS41	ME-MS41	ME-MS41	ME-MS41	ME-MS41	ME-MS41	ME-MS41	ME-MS41	ME-MS41	ME-MS41	ME-MS41	ME-MS41	ME-MS41	ME-MS41	
	Analyte	Nb	Ni	P	Pb	Rb	Re	S	Sb	Sc	Se	Sn	Sr	Ta	Te	Th
Units		ppm	ppm	ppm	ppm	ppm	ppm	%	ppm	ppm	ppm	ppm	ppm	ppm	ppm	ppm
LOR		0.05	0.2	10	0.2	0.1	0.001	0.01	0.05	0.1	0.2	0.2	0.2	0.01	0.01	0.2
ZZ94300		0.56	30.6	2180	31.9	10.3	0.006	0.07	2.56	3.1	3.1	0.5	79.9	<0.01	0.09	2.5
ZZ94301		0.59	83.6	2300	28.7	9.7	0.010	0.08	3.91	3.6	4.9	0.4	105.5	<0.01	0.08	2.6
ZZ94302		0.55	142.5	2620	30.5	9.2	0.002	0.06	7.13	4.5	3.4	0.5	127.5	<0.01	0.10	3.3
ZZ94303		0.60	130.0	1760	22.6	10.4	0.001	0.09	7.93	4.8	4.0	0.5	137.0	<0.01	0.14	3.3
ZZ94304		0.59	100.0	1690	20.0	8.5	0.005	0.08	6.37	3.9	3.2	0.5	112.0	<0.01	0.13	2.4
ZZ94305		0.61	81.6	2230	31.5	9.5	0.002	0.03	2.99	4.1	2.5	0.6	92.0	<0.01	0.10	2.4
ZZ94306		0.74	74.8	1850	24.9	8.7	0.002	0.04	3.18	4.4	2.0	0.5	78.9	<0.01	0.08	3.4
ZZ94307		0.43	75.4	1400	19.2	7.9	0.001	0.05	3.29	3.5	2.0	0.4	125.5	<0.01	0.06	2.6
ZZ94308		0.42	62.6	960	17.7	7.9	0.001	0.05	2.21	2.9	2.0	0.4	51.8	<0.01	0.05	1.0
ZZ94309		0.35	39.7	1110	13.8	6.8	0.001	0.05	1.44	2.4	1.1	0.3	57.0	<0.01	0.05	1.3
ZZ94310		0.56	48.1	1470	22.0	5.1	0.001	0.09	1.68	1.8	2.2	0.4	40.6	<0.01	0.06	0.5
ZZ94311		0.39	34.6	1140	20.5	8.0	0.001	0.02	1.88	2.5	1.5	0.4	32.0	<0.01	0.06	2.9
ZZ94312		0.30	48.6	870	15.2	5.7	0.001	0.04	1.96	2.6	1.7	0.3	95.7	<0.01	0.05	1.6
ZZ94313		0.45	44.3	1000	15.0	5.5	0.010	0.09	1.91	2.4	3.2	0.3	50.3	<0.01	0.05	1.6
ZZ94314		0.59	80.6	1610	28.7	7.1	0.001	0.04	3.35	6.0	2.7	0.4	65.6	0.01	0.06	3.1
ZZ94315		0.30	37.3	770	20.0	4.7	0.002	0.04	1.61	3.7	1.1	0.3	157.0	<0.01	0.04	2.3
ZZ94316		0.25	51.0	1010	22.2	4.3	0.002	0.08	2.27	3.4	3.0	0.3	54.5	<0.01	0.05	1.1
ZZ94317		0.48	37.0	930	19.2	10.1	0.001	0.08	1.16	4.2	1.3	0.2	57.8	<0.01	0.04	1.8
ZZ94318		0.94	28.8	550	19.5	10.1	0.001	0.11	0.74	4.1	1.4	0.4	40.0	<0.01	0.04	2.9
ZZ94319		0.66	29.5	830	21.9	9.3	<0.001	0.05	1.22	4.3	1.0	0.4	47.4	<0.01	0.03	1.7
ZZ94320		0.83	69.7	1480	103.0	7.0	0.001	0.05	7.48	7.1	3.0	0.4	87.1	<0.01	0.07	3.1
ZZ94321		0.28	38.3	690	89.7	8.6	0.001	0.02	6.19	2.8	1.6	0.6	9.3	<0.01	0.04	0.5
ZZ94322		0.60	24.6	1020	118.5	8.3	0.001	0.12	98.1	9.0	5.9	0.6	41.8	0.01	0.09	1.6
ZZ94323		1.11	37.3	770	133.0	9.7	<0.001	0.02	3.44	2.6	1.5	0.7	24.6	<0.01	0.05	3.0
ZZ94324		0.43	86.4	1350	65.4	6.4	0.002	0.07	4.84	3.9	2.8	0.3	98.9	<0.01	0.08	3.4
ZZ94325		0.58	92.4	1520	93.8	7.4	0.003	0.08	4.70	4.1	3.2	0.4	80.2	<0.01	0.06	2.2
ZZ94326		0.78	111.5	1540	70.5	8.1	0.002	0.07	3.52	4.7	3.6	0.4	77.9	<0.01	0.07	2.4
ZZ94327		0.65	71.2	1390	59.2	8.0	0.002	0.06	3.22	4.4	3.0	0.4	64.6	<0.01	0.09	3.2
ZZ94328		0.46	65.7	4960	18.8	14.7	0.004	0.18	4.24	3.0	3.9	1.2	243	<0.01	0.12	1.6
ZZ94329		0.73	92.4	2910	17.8	11.3	0.006	0.08	5.24	3.5	5.8	0.7	106.5	<0.01	0.11	2.2
ZZ94330		0.61	235	4270	12.3	15.7	0.004	0.08	8.45	5.7	8.6	0.7	248	<0.01	0.17	2.2
ZZ94331		0.75	411	6410	10.2	17.3	0.007	0.14	12.10	5.9	13.6	0.6	286	<0.01	0.22	2.6
ZZ94332		0.52	119.0	2100	18.7	11.8	0.002	0.09	9.51	4.6	5.9	0.6	126.0	<0.01	0.17	3.7
ZZ94333		0.56	109.0	1930	19.3	9.5	0.001	0.08	3.88	6.0	2.3	0.4	80.7	<0.01	0.07	3.1
ZZ94334		0.52	71.3	1240	22.6	9.0	0.001	0.07	2.89	4.8	2.0	0.5	66.2	<0.01	0.06	3.2
ZZ94335		0.52	74.1	1050	18.2	8.9	0.002	0.10	3.09	3.8	2.3	0.5	70.1	<0.01	0.08	2.8
ZZ94336		0.26	63.4	1060	14.5	7.8	0.001	0.10	2.95	3.2	2.0	0.3	135.0	<0.01	0.07	2.5
ZZ94337		0.34	62.0	980	14.9	6.3	0.003	0.11	2.84	2.9	2.8	0.4	68.7	<0.01	0.08	1.9
ZZ94338		0.48	45.3	1090	14.2	6.0	0.001	0.08	1.55	2.2	1.9	0.3	42.4	<0.01	0.05	1.3
ZZ94339		0.40	104.0	1210	15.1	8.1	0.001	0.03	2.48	5.7	2.2	0.5	44.5	<0.01	0.06	2.2



ALS Canada Ltd.
 2103 Dollarton Hwy
 North Vancouver BC V7H 0A7
 Phone: 604 984 0221 Fax: 604 984 0218 www.alsglobal.com

To: ATAC RESOURCES LTD.
 C/O ARCHER, CATHRO & ASSOCIATES (1981)
 LIMITED
 1016-510 W HASTINGS ST
 VANCOUVER BC V6B 1L8

Page: 5 - D
 Total # Pages: 8 (A - D)
 Plus Appendix Pages
 Finalized Date: 26-SEP-2014
 Account: RCM

Project: Area G & H

CERTIFICATE OF ANALYSIS WH14146244

Sample Description	Method	ME-MS41	ME-MS41	ME-MS41	ME-MS41	ME-MS41	ME-MS41	ME-MS41	ME-MS41
	Analyte	Ti	Ti	U	V	W	Y	Zn	Zr
Units		%	ppm	ppm	ppm	ppm	ppm	ppm	ppm
LOR		0.005	0.02	0.05	1	0.05	0.05	2	0.5
ZZ94300		0.009	0.51	3.40	305	0.16	12.55	194	1.0
ZZ94301		0.012	0.57	2.94	259	0.19	15.15	489	1.6
ZZ94302		0.016	0.65	3.28	377	0.21	21.3	954	2.7
ZZ94303		0.015	0.94	2.74	367	0.30	21.2	793	3.1
ZZ94304		0.014	0.58	2.70	235	0.24	17.85	594	3.0
ZZ94305		0.014	0.52	3.81	306	0.19	21.2	556	1.7
ZZ94306		0.017	0.44	2.05	206	0.21	16.45	423	2.4
ZZ94307		0.010	0.45	1.80	120	0.14	14.95	350	2.3
ZZ94308		0.009	0.24	1.59	80	0.11	15.60	186	1.4
ZZ94309		0.010	0.20	1.30	62	0.15	10.90	159	1.5
ZZ94310		0.013	0.23	2.13	124	0.22	17.75	231	0.9
ZZ94311		0.006	0.32	1.59	95	0.15	9.34	235	1.5
ZZ94312		0.007	0.29	1.36	58	0.11	10.75	193	1.9
ZZ94313		0.011	0.28	2.05	61	0.18	11.95	211	1.8
ZZ94314		0.013	0.50	2.84	121	0.16	23.2	410	2.2
ZZ94315		0.008	0.20	1.40	48	0.08	10.65	149	1.7
ZZ94316		0.005	0.14	1.74	46	0.06	14.75	158	1.8
ZZ94317		0.009	0.18	2.61	53	0.08	10.55	156	1.6
ZZ94318		0.020	0.14	6.52	49	0.15	9.75	95	1.7
ZZ94319		0.014	0.18	1.87	56	0.16	11.95	219	1.2
ZZ94320		0.016	0.30	2.46	66	0.11	15.95	638	1.1
ZZ94321		0.018	0.27	1.09	38	0.17	5.92	258	<0.5
ZZ94322		0.022	0.36	3.74	61	0.23	11.05	289	<0.5
ZZ94323		0.021	0.24	1.48	110	0.40	7.79	436	0.8
ZZ94324		0.009	0.32	1.63	88	0.12	11.55	411	2.0
ZZ94325		0.009	0.27	2.70	103	0.14	13.15	477	1.9
ZZ94326		0.011	0.27	2.87	114	0.12	14.40	481	1.6
ZZ94327		0.008	0.26	2.27	107	0.15	12.05	335	2.4
ZZ94328		0.015	0.69	4.83	274	0.29	17.05	431	0.5
ZZ94329		0.021	0.68	4.65	572	0.34	15.95	608	1.2
ZZ94330		0.032	0.75	8.21	743	0.27	26.6	1240	3.2
ZZ94331		0.039	1.65	16.55	1140	0.41	50.3	2870	3.6
ZZ94332		0.013	0.87	2.66	278	0.34	17.75	618	4.7
ZZ94333		0.021	0.50	2.28	215	0.24	21.1	479	2.0
ZZ94334		0.014	0.51	1.59	121	0.17	17.40	318	1.8
ZZ94335		0.010	0.53	1.31	109	0.19	14.10	346	2.1
ZZ94336		0.006	0.57	1.54	76	0.11	12.75	266	3.9
ZZ94337		0.005	0.39	1.45	96	0.16	12.60	307	2.1
ZZ94338		0.010	0.25	1.90	63	0.15	11.45	226	1.4
ZZ94339		0.006	0.38	2.06	98	0.19	45.9	375	2.1



ALS Canada Ltd.
 2103 Dollarton Hwy
 North Vancouver BC V7H 0A7
 Phone: 604 984 0221 Fax: 604 984 0218 www.alsglobal.com

To: ATAC RESOURCES LTD.
 C/O ARCHER, CATHRO & ASSOCIATES (1981)
 LIMITED
 1016-510 W HASTINGS ST
 VANCOUVER BC V6B 1L8

Page: 6 - D
 Total # Pages: 8 (A - D)
 Plus Appendix Pages
 Finalized Date: 26-SEP-2014
 Account: RCM

Project: Area G & H

CERTIFICATE OF ANALYSIS WH14146244

Sample Description	Method	ME-MS41	ME-MS41	ME-MS41	ME-MS41	ME-MS41	ME-MS41	ME-MS41	ME-MS41
	Analyte	Ti	Ti	U	V	W	Y	Zn	Zr
Units		%	ppm	ppm	ppm	ppm	ppm	ppm	ppm
LOR		0.005	0.02	0.05	1	0.05	0.05	2	0.5
ZZ94340		0.042	0.19	0.64	80	0.25	2.93	68	1.8
ZZ94341		0.007	0.68	3.51	91	0.19	16.40	424	1.9
ZZ94342		0.008	0.32	2.15	51	0.10	12.15	704	2.0
ZZ94343		0.007	0.15	1.13	34	0.06	9.20	113	1.2
ZZ94344		0.010	0.16	0.95	38	0.11	9.60	114	1.2
ZZ94345		0.011	0.20	1.06	39	0.07	10.75	233	2.0
ZZ94346		<0.005	0.12	0.54	13	0.13	11.25	124	1.0
ZZ94347		0.013	0.17	1.25	63	0.21	13.20	103	1.3
ZZ94348		0.023	0.16	1.42	54	0.21	14.60	93	1.7
ZZ94349		0.010	0.14	1.72	44	0.09	13.95	108	1.1
ZZ94350		0.005	0.10	1.76	30	<0.05	13.95	88	0.6
ZZ94351		0.006	0.15	0.80	26	0.05	9.73	168	1.3
ZZ94352		0.006	0.16	0.78	28	0.05	10.35	183	1.5
ZZ94353		0.007	0.18	0.96	28	0.05	10.85	179	1.4
ZZ94354		0.006	0.17	1.05	28	0.06	11.30	192	1.8
ZZ94355		0.005	0.11	1.36	15	<0.05	15.50	78	1.4
ZZ94356		0.010	0.15	1.41	15	0.06	11.10	58	1.7
ZZ94357		<0.005	0.09	0.91	6	<0.05	9.58	49	1.5
ZZ94358		<0.005	0.08	0.61	6	<0.05	22.7	39	1.3
ZZ94359		<0.005	0.13	0.68	3	<0.05	11.05	136	3.8
ZZ94360		<0.005	0.08	0.81	8	<0.05	9.37	66	2.4
ZZ94361		<0.005	0.09	0.86	8	<0.05	11.25	71	1.9
ZZ94362		<0.005	0.07	0.67	7	0.05	10.25	95	1.5
ZZ94363		<0.005	0.08	3.07	7	<0.05	10.40	69	1.4
ZZ94364		<0.005	0.10	1.25	21	<0.05	11.95	89	1.6
ZZ94365		<0.005	0.05	1.54	21	<0.05	8.98	77	1.6
ZZ94366		0.012	0.17	1.45	54	0.12	10.80	216	1.4
ZZ94367		<0.005	0.20	0.65	72	0.07	3.74	156	1.4
ZZ94368		<0.005	0.19	2.06	35	<0.05	11.85	437	4.3
ZZ94369		<0.005	0.11	1.74	29	<0.05	9.74	208	4.8
ZZ94370		<0.005	0.10	1.23	22	<0.05	6.89	126	2.6
ZZ94371		0.063	0.32	1.28	139	0.16	10.45	212	1.9
ZZ94372		0.097	0.31	1.04	189	0.17	11.85	264	2.3
ZZ94373		0.011	0.42	3.35	219	0.13	12.30	347	1.6
ZZ94374		0.009	0.53	3.12	188	0.17	13.05	410	2.0
ZZ94375		0.005	0.28	3.28	89	0.12	11.20	298	2.5
ZZ94376		<0.005	0.07	1.95	19	<0.05	8.01	106	3.4
ZZ94377		<0.005	0.06	1.14	17	<0.05	7.85	111	3.8
ZZ94378		0.019	0.16	0.89	57	0.21	16.10	89	0.9
ZZ94379		0.010	0.20	1.02	47	0.12	11.05	99	2.3



ALS Canada Ltd.
 2103 Dollarton Hwy
 North Vancouver BC V7H 0A7
 Phone: 604 984 0221 Fax: 604 984 0218 www.alsglobal.com

To: ATAC RESOURCES LTD.
 C/O ARCHER, CATHRO & ASSOCIATES (1981)
 LIMITED
 1016-510 W HASTINGS ST
 VANCOUVER BC V6B 1L8

Page: 7 - D
 Total # Pages: 8 (A - D)
 Plus Appendix Pages
 Finalized Date: 26-SEP-2014
 Account: RCM

Project: Area G & H

CERTIFICATE OF ANALYSIS WH14146244

Sample Description	Method Analyte Units LOR	ME-MS41	ME-MS41	ME-MS41	ME-MS41	ME-MS41	ME-MS41	ME-MS41	ME-MS41
		Ti %	Ti ppm	U ppm	V ppm	W ppm	Y ppm	Zn ppm	Zr ppm
		0.005	0.02	0.05	1	0.05	0.05	2	0.5
ZZ94380		0.020	0.13	1.33	48	0.27	10.95	92	1.7
ZZ94381		0.007	0.16	1.27	50	0.09	13.70	124	1.4
ZZ94382		0.006	0.14	1.22	31	<0.05	9.76	112	2.0
ZZ94383		0.009	0.23	1.22	43	0.11	13.55	142	1.8
ZZ94384		0.006	0.23	1.23	44	0.05	13.30	129	2.8
ZZ94385		0.013	0.16	3.88	44	0.09	11.50	112	2.4
ZZ94386		0.009	0.08	1.00	24	0.06	7.72	80	1.4
ZZ94387		0.009	0.10	0.95	22	0.12	9.71	80	1.7
ZZ94388		0.012	0.12	1.62	25	0.08	9.29	114	1.5
ZZ94389		0.013	0.12	0.99	26	0.11	8.48	102	1.0
ZZ94390		0.019	0.13	1.04	49	0.14	9.87	104	0.8
ZZ94391		0.017	0.15	0.74	31	0.10	10.45	81	0.9
ZZ94392		0.012	0.14	0.77	44	0.10	13.70	88	1.2
ZZ94393		0.016	0.15	0.70	43	0.11	11.10	95	1.4
ZZ94394		0.008	0.11	0.82	18	0.05	6.20	71	1.0
ZZ94395		0.018	0.40	0.43	52	0.12	9.66	125	1.3
ZZ94396		0.021	0.21	0.34	59	0.13	14.45	64	2.1
ZZ94397		0.015	0.15	0.54	50	0.14	15.00	66	1.8
ZZ94398		0.019	0.15	0.56	56	0.16	18.25	111	2.1
ZZ94399		0.007	0.09	0.77	22	0.06	6.72	88	1.3
ZZ94400		0.015	0.11	0.79	31	0.14	8.51	88	1.2
ZZ94401		0.026	0.12	0.82	49	0.22	10.45	104	1.0
ZZ94402		0.030	0.11	1.22	51	0.27	9.79	70	0.8
ZZ94403		0.010	0.12	0.94	39	0.06	11.90	91	1.0
ZZ94404		0.014	0.09	0.81	35	0.06	11.00	84	1.2
ZZ94405		0.013	0.07	0.72	35	0.07	10.60	81	1.3
ZZ94406		0.008	0.13	0.91	20	0.05	7.76	96	1.8
ZZ94407		0.007	0.12	0.88	16	<0.05	5.83	88	3.3
ZZ94408		0.008	0.11	0.92	17	<0.05	6.55	89	3.1
ZZ94409		0.009	0.11	0.74	24	0.08	7.60	100	1.3
ZZ94410		0.007	0.11	0.89	16	0.05	6.06	86	2.4
ZZ94411		0.007	0.14	0.90	17	0.07	6.09	83	2.2
ZZ94412		0.008	0.07	0.82	14	<0.05	5.11	58	1.6
ZZ94413		0.008	0.10	0.89	18	0.19	6.44	90	1.4
ZZ94414		0.008	0.09	0.76	18	0.05	6.42	74	1.3
ZZ94415		0.007	0.08	0.74	14	0.05	6.18	82	1.9
ZZ94416		0.021	0.10	0.90	33	0.18	6.53	106	0.9
ZZ94417		0.010	0.12	0.98	32	0.11	15.80	110	2.7
ZZ94418		0.015	0.10	0.88	40	0.13	12.70	93	1.6
ZZ94419		0.012	0.12	0.79	27	0.08	11.15	73	1.1



ALS Canada Ltd.
 2103 Dollarton Hwy
 North Vancouver BC V7H 0A7
 Phone: 604 984 0221 Fax: 604 984 0218 www.alsglobal.com

To: ATAC RESOURCES LTD.
 C/O ARCHER, CATHRO & ASSOCIATES (1981)
 LIMITED
 1016-510 W HASTINGS ST
 VANCOUVER BC V6B 1L8

Page: 8 - A
 Total # Pages: 8 (A - D)
 Plus Appendix Pages
 Finalized Date: 26-SEP-2014
 Account: RCM

Project: Area G & H

CERTIFICATE OF ANALYSIS WH14146244

Sample Description	Method Analyte Units LOR	WEI-21 Recvd Wt. kg	Au-ICP21 Au ppm	ME-MS41 Ag ppm	ME-MS41 Al %	ME-MS41 As ppm	ME-MS41 Au ppm	ME-MS41 B ppm	ME-MS41 Ba ppm	ME-MS41 Be ppm	ME-MS41 Bi ppm	ME-MS41 Ca %	ME-MS41 Cd ppm	ME-MS41 Ce ppm	ME-MS41 Co ppm	ME-MS41 Cr ppm
		0.02	0.001	0.01	0.01	0.1	0.2	10	10	0.05	0.01	0.01	0.01	0.02	0.1	1
ZZ94420		0.26	0.001	0.30	0.88	13.3	<0.2	<10	140	0.65	0.14	8.52	0.36	16.60	7.9	15
ZZ94421		0.28	0.001	0.16	0.87	12.6	<0.2	<10	140	0.60	0.11	9.66	0.27	16.70	7.5	16
ZZ94422		0.28	0.003	0.22	1.29	13.6	<0.2	<10	260	0.62	0.18	2.44	0.21	25.1	9.7	24
ZZ94423		0.26	<0.001	0.16	0.83	10.6	<0.2	<10	190	0.53	0.13	4.94	0.51	18.20	8.4	18
ZZ94424		0.29	0.001	0.12	1.06	13.1	<0.2	<10	180	0.53	0.18	1.49	0.33	24.2	12.7	27
ZZ94425		0.47	<0.001	0.15	0.64	7.6	<0.2	<10	90	0.44	0.11	10.35	0.38	14.15	6.2	15
ZZ94426		0.40	0.002	0.11	0.63	9.1	<0.2	<10	140	0.47	0.08	12.85	0.31	13.70	6.1	12
ZZ94427		0.35	<0.001	0.12	0.56	8.2	<0.2	<10	110	0.39	0.07	14.75	0.43	11.85	5.7	11
ZZ94428		0.29	0.001	0.15	0.76	10.7	<0.2	<10	110	0.50	0.12	8.65	0.33	14.70	5.7	15
ZZ94429		0.29	0.001	0.18	0.72	9.8	<0.2	<10	200	0.60	0.21	1.75	0.39	19.00	7.6	18

***** See Appendix Page for comments regarding this certificate *****



ALS Canada Ltd.
 2103 Dollarton Hwy
 North Vancouver BC V7H 0A7
 Phone: 604 984 0221 Fax: 604 984 0218 www.alsglobal.com

To: ATAC RESOURCES LTD.
 C/O ARCHER, CATHRO & ASSOCIATES (1981)
 LIMITED
 1016-510 W HASTINGS ST
 VANCOUVER BC V6B 1L8

Page: 8 - B
 Total # Pages: 8 (A - D)
 Plus Appendix Pages
 Finalized Date: 26-SEP-2014
 Account: RCM

Project: Area G & H

CERTIFICATE OF ANALYSIS WH14146244

Sample Description	Method Analyte Units LOR	ME-MS41	ME-MS41	ME-MS41	ME-MS41	ME-MS41	ME-MS41	ME-MS41	ME-MS41	ME-MS41	ME-MS41	ME-MS41	ME-MS41	ME-MS41	ME-MS41	
		Cs ppm	Cu ppm	Fe %	Ga ppm	Ge ppm	Hf ppm	Hg ppm	In ppm	K %	La ppm	Li ppm	Mg %	Mn ppm	Mo ppm	Na %
		0.05	0.2	0.01	0.05	0.05	0.02	0.01	0.005	0.01	0.2	0.1	0.01	5	0.05	0.01
ZZ94420		0.72	18.8	2.32	2.38	<0.05	0.05	0.08	0.020	0.08	8.6	7.1	4.96	619	1.13	0.01
ZZ94421		0.70	16.0	2.21	2.47	0.05	0.07	0.08	0.021	0.09	10.3	6.9	5.61	452	1.12	0.01
ZZ94422		0.66	22.0	2.71	3.93	<0.05	0.05	0.08	0.028	0.06	13.1	12.3	1.56	458	0.98	0.01
ZZ94423		0.69	20.8	2.10	2.47	<0.05	0.04	0.09	0.021	0.07	9.0	8.2	2.55	551	1.01	0.01
ZZ94424		0.88	16.9	2.66	3.38	0.05	0.04	0.06	0.026	0.09	11.5	12.5	0.61	535	1.41	0.01
ZZ94425		0.87	14.9	1.94	1.85	<0.05	0.05	0.10	0.021	0.08	6.7	7.2	5.14	341	0.83	0.01
ZZ94426		0.66	14.4	1.73	1.84	<0.05	0.03	0.09	0.015	0.08	6.9	5.8	6.48	406	0.99	0.01
ZZ94427		0.66	12.4	1.58	1.51	<0.05	0.04	0.10	0.016	0.08	5.7	5.1	7.17	394	0.92	0.01
ZZ94428		0.74	15.3	2.10	2.12	<0.05	0.04	0.06	0.021	0.07	7.2	7.5	4.92	240	1.32	0.01
ZZ94429		0.89	28.2	1.85	2.12	<0.05	0.06	0.09	0.029	0.07	9.3	6.0	0.59	124	1.67	<0.01

***** See Appendix Page for comments regarding this certificate *****



ALS Canada Ltd.
 2103 Dollarton Hwy
 North Vancouver BC V7H 0A7
 Phone: 604 984 0221 Fax: 604 984 0218 www.alsglobal.com

To: ATAC RESOURCES LTD.
 C/O ARCHER, CATHRO & ASSOCIATES (1981)
 LIMITED
 1016-510 W HASTINGS ST
 VANCOUVER BC V6B 1L8

Page: 8 - C
 Total # Pages: 8 (A - D)
 Plus Appendix Pages
 Finalized Date: 26-SEP-2014
 Account: RCM

Project: Area G & H

CERTIFICATE OF ANALYSIS WH14146244

Sample Description	Method Analyte Units LOR	ME-MS41	ME-MS41	ME-MS41	ME-MS41	ME-MS41	ME-MS41	ME-MS41	ME-MS41	ME-MS41	ME-MS41	ME-MS41	ME-MS41	ME-MS41	ME-MS41	
		Nb ppm	Ni ppm	P ppm	Pb ppm	Rb ppm	Re ppm	S %	Sb ppm	Sc ppm	Se ppm	Sn ppm	Sr ppm	Ta ppm	Te ppm	Th ppm
		0.05	0.2	10	0.2	0.1	0.001	0.01	0.05	0.1	0.2	0.2	0.2	0.01	0.01	0.2
ZZ94420		0.26	17.0	700	42.1	6.6	<0.001	0.04	1.84	3.1	0.8	0.2	45.9	<0.01	0.01	1.1
ZZ94421		0.31	17.8	540	26.4	6.7	<0.001	0.03	1.07	3.9	0.9	0.3	53.8	<0.01	0.02	1.6
ZZ94422		0.66	23.3	580	22.6	6.5	<0.001	0.03	1.03	3.8	0.9	0.4	24.3	<0.01	0.03	2.0
ZZ94423		0.42	20.0	680	24.7	6.1	<0.001	0.07	1.16	2.3	1.1	0.3	45.5	<0.01	0.02	0.8
ZZ94424		0.57	21.7	580	29.6	8.5	0.001	0.07	0.83	3.4	1.3	0.3	32.3	<0.01	0.02	1.3
ZZ94425		0.26	15.4	540	25.6	6.4	0.001	0.07	0.72	2.8	1.0	0.2	71.5	<0.01	0.02	1.6
ZZ94426		0.23	15.3	400	20.7	5.1	<0.001	0.01	0.87	2.9	0.6	0.2	84.3	<0.01	0.01	1.6
ZZ94427		0.17	14.2	410	23.0	5.0	<0.001	0.01	0.88	2.7	0.6	0.2	98.0	<0.01	0.01	1.4
ZZ94428		0.28	16.8	610	25.7	6.3	<0.001	0.05	0.97	2.9	0.8	0.2	49.7	<0.01	0.02	1.3
ZZ94429		0.31	22.6	560	30.7	5.6	0.001	0.13	0.90	3.5	0.9	0.3	21.7	<0.01	0.02	2.9

***** See Appendix Page for comments regarding this certificate *****



ALS Canada Ltd.
 2103 Dollarton Hwy
 North Vancouver BC V7H 0A7
 Phone: 604 984 0221 Fax: 604 984 0218 www.alsglobal.com

To: ATAC RESOURCES LTD.
 C/O ARCHER, CATHRO & ASSOCIATES (1981)
 LIMITED
 1016-510 W HASTINGS ST
 VANCOUVER BC V6B 1L8

Page: 8 - D
 Total # Pages: 8 (A - D)
 Plus Appendix Pages
 Finalized Date: 26-SEP-2014
 Account: RCM

Project: Area G & H

CERTIFICATE OF ANALYSIS WH14146244

Sample Description	Method Analyte Units LOR	ME-MS41	ME-MS41	ME-MS41	ME-MS41	ME-MS41	ME-MS41	ME-MS41	ME-MS41
		Ti %	Ti ppm	U ppm	V ppm	W ppm	Y ppm	Zn ppm	Zr ppm
		0.005	0.02	0.05	1	0.05	0.05	2	0.5
ZZ94420		0.008	0.09	0.88	25	0.08	9.43	119	1.5
ZZ94421		0.009	0.13	0.89	26	0.08	12.15	78	2.1
ZZ94422		0.024	0.09	0.69	40	0.25	10.45	96	1.3
ZZ94423		0.013	0.12	2.08	27	0.12	8.39	106	1.1
ZZ94424		0.016	0.18	2.72	36	0.10	8.00	117	1.3
ZZ94425		0.008	0.13	1.06	19	0.05	7.09	101	1.6
ZZ94426		0.008	0.10	0.98	20	0.06	7.55	65	1.2
ZZ94427		0.006	0.10	1.01	17	0.08	6.22	88	1.3
ZZ94428		0.008	0.12	1.21	23	0.06	7.62	111	1.4
ZZ94429		0.005	0.19	2.54	24	0.07	8.61	106	2.5



ALS Canada Ltd.
 2103 Dollarton Hwy
 North Vancouver BC V7H 0A7
 Phone: 604 984 0221 Fax: 604 984 0218 www.alsglobal.com

To: ATAC RESOURCES LTD.
 C/O ARCHER, CATHRO & ASSOCIATES (1981)
 LIMITED
 1016-510 W HASTINGS ST
 VANCOUVER BC V6B 1L8

Page: Appendix 1
 Total # Appendix Pages: 1
 Finalized Date: 26-SEP-2014
 Account: RCM

Project: Area G & H

CERTIFICATE OF ANALYSIS WH14146244

CERTIFICATE COMMENTS	
	ANALYTICAL COMMENTS
Applies to Method:	Gold determinations by this method are semi-quantitative due to the small sample weight used (0.5g). ME-MS41
	LABORATORY ADDRESSES
Applies to Method:	Processed at ALS Whitehorse located at 78 Mt. Sima Rd, Whitehorse, YT, Canada. LOG-22 SCR-41 WEI-21
Applies to Method:	Processed at ALS Vancouver located at 2103 Dollarton Hwy, North Vancouver, BC, Canada. Au-ICP21 ME-MS41



ALS Canada Ltd.
 2103 Dollarton Hwy
 North Vancouver BC V7H 0A7
 Phone: 604 984 0221 Fax: 604 984 0218 www.alsglobal.com

To: ATAC RESOURCES LTD.
 C/O ARCHER, CATHRO & ASSOCIATES (1981)
 LIMITED
 1016-510 W HASTINGS ST
 VANCOUVER BC V6B 1L8

Page: 1
 Total # Pages: 9 (A - D)
 Plus Appendix Pages
 Finalized Date: 28-SEP-2014
 Account: RCM

CERTIFICATE WH14146242

Project: Area G & H

This report is for 290 Soil samples submitted to our lab in Whitehorse, YT, Canada on 16-SEP-2014.

The following have access to data associated with this certificate:

ROB CARNE	JULIA LANE	JOAN MARIACHER
-----------	------------	----------------

SAMPLE PREPARATION	
ALS CODE	DESCRIPTION
WEI-21	Received Sample Weight
LOG-22	Sample login - Rcd w/o BarCode
SCR-41	Screen to -180um and save both

ANALYTICAL PROCEDURES		
ALS CODE	DESCRIPTION	INSTRUMENT
Au-ICP21	Au 30g FA ICP-AES Finish	ICP-AES
ME-MS41	51 anal. aqua regia ICPMS	

To: ATAC RESOURCES LTD.
 ATTN: JULIA LANE
 C/O ARCHER, CATHRO & ASSOCIATES (1981) LIMITED
 1016-510 W HASTINGS ST
 VANCOUVER BC V6B 1L8

This is the Final Report and supersedes any preliminary report with this certificate number. Results apply to samples as submitted. All pages of this report have been checked and approved for release.

***** See Appendix Page for comments regarding this certificate *****

Signature: 
 Colin Ramshaw, Vancouver Laboratory Manager



ALS Canada Ltd.
 2103 Dollarton Hwy
 North Vancouver BC V7H 0A7
 Phone: 604 984 0221 Fax: 604 984 0218 www.alsglobal.com

To: ATAC RESOURCES LTD.
 C/O ARCHER, CATHRO & ASSOCIATES (1981)
 LIMITED
 1016-510 W HASTINGS ST
 VANCOUVER BC V6B 1L8

Page: 2 - B
 Total # Pages: 9 (A - D)
 Plus Appendix Pages
 Finalized Date: 28-SEP-2014
 Account: RCM

Project: Area G & H

CERTIFICATE OF ANALYSIS WH14146242

Sample Description	Method Analyte Units LOR	ME-MS41	ME-MS41	ME-MS41	ME-MS41	ME-MS41	ME-MS41	ME-MS41	ME-MS41	ME-MS41	ME-MS41	ME-MS41	ME-MS41	ME-MS41	ME-MS41	
		Cs ppm	Cu ppm	Fe %	Ga ppm	Ge ppm	Hf ppm	Hg ppm	In ppm	K %	La ppm	Li ppm	Mg %	Mn ppm	Mo ppm	Na %
ZZ95001		0.70	25.2	1.90	1.99	<0.05	0.03	0.12	0.018	0.10	8.0	8.1	4.27	447	2.12	0.01
ZZ95002		0.71	17.9	2.96	4.37	0.06	0.04	0.10	0.026	0.06	17.0	16.8	0.60	492	1.27	0.01
ZZ95003		0.46	24.4	1.40	2.33	<0.05	0.05	0.12	0.018	0.05	8.6	14.3	3.56	176	0.72	0.01
ZZ95004		0.60	28.0	2.57	3.20	0.05	0.06	0.11	0.028	0.07	12.8	15.4	1.80	385	1.58	0.01
ZZ95005		0.69	22.7	1.84	1.92	<0.05	0.04	0.12	0.017	0.09	7.9	7.4	4.43	391	2.05	0.01
ZZ95006		1.03	14.5	2.74	4.91	<0.05	0.03	0.06	0.031	0.05	14.2	16.2	0.44	339	1.61	<0.01
ZZ95007		0.82	37.2	2.49	2.29	<0.05	0.04	0.16	0.025	0.08	8.3	11.6	3.05	405	2.58	<0.01
ZZ95008		0.78	26.0	1.98	2.49	<0.05	0.03	0.13	0.018	0.13	9.1	10.2	3.70	439	2.54	0.01
ZZ95009		0.79	24.2	1.75	2.10	<0.05	0.05	0.13	0.017	0.12	8.0	8.8	4.17	344	2.46	0.01
ZZ95010		0.82	26.6	2.02	2.69	<0.05	0.03	0.14	0.021	0.12	10.0	10.4	3.55	435	2.54	0.01
ZZ95011		0.87	81.8	2.91	2.27	0.05	0.08	0.30	0.040	0.07	12.6	12.8	0.28	194	9.03	<0.01
ZZ95012		0.89	76.6	2.53	2.44	0.06	0.05	0.36	0.050	0.07	13.0	12.5	0.34	862	5.23	<0.01
ZZ95013		0.69	58.2	2.74	2.09	0.06	0.05	0.36	0.040	0.05	11.2	11.7	0.34	458	7.85	<0.01
ZZ95014		0.77	53.6	1.98	2.74	0.05	0.05	0.28	0.034	0.08	13.7	11.3	0.27	287	4.92	<0.01
ZZ95015		0.71	52.3	2.52	2.74	0.05	0.06	0.25	0.026	0.08	13.0	9.3	0.23	136	4.57	<0.01
ZZ95016		0.83	44.5	2.13	3.85	0.05	0.04	0.21	0.027	0.11	13.9	9.8	0.37	431	8.24	<0.01
ZZ95017		0.76	35.5	1.76	3.52	0.05	0.05	0.24	0.024	0.09	16.8	8.8	0.37	222	4.11	<0.01
ZZ95018		0.75	53.2	3.36	3.34	0.08	0.06	0.30	0.034	0.10	30.9	8.1	0.35	467	16.05	<0.01
ZZ95019		0.78	88.8	2.90	3.89	0.06	0.05	0.48	0.038	0.07	17.5	12.1	0.50	295	8.66	<0.01
ZZ95020		0.72	48.0	1.85	3.07	0.06	0.06	0.23	0.029	0.08	16.1	11.4	1.07	608	4.76	<0.01
ZZ95021		0.35	30.0	1.36	1.87	<0.05	0.07	0.12	0.017	0.04	8.4	7.8	1.08	203	1.46	0.01
ZZ95022		0.53	23.6	2.11	2.47	<0.05	0.04	0.12	0.022	0.06	11.6	8.4	2.54	261	2.80	0.01
ZZ95023		0.66	24.1	2.26	3.07	<0.05	0.05	0.10	0.022	0.07	13.8	12.4	2.40	312	2.01	0.01
ZZ95024		0.55	27.2	2.43	3.10	<0.05	0.06	0.12	0.023	0.07	13.6	12.9	2.62	425	2.23	0.01
ZZ95025		0.60	22.1	1.76	1.89	<0.05	0.03	0.10	0.017	0.09	8.0	7.6	4.05	368	2.03	0.01
ZZ95026		0.59	29.8	2.02	2.35	<0.05	0.04	0.14	0.021	0.07	10.3	9.5	3.03	506	1.61	0.01
ZZ95027		1.94	64.2	3.42	4.92	0.05	<0.02	2.16	0.049	0.08	13.0	13.5	0.47	1060	9.95	<0.01
ZZ95028		0.57	103.0	2.74	2.32	0.07	0.07	0.50	0.034	0.16	10.4	4.1	0.05	93	155.0	<0.01
ZZ95029		1.58	40.3	2.22	5.26	<0.05	<0.02	0.10	0.019	0.04	11.4	7.9	0.11	204	6.24	<0.01
ZZ95030		2.01	89.2	2.39	4.93	0.06	0.02	0.33	0.032	0.07	13.6	12.2	0.32	202	14.00	<0.01
ZZ95031		3.92	161.0	1.61	4.95	0.07	0.02	0.51	0.023	0.10	15.1	16.8	1.14	249	14.10	<0.01
ZZ95032		2.66	102.5	1.54	4.66	0.06	<0.02	0.43	0.020	0.09	14.0	13.0	0.88	68	6.89	<0.01
ZZ95033		1.19	71.9	1.50	3.93	0.05	<0.02	0.66	0.026	0.09	14.1	10.3	0.43	90	3.62	<0.01
ZZ95034		1.25	73.2	1.88	4.08	0.06	0.02	0.70	0.023	0.09	14.1	11.6	0.42	124	3.82	<0.01
ZZ95035		1.24	56.5	2.07	4.02	0.06	<0.02	0.76	0.021	0.10	14.7	12.3	0.42	286	6.36	<0.01
ZZ95036		1.31	51.3	3.33	3.84	0.07	0.03	0.51	0.027	0.12	16.0	13.3	0.34	336	23.2	<0.01
ZZ95037		0.97	82.9	2.68	3.38	0.08	0.05	0.41	0.033	0.09	13.7	11.1	0.30	1380	12.65	<0.01
ZZ95038		0.95	71.1	2.65	3.03	0.06	0.05	0.41	0.033	0.10	15.0	10.6	0.31	1760	12.20	<0.01
ZZ95039		1.29	74.3	1.27	5.04	0.06	<0.02	0.38	0.022	0.06	15.9	10.9	1.06	104	1.28	<0.01
ZZ95040		1.44	84.3	0.66	6.46	0.09	<0.02	0.53	0.023	0.10	22.7	3.6	0.21	35	3.38	<0.01



ALS Canada Ltd.
 2103 Dollarton Hwy
 North Vancouver BC V7H 0A7
 Phone: 604 984 0221 Fax: 604 984 0218 www.alsglobal.com

To: ATAC RESOURCES LTD.
 C/O ARCHER, CATHRO & ASSOCIATES (1981)
 LIMITED
 1016-510 W HASTINGS ST
 VANCOUVER BC V6B 1L8

Page: 2 - C
 Total # Pages: 9 (A - D)
 Plus Appendix Pages
 Finalized Date: 28-SEP-2014
 Account: RCM

Project: Area G & H

CERTIFICATE OF ANALYSIS WH14146242

Sample Description	Method	ME-MS41	ME-MS41	ME-MS41	ME-MS41	ME-MS41	ME-MS41	ME-MS41	ME-MS41	ME-MS41	ME-MS41	ME-MS41	ME-MS41	ME-MS41	ME-MS41	
	Analyte	Nb	Ni	P	Pb	Rb	Re	S	Sb	Sc	Se	Sn	Sr	Ta	Te	Th
Units		ppm	ppm	ppm	ppm	ppm	ppm	%	ppm	ppm	ppm	ppm	ppm	ppm	ppm	ppm
LOR		0.05	0.2	10	0.2	0.1	0.001	0.01	0.05	0.1	0.2	0.2	0.2	0.01	0.01	0.2
ZZ95001		0.30	36.7	780	17.3	6.2	<0.001	0.02	1.35	3.0	1.0	0.2	136.0	<0.01	0.03	2.0
ZZ95002		0.89	36.0	400	16.9	7.1	<0.001	0.03	0.85	4.0	1.0	0.5	21.5	<0.01	0.04	2.7
ZZ95003		0.45	30.9	620	14.0	4.3	0.003	0.17	0.85	2.9	3.1	0.2	83.7	<0.01	0.03	2.2
ZZ95004		0.73	40.3	980	18.0	6.4	<0.001	0.04	1.11	4.0	1.4	0.3	43.6	<0.01	0.03	2.8
ZZ95005		0.36	37.1	840	15.8	5.9	<0.001	0.03	1.25	2.8	0.9	0.2	125.5	<0.01	0.04	1.9
ZZ95006		0.97	26.0	280	17.6	7.8	<0.001	0.02	0.66	3.4	0.6	0.6	14.9	<0.01	0.04	3.5
ZZ95007		0.42	45.4	940	20.3	5.4	0.001	0.05	1.35	3.3	1.5	0.3	92.0	<0.01	0.05	2.3
ZZ95008		0.37	48.7	940	18.5	7.8	0.001	0.04	1.47	2.7	1.5	0.3	120.0	<0.01	0.04	1.3
ZZ95009		0.34	41.1	850	15.1	7.0	<0.001	0.03	1.35	2.8	1.0	0.2	172.0	<0.01	0.03	2.1
ZZ95010		0.41	46.9	810	17.8	7.7	<0.001	0.03	1.43	3.1	1.0	0.3	136.0	<0.01	0.03	1.6
ZZ95011		0.50	131.0	1440	115.5	6.0	0.005	0.06	7.78	3.9	5.0	0.4	84.4	<0.01	0.09	4.2
ZZ95012		0.49	109.5	1700	98.8	6.1	0.008	0.07	5.46	4.3	3.8	0.4	118.5	<0.01	0.08	3.8
ZZ95013		0.27	104.5	2020	71.2	5.5	0.004	0.07	6.58	3.9	3.6	0.3	116.0	<0.01	0.07	2.1
ZZ95014		0.55	69.6	1580	55.1	7.1	0.004	0.05	4.99	3.2	3.3	0.4	66.8	<0.01	0.09	3.0
ZZ95015		0.57	67.7	1670	20.5	7.6	0.003	0.06	3.86	3.0	3.3	0.4	57.1	<0.01	0.11	2.2
ZZ95016		0.58	97.2	1880	24.6	9.9	0.003	0.06	4.89	3.3	2.6	0.5	93.5	<0.01	0.11	1.7
ZZ95017		0.61	62.3	1530	20.0	8.5	0.004	0.06	2.85	3.8	3.1	0.5	73.2	<0.01	0.09	2.2
ZZ95018		0.60	120.0	1850	24.3	8.1	<0.001	0.05	4.31	8.6	3.0	0.8	69.3	<0.01	0.12	3.7
ZZ95019		0.64	119.5	1900	33.5	8.1	0.006	0.05	5.39	5.7	4.0	0.5	58.9	<0.01	0.10	2.3
ZZ95020		0.79	81.7	1390	29.1	7.7	0.008	0.07	2.90	3.8	6.2	0.4	64.8	<0.01	0.08	2.7
ZZ95021		0.48	29.4	610	14.0	3.6	0.011	0.30	1.74	2.3	4.5	0.2	57.5	<0.01	0.03	1.5
ZZ95022		0.39	44.2	930	17.5	5.8	<0.001	0.04	1.57	3.1	1.5	0.3	75.9	<0.01	0.04	1.4
ZZ95023		0.67	37.0	1010	17.1	6.7	<0.001	0.03	1.21	3.7	1.2	0.4	54.1	<0.01	0.04	2.4
ZZ95024		0.69	38.7	800	18.5	6.4	<0.001	0.02	1.26	4.0	1.0	0.4	48.4	<0.01	0.03	3.0
ZZ95025		0.35	36.1	890	16.0	5.5	<0.001	0.04	1.31	2.4	1.2	0.2	126.5	<0.01	0.03	1.2
ZZ95026		0.45	44.3	950	18.8	5.7	0.001	0.06	1.41	2.9	1.5	0.3	60.7	<0.01	0.03	1.5
ZZ95027		0.71	63.6	1490	389	14.1	0.004	0.08	14.40	3.3	5.2	0.6	62.9	<0.01	0.09	0.8
ZZ95028		0.34	97.0	700	28.2	9.4	0.143	0.47	7.89	3.2	12.9	0.6	166.0	<0.01	0.44	2.4
ZZ95029		0.78	45.5	1060	29.8	9.4	0.002	0.06	2.62	1.5	2.4	0.6	55.5	<0.01	0.09	0.5
ZZ95030		0.98	47.2	1260	41.4	13.3	0.009	0.10	3.48	2.3	6.0	0.5	46.1	<0.01	0.10	0.7
ZZ95031		0.57	258	2440	21.5	24.3	0.012	0.10	4.03	2.7	5.2	0.5	92.2	<0.01	0.08	0.5
ZZ95032		0.55	198.5	2370	38.6	18.9	0.005	0.06	3.26	1.8	6.9	0.6	88.5	<0.01	0.09	0.4
ZZ95033		0.53	118.0	1820	53.2	12.9	0.007	0.09	2.39	1.9	5.8	0.5	96.7	<0.01	0.08	0.7
ZZ95034		0.63	121.0	1650	43.1	14.1	0.003	0.07	2.59	2.5	5.6	0.5	67.4	<0.01	0.08	1.1
ZZ95035		0.61	131.0	1780	42.6	14.6	0.004	0.06	2.63	2.7	4.4	0.5	83.8	<0.01	0.07	1.5
ZZ95036		0.64	91.1	1840	48.7	14.8	0.003	0.06	4.38	3.2	4.8	0.5	79.9	0.01	0.10	2.1
ZZ95037		0.58	121.5	1570	40.5	13.1	0.004	0.08	4.15	4.6	4.8	0.4	84.6	0.01	0.10	1.7
ZZ95038		0.34	92.2	1690	37.0	12.1	0.003	0.07	4.56	4.0	4.4	0.4	86.6	<0.01	0.10	1.6
ZZ95039		0.64	250	2190	12.8	13.7	0.003	0.04	2.35	3.7	5.3	0.5	88.0	<0.01	0.10	1.1
ZZ95040		0.33	57.6	740	9.4	22.3	0.005	0.03	2.77	1.9	11.1	0.6	31.8	<0.01	0.06	0.3



ALS Canada Ltd.
 2103 Dollarton Hwy
 North Vancouver BC V7H 0A7
 Phone: 604 984 0221 Fax: 604 984 0218 www.alsglobal.com

To: ATAC RESOURCES LTD.
 C/O ARCHER, CATHRO & ASSOCIATES (1981)
 LIMITED
 1016-510 W HASTINGS ST
 VANCOUVER BC V6B 1L8

Page: 2 - D
 Total # Pages: 9 (A - D)
 Plus Appendix Pages
 Finalized Date: 28-SEP-2014
 Account: RCM

Project: Area G & H

CERTIFICATE OF ANALYSIS WH14146242

Sample Description	Method Analyte Units LOR	ME-MS41	ME-MS41	ME-MS41	ME-MS41	ME-MS41	ME-MS41	ME-MS41	ME-MS41
		Ti %	Ti ppm	U ppm	V ppm	W ppm	Y ppm	Zn ppm	Zr ppm
		0.005	0.02	0.05	1	0.05	0.05	2	0.5
ZZ95001		0.008	0.21	1.19	49	0.08	9.40	128	1.7
ZZ95002		0.025	0.11	0.85	59	0.24	12.25	120	1.3
ZZ95003		0.008	0.12	2.43	33	0.07	9.67	99	2.3
ZZ95004		0.013	0.13	1.71	50	0.14	12.45	124	2.3
ZZ95005		0.007	0.22	1.23	48	0.07	9.23	129	1.7
ZZ95006		0.018	0.15	1.05	64	0.20	6.97	84	1.3
ZZ95007		0.006	0.17	1.54	51	0.08	9.50	147	1.7
ZZ95008		0.007	0.25	1.38	62	0.09	10.40	160	1.4
ZZ95009		0.008	0.25	1.31	55	0.07	8.99	134	3.0
ZZ95010		0.008	0.25	1.28	63	0.14	11.10	147	1.3
ZZ95011		0.007	0.27	5.04	186	0.16	13.80	898	4.1
ZZ95012		0.008	0.27	3.31	245	0.16	14.00	806	2.8
ZZ95013		<0.005	0.32	3.54	134	0.11	14.00	812	2.0
ZZ95014		0.008	0.45	2.62	150	0.19	13.85	455	2.4
ZZ95015		0.007	0.53	3.22	142	0.22	14.40	334	2.3
ZZ95016		0.010	0.65	2.99	322	0.27	15.20	613	1.8
ZZ95017		0.009	0.54	4.27	303	0.20	19.20	405	2.0
ZZ95018		0.012	0.82	4.54	230	0.25	43.4	709	2.1
ZZ95019		0.012	0.69	3.82	183	0.20	20.7	613	1.9
ZZ95020		0.012	0.48	2.62	137	0.17	16.45	425	2.3
ZZ95021		0.011	0.11	4.58	36	0.08	9.20	120	2.8
ZZ95022		0.007	0.25	1.18	74	0.10	13.55	158	1.2
ZZ95023		0.017	0.20	1.17	61	0.12	13.10	148	1.6
ZZ95024		0.018	0.14	1.05	55	0.20	12.15	113	2.1
ZZ95025		0.008	0.21	1.24	45	0.07	9.19	136	1.0
ZZ95026		0.009	0.17	1.08	52	0.08	11.35	147	1.5
ZZ95027		0.017	0.84	3.61	96	0.29	8.63	755	<0.5
ZZ95028		0.007	8.60	6.95	278	0.72	8.74	577	4.7
ZZ95029		0.016	0.58	1.81	223	0.35	6.90	306	<0.5
ZZ95030		0.022	2.83	6.62	249	0.30	7.31	172	0.7
ZZ95031		0.017	3.47	11.40	813	0.31	14.80	1320	0.8
ZZ95032		0.016	2.81	7.37	748	0.24	11.85	1090	<0.5
ZZ95033		0.011	0.62	4.87	260	0.23	12.50	599	<0.5
ZZ95034		0.011	0.66	4.54	267	0.16	12.45	672	0.6
ZZ95035		0.011	0.72	3.71	294	0.23	11.35	767	<0.5
ZZ95036		0.010	0.57	2.96	442	0.24	11.10	599	0.8
ZZ95037		0.008	0.59	4.83	227	0.16	17.15	701	2.1
ZZ95038		0.007	0.60	3.77	187	0.20	15.15	585	1.7
ZZ95039		0.038	0.57	7.79	721	0.16	20.7	2560	0.6
ZZ95040		0.015	2.15	7.42	1500	0.17	24.9	499	<0.5



ALS Canada Ltd.
 2103 Dollarton Hwy
 North Vancouver BC V7H 0A7
 Phone: 604 984 0221 Fax: 604 984 0218 www.alsglobal.com

To: ATAC RESOURCES LTD.
 C/O ARCHER, CATHRO & ASSOCIATES (1981)
 LIMITED
 1016-510 W HASTINGS ST
 VANCOUVER BC V6B 1L8

Page: 3 - A
 Total # Pages: 9 (A - D)
 Plus Appendix Pages
 Finalized Date: 28-SEP-2014
 Account: RCM

Project: Area G & H

CERTIFICATE OF ANALYSIS WH14146242

Sample Description	Method	WEI-21	Au-ICP21	ME-MS41	ME-MS41	ME-MS41	ME-MS41	ME-MS41	ME-MS41	ME-MS41	ME-MS41	ME-MS41	ME-MS41	ME-MS41	ME-MS41	ME-MS41
	Analyte	Recvd Wt.	Au	Ag	Al	As	Au	B	Ba	Be	Bi	Ca	Cd	Ce	Co	Cr
Units		kg	ppm	ppm	%	ppm	ppm	ppm	ppm	ppm	ppm	%	ppm	ppm	ppm	ppm
LOR		0.02	0.001	0.01	0.01	0.1	0.2	10	10	0.05	0.01	0.01	0.01	0.02	0.1	1
ZZ95041		0.20	0.006	2.94	1.09	43.6	<0.2	10	1070	1.17	0.12	0.94	34.8	41.2	11.2	95
ZZ95042		0.21	0.007	1.45	1.08	30.9	<0.2	<10	900	0.84	0.15	0.48	10.20	19.00	6.0	150
ZZ95043		0.26	0.004	1.34	0.80	47.9	<0.2	<10	2640	0.61	0.14	1.02	12.00	28.1	12.5	39
ZZ95044		0.28	0.001	0.40	0.66	19.8	<0.2	<10	2090	0.43	0.11	8.97	2.34	14.60	7.4	23
ZZ95045		0.33	0.002	0.20	0.97	12.0	<0.2	<10	880	0.54	0.11	8.65	0.63	17.70	7.4	22
ZZ95046		0.32	0.001	0.16	0.61	8.7	<0.2	<10	1000	0.36	0.07	14.55	0.86	11.90	5.9	17
ZZ95047		0.26	<0.001	0.36	1.01	11.9	<0.2	<10	1460	0.56	0.13	3.63	0.94	17.20	7.5	24
ZZ95048		0.21	0.001	0.26	0.66	9.2	<0.2	<10	1330	0.34	0.09	6.22	1.16	11.15	5.5	17
ZZ95049		0.26	0.001	0.28	0.93	10.4	<0.2	<10	990	0.53	0.14	4.65	1.28	17.45	7.5	22
ZZ95050		0.23	0.001	0.12	1.26	11.1	<0.2	<10	700	0.46	0.20	1.02	0.72	25.6	6.7	21
ZZ95051		0.22	0.002	0.53	0.81	15.3	<0.2	<10	1190	0.70	0.15	6.06	2.26	18.50	6.8	20
ZZ95052		0.29	0.001	0.28	1.19	13.6	<0.2	<10	700	0.66	0.20	2.01	0.96	25.0	9.8	24
ZZ95053		0.19	0.001	0.16	1.46	8.5	<0.2	<10	490	0.72	0.22	1.45	0.43	31.2	9.3	27
ZZ95054		0.24	0.001	0.19	1.23	25.2	<0.2	<10	460	0.78	0.37	0.80	1.78	19.35	17.0	20
ZZ95055		0.29	0.002	0.26	1.21	21.0	<0.2	<10	500	0.77	0.35	0.64	1.30	19.60	13.7	22
ZZ95056		0.28	0.002	0.33	1.04	27.5	<0.2	<10	650	0.76	0.30	0.64	1.85	20.3	17.9	22
ZZ95057		0.29	0.002	0.33	1.04	25.1	<0.2	<10	850	0.77	0.31	0.94	2.11	20.8	16.5	23
ZZ95058		0.22	0.008	0.73	0.84	37.1	<0.2	<10	380	0.30	0.22	0.13	0.56	25.1	6.2	17
ZZ95059		0.28	0.004	1.26	0.71	152.5	<0.2	<10	740	0.52	0.20	0.48	2.37	25.4	21.3	23
ZZ95060		0.16	0.015	4.67	1.45	75.7	<0.2	<10	1670	0.72	0.25	1.28	1.65	33.8	15.6	19
ZZ95061		0.34	0.009	6.65	0.83	127.5	<0.2	<10	780	0.54	0.20	0.58	6.63	28.5	8.1	21
ZZ95062		0.21	0.003	0.99	1.90	24.7	<0.2	<10	630	0.62	0.25	0.19	1.24	29.7	10.2	29
ZZ95063		0.25	0.004	1.47	1.19	138.0	<0.2	<10	2910	0.83	0.22	0.90	6.81	24.3	18.6	41
ZZ95064		0.25	0.002	1.15	1.17	82.9	<0.2	<10	2330	0.74	0.22	0.83	6.27	27.9	15.8	41
ZZ95065		0.24	0.003	0.92	1.52	33.7	<0.2	<10	1760	0.90	0.16	0.58	3.48	30.7	14.0	67
ZZ95066		0.28	0.003	0.94	0.92	21.3	<0.2	<10	3550	0.59	0.15	2.21	4.38	18.45	8.5	31
ZZ95067		0.25	0.002	0.70	0.59	13.2	<0.2	<10	2420	0.37	0.10	2.21	5.90	14.70	5.7	25
ZZ95068		0.28	0.001	0.74	0.98	18.5	<0.2	<10	3550	0.61	0.15	3.01	4.70	16.50	9.4	30
ZZ95069		0.25	0.001	0.95	1.15	21.8	<0.2	<10	5210	0.71	0.16	2.85	3.32	18.85	10.0	33
ZZ95070		0.26	0.002	0.68	0.96	19.4	<0.2	<10	4190	0.57	0.16	3.42	4.92	18.40	10.2	29
ZZ95071		0.32	0.011	0.55	0.92	13.6	<0.2	<10	1600	0.54	0.13	4.06	1.72	20.2	7.5	29
ZZ95072		0.33	0.002	0.52	0.92	14.3	<0.2	<10	1860	0.51	0.12	6.43	1.75	18.30	8.0	28
ZZ95073		0.33	0.004	0.31	1.01	11.9	<0.2	<10	1180	0.52	0.12	6.78	1.29	18.10	7.8	27
ZZ95074		0.18	0.001	0.35	0.83	12.0	<0.2	<10	1350	0.46	0.12	3.22	1.39	16.60	6.7	24
ZZ95075		0.31	0.004	0.53	0.76	12.5	<0.2	<10	1680	0.45	0.15	5.76	3.82	16.45	6.1	20
ZZ95076		0.21	<0.001	0.03	1.65	8.7	<0.2	<10	370	0.59	0.21	1.05	0.89	25.9	6.4	25
ZZ95077		0.25	<0.001	0.07	1.65	14.8	<0.2	<10	380	1.00	0.20	2.51	0.69	25.0	9.2	25
ZZ95078		0.31	<0.001	0.21	1.42	19.1	<0.2	<10	850	0.87	0.20	1.59	2.30	41.4	12.5	28
ZZ95079		0.26	0.001	0.21	0.88	9.7	<0.2	<10	510	0.61	0.13	5.74	1.50	19.50	8.4	18
ZZ95080		0.30	0.001	0.17	1.13	48.0	<0.2	<10	90	0.75	0.20	0.43	0.67	18.25	24.5	131



ALS Canada Ltd.
 2103 Dollarton Hwy
 North Vancouver BC V7H 0A7
 Phone: 604 984 0221 Fax: 604 984 0218 www.alsglobal.com

To: ATAC RESOURCES LTD.
 C/O ARCHER, CATHRO & ASSOCIATES (1981)
 LIMITED
 1016-510 W HASTINGS ST
 VANCOUVER BC V6B 1L8

Page: 3 - B
 Total # Pages: 9 (A - D)
 Plus Appendix Pages
 Finalized Date: 28-SEP-2014
 Account: RCM

Project: Area G & H

CERTIFICATE OF ANALYSIS WH14146242

Sample Description	Method Analyte Units LOR	ME-MS41	ME-MS41	ME-MS41	ME-MS41	ME-MS41	ME-MS41	ME-MS41	ME-MS41	ME-MS41	ME-MS41	ME-MS41	ME-MS41	ME-MS41	ME-MS41	
		Cs	Cu	Fe	Ga	Ge	Hf	Hg	In	K	La	Li	Mg	Mn	Mo	Na
		ppm	ppm	%	ppm	ppm	ppm	ppm	ppm	%	ppm	ppm	%	ppm	ppm	%
ZZ95041		2.55	122.0	1.45	7.62	0.21	0.05	0.56	0.046	0.20	41.6	11.0	1.02	160	80.8	<0.01
ZZ95042		4.01	120.0	1.55	6.32	0.09	0.02	0.35	0.024	0.09	16.0	13.8	1.47	78	52.9	<0.01
ZZ95043		0.92	73.1	2.54	2.92	0.07	0.04	0.30	0.027	0.11	17.8	8.7	0.38	444	14.45	<0.01
ZZ95044		0.73	28.5	2.08	2.04	<0.05	0.08	0.14	0.018	0.09	8.7	7.5	3.28	335	4.54	<0.01
ZZ95045		0.65	18.0	2.08	2.61	<0.05	0.06	0.10	0.020	0.11	11.9	9.6	4.54	515	1.46	0.01
ZZ95046		0.59	17.4	1.51	1.73	<0.05	0.06	0.12	0.015	0.09	6.4	7.6	4.82	389	1.20	0.01
ZZ95047		0.50	28.0	2.13	2.85	<0.05	0.04	0.16	0.023	0.08	10.2	10.9	1.57	404	1.51	0.01
ZZ95048		0.47	22.2	1.55	1.90	<0.05	0.03	0.13	0.017	0.08	6.1	7.0	2.51	298	1.51	0.01
ZZ95049		0.58	23.6	2.18	2.67	<0.05	0.05	0.15	0.023	0.09	9.7	11.8	2.31	478	1.00	0.01
ZZ95050		0.76	10.0	2.23	4.44	<0.05	0.02	0.04	0.024	0.04	12.9	9.7	0.49	272	1.46	<0.01
ZZ95051		0.50	55.4	2.42	2.29	<0.05	0.03	0.26	0.026	0.04	12.4	8.2	2.69	477	3.06	0.01
ZZ95052		0.71	21.3	2.60	3.52	<0.05	0.03	0.15	0.028	0.05	13.6	11.6	0.76	592	1.32	0.01
ZZ95053		0.70	10.9	2.40	4.09	<0.05	0.04	0.08	0.032	0.05	15.9	15.5	0.85	243	0.51	0.01
ZZ95054		1.15	42.8	3.89	3.64	0.05	0.07	0.16	0.028	0.05	9.4	29.3	0.71	607	1.93	<0.01
ZZ95055		1.31	38.9	3.73	3.58	0.05	0.08	0.17	0.031	0.05	9.9	26.5	0.50	290	1.86	<0.01
ZZ95056		1.12	47.7	3.87	3.18	<0.05	0.06	0.20	0.030	0.05	10.3	21.7	0.48	656	2.32	<0.01
ZZ95057		1.13	44.3	3.64	3.29	0.06	0.07	0.21	0.028	0.06	10.6	22.8	0.65	425	2.59	<0.01
ZZ95058		1.28	28.8	3.20	4.10	0.05	<0.02	0.30	0.028	0.04	13.1	7.5	0.15	262	4.51	<0.01
ZZ95059		1.15	51.1	7.04	2.60	0.05	0.04	0.45	0.045	0.06	13.9	5.7	0.18	989	12.15	<0.01
ZZ95060		3.13	123.5	3.30	3.82	0.12	0.08	1.26	0.045	0.09	19.2	12.7	0.36	637	2.04	<0.01
ZZ95061		1.55	76.7	3.60	2.87	0.05	<0.02	3.54	0.039	0.07	15.8	4.8	0.14	191	7.20	<0.01
ZZ95062		1.23	16.6	3.22	5.76	<0.05	0.04	0.30	0.032	0.05	15.0	19.2	0.39	212	2.46	0.01
ZZ95063		0.95	45.7	3.26	3.40	0.05	0.06	0.75	0.032	0.13	13.5	10.2	0.39	1020	16.80	<0.01
ZZ95064		0.99	39.0	3.16	3.71	0.05	0.04	0.67	0.033	0.11	15.3	13.0	0.46	779	13.80	<0.01
ZZ95065		0.87	48.5	2.75	4.02	0.07	0.05	0.15	0.035	0.12	19.5	12.3	0.36	504	9.30	<0.01
ZZ95066		0.67	49.0	2.36	2.80	<0.05	0.04	0.17	0.026	0.10	11.3	8.6	0.84	404	5.58	<0.01
ZZ95067		0.54	27.9	1.32	2.03	0.05	0.03	0.14	0.017	0.07	10.3	5.8	0.82	431	4.78	<0.01
ZZ95068		0.58	49.2	2.46	2.91	<0.05	0.04	0.17	0.020	0.08	13.4	11.2	0.89	599	6.57	0.01
ZZ95069		0.71	35.0	2.68	3.21	0.05	0.04	0.16	0.024	0.09	14.1	11.1	0.79	393	6.88	<0.01
ZZ95070		0.71	37.0	2.43	2.94	<0.05	0.05	0.14	0.026	0.09	13.4	11.0	1.15	498	5.64	0.01
ZZ95071		0.70	25.9	2.09	2.71	<0.05	0.04	0.11	0.021	0.12	12.2	10.4	1.90	251	2.39	0.01
ZZ95072		0.85	27.0	2.12	2.68	<0.05	0.04	0.10	0.019	0.13	10.6	10.3	3.33	360	3.21	0.01
ZZ95073		0.71	25.2	2.04	2.79	<0.05	0.04	0.11	0.017	0.13	10.1	11.1	3.25	430	1.90	0.01
ZZ95074		0.57	23.0	1.74	2.38	<0.05	0.04	0.11	0.019	0.09	9.5	9.5	1.43	342	1.90	0.01
ZZ95075		0.72	33.8	1.87	2.23	<0.05	0.05	0.21	0.022	0.07	9.9	8.5	3.16	239	5.96	<0.01
ZZ95076		0.73	6.6	2.83	4.99	<0.05	0.02	0.02	0.029	0.02	13.4	10.4	0.63	341	1.57	0.01
ZZ95077		0.73	11.0	3.07	4.47	<0.05	0.05	0.05	0.036	0.04	14.0	10.9	1.17	495	1.46	0.01
ZZ95078		1.02	18.4	3.40	3.55	<0.05	0.04	0.09	0.043	0.08	12.5	18.2	1.12	884	3.39	<0.01
ZZ95079		0.65	31.5	2.14	2.42	<0.05	0.03	0.13	0.026	0.05	9.9	11.4	2.55	589	1.16	0.01
ZZ95080		5.24	63.8	6.12	4.09	<0.05	0.02	1.76	0.041	0.03	7.7	19.9	0.44	1180	17.55	0.01



ALS Canada Ltd.
 2103 Dollarton Hwy
 North Vancouver BC V7H 0A7
 Phone: 604 984 0221 Fax: 604 984 0218 www.alsglobal.com

To: ATAC RESOURCES LTD.
 C/O ARCHER, CATHRO & ASSOCIATES (1981)
 LIMITED
 1016-510 W HASTINGS ST
 VANCOUVER BC V6B 1L8

Page: 3 - C
 Total # Pages: 9 (A - D)
 Plus Appendix Pages
 Finalized Date: 28-SEP-2014
 Account: RCM

Project: Area G & H

CERTIFICATE OF ANALYSIS WH14146242

Sample Description	Method	ME-MS41	ME-MS41	ME-MS41	ME-MS41	ME-MS41	ME-MS41	ME-MS41	ME-MS41	ME-MS41	ME-MS41	ME-MS41	ME-MS41	ME-MS41	ME-MS41	
	Analyte	Nb	Ni	P	Pb	Rb	Re	S	Sb	Sc	Se	Sn	Sr	Ta	Te	Th
Units		ppm	ppm	ppm	ppm	ppm	ppm	%	ppm	ppm	ppm	ppm	ppm	ppm	ppm	ppm
LOR		0.05	0.2	10	0.2	0.1	0.001	0.01	0.05	0.1	0.2	0.2	0.2	0.01	0.01	0.2
ZZ95041		0.97	364	3960	10.9	25.1	0.007	0.03	13.55	6.0	16.2	0.7	164.5	<0.01	0.27	2.3
ZZ95042		1.06	313	2520	16.8	17.3	0.069	0.05	8.54	3.3	13.0	0.6	81.1	<0.01	0.29	1.0
ZZ95043		0.44	130.5	2640	28.8	11.1	0.013	0.07	5.35	3.6	7.9	0.4	129.5	<0.01	0.10	2.3
ZZ95044		0.39	53.5	1040	18.2	5.2	0.001	0.04	2.13	2.8	1.8	0.2	131.5	<0.01	0.05	2.3
ZZ95045		0.33	39.0	710	15.7	7.3	<0.001	0.01	0.93	3.3	0.9	0.3	73.9	<0.01	0.04	2.0
ZZ95046		0.19	35.5	580	12.0	5.4	<0.001	0.01	0.78	2.5	0.5	0.2	172.0	<0.01	0.03	1.7
ZZ95047		0.41	42.1	950	17.0	5.7	<0.001	0.05	1.15	2.1	1.3	0.3	46.0	<0.01	0.04	0.7
ZZ95048		0.30	32.3	850	11.7	4.9	<0.001	0.07	1.27	1.5	1.2	0.2	73.1	<0.01	0.03	0.5
ZZ95049		0.41	37.6	870	19.2	6.8	0.002	0.07	1.02	2.9	1.4	0.3	51.0	<0.01	0.04	1.6
ZZ95050		0.88	20.3	320	18.0	6.7	<0.001	0.01	0.63	2.5	0.7	0.5	18.6	<0.01	0.04	1.9
ZZ95051		0.44	41.6	940	35.0	4.7	<0.001	0.06	1.74	2.3	2.2	0.3	66.0	<0.01	0.05	0.5
ZZ95052		0.72	28.2	770	19.0	6.8	<0.001	0.04	0.95	2.9	1.4	0.4	32.7	<0.01	0.04	1.1
ZZ95053		0.88	27.5	460	18.3	5.6	<0.001	0.02	0.50	3.8	0.9	0.5	25.8	<0.01	0.03	1.7
ZZ95054		0.28	45.5	630	39.6	3.8	0.001	0.02	1.09	3.7	0.8	0.2	35.0	<0.01	0.04	4.3
ZZ95055		0.45	40.5	730	39.6	4.9	0.006	0.03	1.14	3.9	1.9	0.2	41.1	<0.01	0.05	4.0
ZZ95056		0.53	50.8	830	44.5	4.0	0.003	0.03	1.63	4.1	1.8	0.2	42.7	<0.01	0.04	3.7
ZZ95057		0.61	54.1	840	40.9	4.8	0.002	0.04	1.57	4.1	2.2	0.2	51.4	0.01	0.06	4.2
ZZ95058		0.72	16.0	1120	63.9	7.3	0.001	0.02	3.13	2.2	3.8	0.5	22.8	<0.01	0.07	1.8
ZZ95059		0.51	65.7	2450	77.3	7.0	0.001	0.09	6.45	4.7	5.1	0.4	190.5	<0.01	0.10	4.1
ZZ95060		0.82	62.6	1320	295	14.1	0.001	0.07	2.42	8.5	4.9	0.4	104.5	0.02	0.05	2.0
ZZ95061		0.48	53.8	1840	2200	8.8	<0.001	0.04	21.5	4.2	4.6	0.5	91.9	<0.01	0.07	1.5
ZZ95062		1.51	40.0	540	70.1	9.5	0.001	0.01	1.61	3.1	2.2	0.6	18.0	<0.01	0.05	4.1
ZZ95063		0.42	149.0	1620	99.6	9.5	0.008	0.08	7.18	4.1	6.7	0.5	91.5	<0.01	0.10	2.9
ZZ95064		0.64	98.4	1560	109.5	9.4	0.010	0.07	5.16	4.5	7.8	0.5	85.3	<0.01	0.11	3.5
ZZ95065		0.79	110.5	3310	22.3	12.8	<0.001	0.05	5.04	3.3	4.4	0.5	123.0	<0.01	0.12	3.2
ZZ95066		0.35	75.2	1280	15.4	6.7	0.002	0.11	3.52	2.6	2.3	0.4	78.9	<0.01	0.08	1.1
ZZ95067		0.49	43.1	1290	10.8	5.6	0.011	0.09	2.69	2.0	3.7	0.3	92.5	<0.01	0.06	1.1
ZZ95068		0.71	73.3	1040	20.9	6.1	0.003	0.10	3.03	2.2	2.9	0.3	87.9	<0.01	0.06	0.7
ZZ95069		0.53	81.4	770	21.5	6.8	0.001	0.09	3.06	3.1	2.2	0.4	77.3	<0.01	0.08	1.8
ZZ95070		0.73	70.4	1100	22.1	7.0	0.001	0.10	2.82	3.0	1.8	0.3	97.9	<0.01	0.06	1.8
ZZ95071		0.34	49.1	1060	15.4	7.3	0.002	0.06	1.87	2.8	1.7	0.3	55.5	<0.01	0.06	1.6
ZZ95072		0.32	53.3	1090	15.6	8.1	0.001	0.05	1.72	3.0	1.2	0.3	77.6	<0.01	0.04	2.0
ZZ95073		0.36	46.5	940	14.4	8.1	0.001	0.04	1.25	2.9	1.3	0.3	75.4	<0.01	0.03	1.4
ZZ95074		0.35	42.5	1010	14.3	6.5	0.002	0.07	1.41	2.3	1.7	0.3	44.6	<0.01	0.03	1.1
ZZ95075		0.32	86.2	850	16.1	6.0	0.002	0.06	3.12	2.5	2.2	0.4	54.0	<0.01	0.07	1.1
ZZ95076		0.88	15.4	210	21.6	4.5	<0.001	0.02	0.64	3.1	0.5	0.6	18.4	<0.01	0.03	2.1
ZZ95077		0.60	19.0	390	22.3	4.9	<0.001	0.04	0.86	5.1	0.9	0.5	28.7	<0.01	0.03	1.8
ZZ95078		0.34	52.9	840	29.7	10.4	0.001	0.04	1.41	5.7	1.3	0.4	18.7	<0.01	0.05	1.9
ZZ95079		0.34	29.1	930	15.8	6.4	0.001	0.08	0.89	2.4	1.6	0.2	60.6	<0.01	0.04	0.5
ZZ95080		0.32	72.5	1060	27.2	5.4	<0.001	0.05	3.60	5.4	1.8	0.2	20.3	<0.01	0.07	2.0



ALS Canada Ltd.
 2103 Dollarton Hwy
 North Vancouver BC V7H 0A7
 Phone: 604 984 0221 Fax: 604 984 0218 www.alsglobal.com

To: ATAC RESOURCES LTD.
 C/O ARCHER, CATHRO & ASSOCIATES (1981)
 LIMITED
 1016-510 W HASTINGS ST
 VANCOUVER BC V6B 1L8

Page: 3 - D
 Total # Pages: 9 (A - D)
 Plus Appendix Pages
 Finalized Date: 28-SEP-2014
 Account: RCM

Project: Area G & H

CERTIFICATE OF ANALYSIS WH14146242

Sample Description	Method Analyte Units LOR	ME-MS41	ME-MS41	ME-MS41	ME-MS41	ME-MS41	ME-MS41	ME-MS41	ME-MS41
		Ti %	Ti ppm	U ppm	V ppm	W ppm	Y ppm	Zn ppm	Zr ppm
		0.005	0.02	0.05	1	0.05	0.05	2	0.5
ZZ95041		0.060	3.21	12.90	2650	0.57	81.8	3600	3.5
ZZ95042		0.047	2.02	14.85	1020	0.44	30.4	2530	1.1
ZZ95043		0.011	0.75	5.49	278	0.21	20.9	1020	1.9
ZZ95044		0.009	0.23	1.29	77	0.08	9.66	210	3.2
ZZ95045		0.007	0.16	1.10	40	0.07	13.40	87	2.1
ZZ95046		0.006	0.14	1.13	26	<0.05	7.70	79	3.3
ZZ95047		0.009	0.15	1.17	53	0.15	11.55	123	1.4
ZZ95048		0.008	0.15	1.56	34	0.07	7.46	144	1.3
ZZ95049		0.008	0.13	1.33	44	0.08	10.35	160	1.7
ZZ95050		0.018	0.14	0.92	48	0.22	6.75	105	0.8
ZZ95051		0.011	0.19	1.82	41	0.12	18.15	204	1.0
ZZ95052		0.021	0.11	1.20	42	0.22	12.25	118	1.0
ZZ95053		0.020	0.11	1.06	47	0.19	12.05	101	1.0
ZZ95054		<0.005	0.09	1.25	38	<0.05	8.02	212	3.3
ZZ95055		0.005	0.08	1.68	37	0.07	8.17	227	3.4
ZZ95056		0.007	0.09	1.80	41	0.06	8.73	237	2.7
ZZ95057		0.007	0.11	1.68	54	0.06	9.03	275	3.4
ZZ95058		0.020	0.24	1.54	47	0.18	5.76	100	<0.5
ZZ95059		0.012	0.39	3.30	48	0.08	7.11	470	1.7
ZZ95060		0.006	0.32	5.71	45	0.12	45.8	231	2.5
ZZ95061		0.011	0.25	3.33	67	0.14	14.60	786	<0.5
ZZ95062		0.032	0.17	1.43	78	0.44	5.50	112	1.9
ZZ95063		0.006	0.44	2.85	204	0.20	12.35	1000	2.2
ZZ95064		0.009	0.36	3.81	185	0.19	13.20	866	2.1
ZZ95065		0.020	0.77	3.20	444	0.27	16.25	575	2.0
ZZ95066		0.008	0.42	2.13	109	0.17	13.20	349	1.5
ZZ95067		0.010	0.39	2.64	147	0.15	12.45	296	1.3
ZZ95068		0.009	0.28	1.71	116	0.15	15.70	426	1.4
ZZ95069		0.007	0.42	1.54	123	0.15	16.65	475	1.7
ZZ95070		0.011	0.39	1.33	98	0.18	14.20	419	2.0
ZZ95071		0.007	0.25	1.41	53	0.09	12.30	178	1.7
ZZ95072		0.007	0.31	1.20	50	0.09	12.00	166	2.0
ZZ95073		0.009	0.18	1.12	45	0.07	11.30	130	1.6
ZZ95074		0.008	0.21	1.72	46	0.09	10.50	135	1.7
ZZ95075		0.007	0.73	1.45	46	0.15	10.95	524	2.3
ZZ95076		0.015	0.15	0.58	75	0.19	6.55	140	0.9
ZZ95077		0.006	0.13	0.80	53	0.14	14.60	80	1.5
ZZ95078		0.007	0.17	1.46	46	0.10	13.60	347	1.4
ZZ95079		0.009	0.11	1.79	29	0.06	13.85	158	1.0
ZZ95080		0.007	0.27	1.27	75	0.06	8.64	166	1.0



ALS Canada Ltd.
 2103 Dollarton Hwy
 North Vancouver BC V7H 0A7
 Phone: 604 984 0221 Fax: 604 984 0218 www.alsglobal.com

To: ATAC RESOURCES LTD.
 C/O ARCHER, CATHRO & ASSOCIATES (1981)
 LIMITED
 1016-510 W HASTINGS ST
 VANCOUVER BC V6B 1L8

Page: 4 - A
 Total # Pages: 9 (A - D)
 Plus Appendix Pages
 Finalized Date: 28-SEP-2014
 Account: RCM

Project: Area G & H

CERTIFICATE OF ANALYSIS WH14146242

Sample Description	Method Analyte Units LOR	WEI-21 Recvd Wt. kg	Au-ICP21 Au ppm	ME-MS41 Ag ppm	ME-MS41 Al %	ME-MS41 As ppm	ME-MS41 Au ppm	ME-MS41 B ppm	ME-MS41 Ba ppm	ME-MS41 Be ppm	ME-MS41 Bi ppm	ME-MS41 Ca %	ME-MS41 Cd ppm	ME-MS41 Ce ppm	ME-MS41 Co ppm	ME-MS41 Cr ppm
		0.02	0.001	0.01	0.01	0.1	0.2	10	10	0.05	0.01	0.01	0.01	0.02	0.1	1
ZZ95081		0.24	0.001	0.55	0.97	17.6	<0.2	<10	160	0.93	0.31	0.85	0.48	15.75	12.0	20
ZZ95082		0.28	0.001	0.39	1.30	15.3	<0.2	<10	130	0.77	0.41	0.86	0.67	13.45	16.6	20
ZZ95083		0.19	0.001	0.33	1.62	31.5	<0.2	<10	440	0.87	0.23	1.17	1.40	26.4	17.6	49
ZZ95084		0.26	0.003	0.03	0.66	6.0	<0.2	<10	230	0.14	0.25	0.08	0.29	30.4	3.5	14
ZZ95085		0.27	0.002	0.37	2.76	73.8	<0.2	<10	300	1.89	0.14	2.45	0.76	84.7	37.4	180
ZZ95086		0.18	0.003	0.42	1.16	41.6	<0.2	<10	460	1.01	0.26	1.46	1.63	26.1	16.6	52
ZZ95087		0.22	0.003	0.42	1.20	33.0	<0.2	<10	430	0.98	0.28	1.22	1.68	27.2	16.4	52
ZZ95088		0.21	0.002	1.70	0.89	32.3	<0.2	10	5690	0.73	0.17	1.98	7.23	23.8	7.4	34
ZZ95089		0.32	0.005	1.81	0.86	34.9	<0.2	<10	3220	0.68	0.19	1.61	3.83	21.2	8.4	37
ZZ95090		0.23	0.005	1.55	0.72	72.3	<0.2	<10	1680	0.76	0.17	1.25	3.63	26.3	6.0	42
ZZ95091		0.24	0.009	0.49	1.73	11.6	<0.2	<10	340	0.51	0.14	1.80	1.23	27.5	5.4	29
ZZ95092		0.25	<0.001	0.70	0.61	57.7	<0.2	<10	1340	0.39	0.14	3.07	1.44	16.95	7.5	21
ZZ95093		0.23	<0.001	0.66	0.40	64.5	<0.2	<10	1270	0.37	0.14	3.12	1.54	15.05	7.7	21
ZZ95094		0.24	<0.001	0.34	1.12	10.4	<0.2	<10	570	0.62	0.14	1.43	1.05	21.9	5.9	25
ZZ95095		0.25	0.001	0.40	1.12	16.5	<0.2	<10	830	0.73	0.16	4.66	1.16	16.80	9.2	26
ZZ95096		0.24	0.001	0.31	1.08	16.3	<0.2	<10	680	0.74	0.18	3.72	1.20	17.70	11.3	23
ZZ95097		0.22	0.002	0.21	0.96	15.0	<0.2	<10	550	0.63	0.14	3.44	1.02	19.25	8.6	22
ZZ95098		0.50	0.001	0.20	0.93	14.0	<0.2	<10	400	0.57	0.13	5.29	0.89	19.50	8.3	24
ZZ95099		0.28	0.001	0.21	1.08	12.3	<0.2	<10	450	0.55	0.16	3.58	0.60	21.1	9.7	23
ZZ95100		0.32	0.001	0.36	1.05	13.7	<0.2	<10	470	0.55	0.20	2.43	10.05	29.6	10.8	25
ZZ95101		0.25	0.001	0.21	0.86	11.1	<0.2	<10	270	0.59	0.14	9.49	0.55	15.80	8.5	20
ZZ95102		0.28	0.001	0.27	1.11	11.3	<0.2	<10	1220	0.69	0.18	3.38	0.81	17.70	8.7	25
ZZ95103		0.27	0.001	0.20	0.70	10.4	<0.2	<10	540	0.47	0.10	6.64	1.62	15.00	7.7	19
ZZ95104		0.31	<0.001	0.11	2.50	18.6	<0.2	<10	380	1.10	0.29	1.31	0.42	43.4	12.6	37
ZZ95105		0.27	0.001	0.15	1.62	10.5	<0.2	<10	260	0.60	0.23	1.05	0.20	29.1	6.5	27
ZZ95106		0.31	0.001	0.32	1.21	11.7	<0.2	<10	310	0.71	0.20	3.41	0.61	23.9	10.0	24
ZZ95107		0.21	<0.001	0.07	0.77	8.1	<0.2	<10	110	0.44	0.09	11.85	0.54	15.05	5.2	13
ZZ95108		0.22	0.001	0.04	1.52	10.7	<0.2	<10	170	0.74	0.23	1.55	0.79	23.1	6.6	23
ZZ95109		0.18	<0.001	0.06	1.45	6.4	<0.2	<10	80	0.49	0.15	6.32	1.13	16.95	4.2	18
ZZ95110		0.22	<0.001	0.17	1.20	15.0	<0.2	<10	170	0.82	0.21	3.37	0.95	18.40	9.4	19
ZZ95111		0.20	<0.001	0.09	1.74	9.8	<0.2	<10	170	0.84	0.21	3.63	0.61	29.6	6.1	26
ZZ95112		0.26	0.001	0.30	1.25	15.7	<0.2	<10	230	0.88	0.22	1.44	0.82	20.8	11.2	20
ZZ95113		0.27	0.001	0.06	1.97	14.7	<0.2	<10	240	0.95	0.27	1.52	0.22	45.7	10.3	35
ZZ95114		0.19	<0.001	0.15	1.16	9.4	<0.2	<10	90	0.52	0.14	11.50	0.60	15.70	5.4	16
ZZ95115		0.23	<0.001	0.03	1.93	9.9	<0.2	<10	160	0.95	0.25	1.63	0.60	28.3	8.6	30
ZZ95116		0.22	<0.001	0.17	1.62	13.6	<0.2	<10	270	1.13	0.23	2.66	1.06	23.4	8.1	22
ZZ95117		0.24	<0.001	0.09	0.78	12.6	<0.2	<10	100	0.54	0.12	10.45	0.48	16.00	4.3	15
ZZ95118		0.21	0.003	0.11	1.64	13.8	<0.2	<10	210	0.87	0.23	3.47	1.18	24.3	8.9	24
ZZ95119		0.18	0.002	0.16	1.41	13.5	<0.2	<10	180	0.86	0.20	5.09	0.91	23.7	9.4	22
ZZ95120		0.17	<0.001	0.20	1.02	13.9	<0.2	10	160	0.87	0.15	8.13	1.42	25.7	5.7	17



ALS Canada Ltd.
 2103 Dollarton Hwy
 North Vancouver BC V7H 0A7
 Phone: 604 984 0221 Fax: 604 984 0218 www.alsglobal.com

To: ATAC RESOURCES LTD.
 C/O ARCHER, CATHRO & ASSOCIATES (1981)
 LIMITED
 1016-510 W HASTINGS ST
 VANCOUVER BC V6B 1L8

Page: 4 - D
 Total # Pages: 9 (A - D)
 Plus Appendix Pages
 Finalized Date: 28-SEP-2014
 Account: RCM

Project: Area G & H

CERTIFICATE OF ANALYSIS WH14146242

Sample Description	Method Analyte Units LOR	ME-MS41	ME-MS41	ME-MS41	ME-MS41	ME-MS41	ME-MS41	ME-MS41	ME-MS41
		Ti %	Ti ppm	U ppm	V ppm	W ppm	Y ppm	Zn ppm	Zr ppm
		0.005	0.02	0.05	1	0.05	0.05	2	0.5
ZZ95081		0.009	0.11	2.16	34	0.10	11.05	128	1.3
ZZ95082		<0.005	0.11	1.91	24	<0.05	8.37	152	1.8
ZZ95083		0.013	0.17	2.68	71	0.11	8.63	158	1.7
ZZ95084		0.022	0.09	0.45	42	0.14	2.10	36	<0.5
ZZ95085		0.024	0.15	1.15	149	<0.05	15.85	183	1.2
ZZ95086		0.010	0.15	2.86	53	0.06	11.00	176	2.0
ZZ95087		0.009	0.14	3.34	54	0.05	10.55	186	2.2
ZZ95088		0.009	1.01	5.33	181	0.21	20.2	516	2.7
ZZ95089		0.009	0.80	6.10	133	0.19	17.55	466	2.3
ZZ95090		0.009	0.73	6.55	302	0.41	16.10	407	2.3
ZZ95091		0.023	0.11	1.14	59	0.20	18.10	57	0.8
ZZ95092		0.008	0.53	1.79	25	0.12	20.2	349	1.0
ZZ95093		0.006	0.62	2.06	19	0.11	18.05	378	1.0
ZZ95094		0.007	0.16	1.27	62	0.10	20.3	114	1.4
ZZ95095		<0.005	0.21	1.19	59	0.06	16.20	139	2.2
ZZ95096		0.006	0.15	1.01	41	0.07	14.20	131	2.0
ZZ95097		0.009	0.12	2.05	38	0.07	11.00	100	1.3
ZZ95098		0.010	0.14	1.20	40	0.08	11.45	94	1.3
ZZ95099		0.010	0.14	0.87	40	0.08	10.95	102	1.3
ZZ95100		0.023	0.30	1.06	49	0.16	13.70	291	2.2
ZZ95101		0.005	0.14	1.09	32	0.05	12.05	86	2.0
ZZ95102		0.008	0.11	1.41	38	0.07	11.45	103	1.3
ZZ95103		0.006	0.09	1.24	29	0.05	10.55	127	1.6
ZZ95104		0.019	0.17	1.13	65	0.26	15.90	132	1.7
ZZ95105		0.020	0.14	0.93	51	0.20	7.29	68	0.8
ZZ95106		0.018	0.10	0.82	41	0.13	12.45	125	1.0
ZZ95107		0.009	0.11	1.84	31	0.07	8.88	82	1.3
ZZ95108		0.018	0.15	0.82	61	0.12	5.08	236	1.5
ZZ95109		0.017	0.09	1.88	58	0.12	4.19	147	0.7
ZZ95110		0.010	0.14	1.27	36	0.17	7.06	301	1.7
ZZ95111		0.015	0.12	1.02	50	0.15	7.63	155	1.2
ZZ95112		0.011	0.14	2.42	35	0.13	9.16	232	1.5
ZZ95113		0.032	0.16	1.04	62	0.27	9.11	60	4.5
ZZ95114		0.013	0.09	1.29	30	0.10	4.55	101	0.8
ZZ95115		0.022	0.11	0.89	59	0.18	6.42	124	1.4
ZZ95116		0.008	0.15	1.28	45	0.12	10.40	267	2.2
ZZ95117		0.008	0.15	1.36	25	0.07	5.73	79	1.4
ZZ95118		0.018	0.14	0.95	49	0.13	8.24	243	2.0
ZZ95119		0.017	0.13	0.93	41	0.15	9.74	166	1.4
ZZ95120		0.006	0.14	1.66	26	0.06	10.00	163	1.6



ALS Canada Ltd.
 2103 Dollarton Hwy
 North Vancouver BC V7H 0A7
 Phone: 604 984 0221 Fax: 604 984 0218 www.alsglobal.com

To: ATAC RESOURCES LTD.
 C/O ARCHER, CATHRO & ASSOCIATES (1981)
 LIMITED
 1016-510 W HASTINGS ST
 VANCOUVER BC V6B 1L8

Page: 5 - D
 Total # Pages: 9 (A - D)
 Plus Appendix Pages
 Finalized Date: 28-SEP-2014
 Account: RCM

Project: Area G & H

CERTIFICATE OF ANALYSIS WH14146242

Sample Description	Method Analyte Units LOR	ME-MS41	ME-MS41	ME-MS41	ME-MS41	ME-MS41	ME-MS41	ME-MS41	ME-MS41
		Ti %	Ti ppm	U ppm	V ppm	W ppm	Y ppm	Zn ppm	Zr ppm
		0.005	0.02	0.05	1	0.05	0.05	2	0.5
ZZ95121		0.014	0.12	0.74	39	0.13	8.23	92	1.5
ZZ95122		0.007	0.11	0.74	32	0.10	16.85	97	2.8
ZZ95123		0.011	0.12	0.92	31	0.10	11.10	145	1.9
ZZ95124		0.018	0.13	1.05	48	0.15	11.15	104	1.6
ZZ95125		0.037	0.12	0.68	48	0.22	12.10	87	1.7
ZZ95126		0.009	0.15	0.79	36	0.10	13.60	108	2.5
ZZ95127		0.006	0.11	0.95	24	0.06	11.90	74	2.0
ZZ95128		0.005	0.10	0.83	17	<0.05	7.55	73	1.7
ZZ95129		0.018	0.12	1.18	46	0.20	10.45	119	1.8
ZZ95130		0.020	0.12	0.77	49	0.17	11.30	102	2.4
ZZ95131		0.021	0.15	1.20	60	0.15	7.47	126	3.2
ZZ95132		0.018	0.12	0.87	41	0.13	13.00	98	2.2
ZZ95133		0.016	0.13	0.84	52	0.12	10.95	167	1.5
ZZ95134		0.021	0.12	0.69	48	0.14	13.90	89	2.1
ZZ95135		0.015	0.12	0.79	51	0.15	17.50	105	2.4
ZZ95136		0.005	0.09	0.82	17	<0.05	7.43	66	1.5
ZZ95137		0.006	0.11	1.14	27	0.07	12.00	78	2.1
ZZ95138		0.014	0.13	0.74	50	0.14	7.45	85	3.0
ZZ95139		0.017	0.12	0.63	45	0.15	12.65	124	2.3
ZZ95140		0.012	0.08	1.07	23	0.11	8.65	75	1.2
ZZ95141		0.014	0.13	1.03	41	0.11	10.90	164	1.8
ZZ95142		0.007	0.13	0.95	34	0.07	11.60	106	2.1
ZZ95143		0.015	0.13	1.36	45	0.11	11.90	106	1.4
ZZ95144		0.009	0.10	1.22	31	0.10	12.45	81	1.3
ZZ95145		0.009	0.10	1.10	30	0.08	11.90	85	1.6
ZZ95146		0.005	0.10	0.96	19	<0.05	8.26	77	1.9
ZZ95147		0.008	0.10	0.99	30	0.12	10.65	83	2.0
ZZ95148		0.005	0.09	0.95	16	0.05	7.31	66	1.5
ZZ95149		0.016	0.11	1.69	48	0.18	10.60	98	1.9
ZZ95150		0.026	0.12	0.86	63	0.18	6.36	140	1.4
ZZ95151		0.005	0.09	0.89	19	0.05	9.22	66	1.9
ZZ95152		0.020	0.12	0.98	49	0.16	13.05	112	1.9
ZZ95153		0.006	0.10	0.90	23	0.06	9.33	76	2.0
ZZ95154		0.005	0.12	0.97	26	0.07	12.05	87	2.7
ZZ95155		<0.005	0.09	0.94	16	0.05	5.99	73	1.7
ZZ95156		<0.005	0.09	0.98	16	<0.05	5.81	75	1.4
ZZ95157		0.030	0.12	1.70	54	0.27	7.86	97	0.9
ZZ95158		0.006	0.12	0.59	15	0.07	7.53	129	1.3
ZZ95159		0.011	0.17	0.85	35	0.13	5.22	215	1.8
ZZ95160		0.005	0.19	1.13	25	0.08	8.94	119	2.0



ALS Canada Ltd.
 2103 Dollarton Hwy
 North Vancouver BC V7H 0A7
 Phone: 604 984 0221 Fax: 604 984 0218 www.alsglobal.com

To: ATAC RESOURCES LTD.
 C/O ARCHER, CATHRO & ASSOCIATES (1981)
 LIMITED
 1016-510 W HASTINGS ST
 VANCOUVER BC V6B 1L8

Page: 6 - D
 Total # Pages: 9 (A - D)
 Plus Appendix Pages
 Finalized Date: 28-SEP-2014
 Account: RCM

Project: Area G & H

CERTIFICATE OF ANALYSIS WH14146242

Sample Description	Method	ME-MS41	ME-MS41	ME-MS41	ME-MS41	ME-MS41	ME-MS41	ME-MS41	ME-MS41
	Analyte	Ti	Ti	U	V	W	Y	Zn	Zr
Units		%	ppm	ppm	ppm	ppm	ppm	ppm	ppm
LOR		0.005	0.02	0.05	1	0.05	0.05	2	0.5
ZZ95161		0.022	0.20	0.78	43	0.22	11.25	131	2.0
ZZ95162		0.011	0.16	1.04	41	0.12	14.40	133	2.2
ZZ95163		0.008	0.18	1.41	27	0.10	12.20	85	1.3
ZZ95164		0.016	0.14	2.02	43	0.18	9.17	140	0.9
ZZ95165		0.013	0.13	2.42	28	0.08	13.80	104	0.9
ZZ95166		0.019	0.16	2.04	53	0.17	11.75	157	1.2
ZZ95167		0.007	0.22	1.92	41	0.05	14.35	106	1.9
ZZ95168		0.008	0.26	1.66	49	0.08	16.30	137	2.0
ZZ95169		0.009	0.23	1.78	42	0.07	14.85	124	1.4
ZZ95170		0.007	0.29	1.72	37	0.06	12.30	109	1.5
ZZ95171		0.008	0.25	1.70	39	0.07	12.65	132	1.2
ZZ95172		0.022	0.17	0.98	64	0.23	14.30	95	1.4
ZZ95173		0.009	0.23	1.67	46	0.10	15.70	105	1.2
ZZ95174		0.007	0.33	1.99	43	0.08	13.55	137	2.2
ZZ95175		0.007	0.33	1.43	39	0.07	13.80	122	2.4
ZZ95176		0.012	0.26	1.13	57	0.15	12.35	101	1.4
ZZ95177		0.006	0.21	2.38	46	0.08	14.95	156	1.9
ZZ95178		0.007	0.25	2.39	49	0.11	20.3	165	1.6
ZZ95179		0.007	0.32	0.86	32	0.06	12.95	591	1.1
ZZ95180		0.008	0.32	1.45	44	0.12	13.70	124	1.6
ZZ95181		0.005	0.18	0.86	44	0.07	10.20	130	1.0
ZZ95182		<0.005	0.20	1.25	62	0.06	20.9	156	1.4
ZZ95183		0.006	0.38	1.70	124	0.09	17.15	349	2.5
ZZ95184		0.005	0.34	1.66	72	0.07	15.40	213	1.7
ZZ95185		<0.005	0.37	2.61	42	0.12	18.50	275	1.9
ZZ95186		0.006	0.43	2.12	53	0.10	14.65	197	2.6
ZZ95187		0.013	0.24	1.85	59	0.22	13.70	203	1.6
ZZ95188		0.012	0.25	1.82	56	0.17	19.20	138	1.7
ZZ95189		0.014	0.18	1.46	43	0.15	14.10	86	1.2
ZZ95190		0.016	0.31	0.99	58	0.17	19.25	119	1.8
ZZ95191		0.009	0.29	1.58	43	0.11	15.45	114	1.2
ZZ95192		0.015	0.28	1.55	48	0.19	13.45	112	1.6
ZZ95193		0.010	0.37	1.70	43	0.07	12.70	112	2.1
ZZ95194		0.005	0.33	1.43	71	0.08	28.2	223	2.1
ZZ95195		0.014	0.27	1.18	46	0.14	14.50	114	1.3
ZZ95196		0.012	0.23	2.03	36	0.23	12.00	122	0.9
ZZ95197		0.014	0.14	1.62	33	0.11	11.85	103	0.6
ZZ95198		0.018	0.22	2.06	56	0.05	14.25	221	2.7
ZZ95199		0.009	0.31	2.31	39	0.25	16.30	168	1.1
ZZ95200		0.012	0.27	2.23	58	0.06	15.40	254	2.6



ALS Canada Ltd.
 2103 Dollarton Hwy
 North Vancouver BC V7H 0A7
 Phone: 604 984 0221 Fax: 604 984 0218 www.alsglobal.com

To: ATAC RESOURCES LTD.
 C/O ARCHER, CATHRO & ASSOCIATES (1981)
 LIMITED
 1016-510 W HASTINGS ST
 VANCOUVER BC V6B 1L8

Page: 7 - D
 Total # Pages: 9 (A - D)
 Plus Appendix Pages
 Finalized Date: 28-SEP-2014
 Account: RCM

Project: Area G & H

CERTIFICATE OF ANALYSIS WH14146242

Sample Description	Method	ME-MS41	ME-MS41	ME-MS41	ME-MS41	ME-MS41	ME-MS41	ME-MS41	ME-MS41
	Analyte	Ti	Ti	U	V	W	Y	Zn	Zr
Units		%	ppm	ppm	ppm	ppm	ppm	ppm	ppm
LOR		0.005	0.02	0.05	1	0.05	0.05	2	0.5
ZZ95201		0.013	0.30	2.22	70	0.11	16.65	299	2.7
ZZ95202		0.014	0.29	2.40	72	0.11	17.55	304	2.5
ZZ95203		0.014	0.25	2.21	70	0.08	15.65	271	2.6
ZZ95204		0.013	0.29	2.64	78	0.12	16.75	291	2.7
ZZ95205		0.012	0.35	2.21	89	0.09	18.95	332	3.2
ZZ95206		0.006	0.22	2.03	41	0.06	11.15	114	1.8
ZZ95207		0.013	0.16	1.58	41	0.14	12.55	87	0.9
ZZ95208		0.014	0.13	1.94	40	0.12	12.25	75	0.8
ZZ95209		0.026	0.13	1.22	48	0.28	10.95	83	2.0
ZZ95210		0.017	0.21	1.31	44	0.19	11.20	96	2.0
ZZ95211		0.017	0.53	1.97	114	0.19	7.47	83	2.1
ZZ95212		0.005	0.12	1.53	30	0.10	8.98	88	1.2
ZZ95213		<0.005	0.12	0.99	34	0.09	10.05	98	1.4
ZZ95214		0.006	0.32	1.80	59	0.09	17.65	153	2.1
ZZ95215		0.009	0.33	1.32	49	0.09	15.40	149	2.2
ZZ95216		0.005	0.29	1.68	43	0.07	13.10	145	1.9
ZZ95217		0.008	0.26	1.56	49	0.16	15.90	150	1.7
ZZ95218		0.010	0.21	1.86	47	0.11	14.60	133	1.6
ZZ95219		0.007	0.22	3.21	66	0.18	16.40	128	1.4
ZZ95220		0.010	0.30	1.76	58	0.14	18.40	158	1.8
ZZ95221		0.013	0.36	5.10	127	0.18	18.45	243	2.0
ZZ95222		0.012	0.42	1.21	57	0.14	17.95	191	2.2
ZZ95223		0.009	0.24	1.50	40	0.08	10.55	98	1.9
ZZ95224		0.010	0.31	2.89	60	0.12	15.55	137	2.0
ZZ95225		0.011	0.19	1.45	50	0.13	11.65	116	1.3
ZZ95226		0.013	0.26	1.70	66	0.17	13.55	128	1.3
ZZ95227		0.008	0.26	1.24	38	0.11	10.80	120	1.7
ZZ95228		0.009	0.24	1.15	34	0.08	10.60	127	1.9
ZZ95229		0.008	0.20	1.06	37	0.07	10.80	119	2.6
ZZ95230		0.010	0.28	1.65	42	0.07	11.15	136	2.5
ZZ95231		0.013	0.29	2.53	85	0.16	16.60	272	2.1
ZZ95232		0.010	0.21	2.08	74	0.06	17.60	251	2.0
ZZ95233		0.012	0.30	2.99	74	0.11	15.85	300	2.9
ZZ95234		0.009	0.38	3.31	90	0.08	18.10	302	3.5
ZZ95235		0.010	0.33	3.74	90	0.09	19.90	305	4.0
ZZ95236		0.013	0.30	3.07	69	0.07	16.60	293	3.0
ZZ95237		0.013	0.16	1.72	40	<0.05	11.45	189	2.6
ZZ95238		0.014	0.22	2.05	56	0.05	13.55	226	2.6
ZZ95239		0.008	0.21	2.54	31	0.05	3.48	75	0.8
ZZ95240		0.008	1.19	2.66	51	0.07	12.95	159	1.3



ALS Canada Ltd.
 2103 Dollarton Hwy
 North Vancouver BC V7H 0A7
 Phone: 604 984 0221 Fax: 604 984 0218 www.alsglobal.com

To: ATAC RESOURCES LTD.
 C/O ARCHER, CATHRO & ASSOCIATES (1981)
 LIMITED
 1016-510 W HASTINGS ST
 VANCOUVER BC V6B 1L8

Page: 8 - D
 Total # Pages: 9 (A - D)
 Plus Appendix Pages
 Finalized Date: 28-SEP-2014
 Account: RCM

Project: Area G & H

CERTIFICATE OF ANALYSIS WH14146242

Sample Description	Method Analyte Units LOR	ME-MS41	ME-MS41	ME-MS41	ME-MS41	ME-MS41	ME-MS41	ME-MS41	ME-MS41
		Ti %	Ti ppm	U ppm	V ppm	W ppm	Y ppm	Zn ppm	Zr ppm
		0.005	0.02	0.05	1	0.05	0.05	2	0.5
ZZ95241		0.010	1.08	2.83	61	0.09	12.90	147	1.2
ZZ95242		0.011	0.30	2.04	19	0.05	3.89	65	1.2
ZZ95243		0.010	0.80	2.29	46	0.10	9.40	128	1.0
ZZ95244		0.009	1.04	3.18	22	0.06	3.85	90	0.9
ZZ95245		0.014	2.37	2.80	65	0.16	12.30	322	1.3
ZZ95246		0.016	0.58	1.99	46	0.11	7.17	149	0.7
ZZ95247		0.014	0.69	1.55	46	0.14	7.27	149	1.0
ZZ95248		0.015	0.72	1.23	35	0.12	5.49	128	0.9
ZZ95249		0.011	1.34	2.71	67	0.11	12.50	342	1.7
ZZ95250		0.008	1.05	3.63	64	0.09	13.20	255	2.2
ZZ95251		0.008	1.06	6.00	61	0.08	10.35	223	0.9
ZZ95252		0.010	0.46	5.07	46	0.09	8.06	265	0.8
ZZ95253		0.013	0.72	3.87	70	0.10	10.05	241	0.9
ZZ95254		0.013	0.63	2.00	58	0.12	11.10	189	1.2
ZZ95255		0.025	0.34	2.80	73	0.20	4.55	328	0.6
ZZ95256		0.026	0.43	2.05	70	0.16	11.35	159	0.6
ZZ95257		0.011	0.43	2.48	48	0.10	7.38	281	0.6
ZZ95258		0.020	0.48	3.50	63	0.14	7.84	234	1.0
ZZ95259		0.014	0.81	3.52	95	0.11	10.45	150	0.9
ZZ95260		0.007	0.91	2.47	96	0.11	22.5	308	2.2
ZZ95261		0.008	0.79	3.15	69	0.11	16.35	233	1.3
ZZ95262		0.006	0.57	3.25	53	0.06	17.35	169	1.2
ZZ95263		0.006	0.58	2.78	88	0.05	18.30	251	1.3
ZZ95264		0.006	0.78	10.05	181	0.20	21.8	406	2.5
ZZ95265		0.022	0.39	2.28	106	0.32	7.31	108	1.1
ZZ95266		0.011	0.45	2.56	93	0.11	15.65	151	2.1
ZZ95267		0.009	0.70	2.52	118	0.14	20.2	193	2.0
ZZ95268		0.010	0.68	3.14	93	0.15	15.25	221	1.3
ZZ95269		0.008	0.65	2.50	89	0.10	12.50	199	1.5
ZZ95270		0.008	0.63	2.17	89	0.11	20.8	206	2.0
ZZ95271		0.024	0.19	1.45	59	0.22	28.4	142	0.8
ZZ95272		0.010	0.60	2.66	78	0.09	19.05	194	1.7
ZZ95273		0.010	0.29	2.11	58	0.09	13.75	143	1.5
ZZ95274		0.011	0.22	1.63	54	0.14	15.50	108	2.4
ZZ95275		0.013	0.23	1.51	56	0.12	12.85	122	1.8
ZZ95276		0.017	0.27	1.39	72	0.18	6.52	127	0.5
ZZ95277		<0.005	0.64	4.09	114	0.14	25.8	151	2.9
ZZ95278		0.013	0.24	1.69	68	0.14	27.5	170	0.6
ZZ95279		<0.005	0.32	3.66	57	0.05	13.20	108	2.0
ZZ95280		0.005	0.32	3.13	58	0.06	21.7	135	1.8



ALS Canada Ltd.
 2103 Dollarton Hwy
 North Vancouver BC V7H 0A7
 Phone: 604 984 0221 Fax: 604 984 0218 www.alsglobal.com

To: ATAC RESOURCES LTD.
 C/O ARCHER, CATHRO & ASSOCIATES (1981)
 LIMITED
 1016-510 W HASTINGS ST
 VANCOUVER BC V6B 1L8

Page: 9 - A
 Total # Pages: 9 (A - D)
 Plus Appendix Pages
 Finalized Date: 28-SEP-2014
 Account: RCM

Project: Area G & H

CERTIFICATE OF ANALYSIS WH14146242

Sample Description	Method Analyte Units LOR	WEI-21 Recvd Wt. kg	Au-ICP21 Au ppm	ME-MS41 Ag ppm	ME-MS41 Al %	ME-MS41 As ppm	ME-MS41 Au ppm	ME-MS41 B ppm	ME-MS41 Ba ppm	ME-MS41 Be ppm	ME-MS41 Bi ppm	ME-MS41 Ca %	ME-MS41 Cd ppm	ME-MS41 Ce ppm	ME-MS41 Co ppm	ME-MS41 Cr ppm
		0.02	0.001	0.01	0.01	0.1	0.2	10	10	0.05	0.01	0.01	0.01	0.02	0.1	1
ZZ95281		0.29	0.014	1.30	0.92	31.3	<0.2	10	660	0.73	0.16	3.04	2.61	16.50	6.4	31
ZZ95282		0.31	0.009	0.83	1.00	17.8	<0.2	10	770	0.68	0.16	4.94	1.63	14.70	7.2	24
ZZ95283		0.37	0.005	0.99	0.48	21.6	<0.2	10	870	0.47	0.12	8.13	1.41	8.70	4.1	17
ZZ95284		0.30	0.004	0.43	1.16	10.8	<0.2	<10	640	0.68	0.20	4.03	1.33	18.85	9.8	23
ZZ95285		0.34	0.004	0.80	0.99	17.6	<0.2	<10	760	0.63	0.16	5.14	1.15	17.10	7.7	23
ZZ95286		0.24	0.004	0.19	1.25	25.0	<0.2	<10	410	0.43	0.27	0.64	4.78	24.9	8.9	24
ZZ95287		0.22	0.005	0.28	0.76	10.3	<0.2	<10	610	0.40	0.13	3.61	2.24	10.40	4.4	15
ZZ95288		0.47	0.009	1.09	0.78	20.6	<0.2	10	610	0.60	0.13	5.44	1.07	13.35	5.8	25
ZZ95289		0.24	0.010	0.92	0.80	14.7	<0.2	10	700	0.55	0.13	5.01	1.17	12.85	5.3	24
ZZ95290		0.37	0.004	0.92	0.67	17.7	<0.2	10	590	0.47	0.12	8.33	1.43	13.60	5.5	22

***** See Appendix Page for comments regarding this certificate *****



ALS Canada Ltd.
 2103 Dollarton Hwy
 North Vancouver BC V7H 0A7
 Phone: 604 984 0221 Fax: 604 984 0218 www.alsglobal.com

To: ATAC RESOURCES LTD.
 C/O ARCHER, CATHRO & ASSOCIATES (1981)
 LIMITED
 1016-510 W HASTINGS ST
 VANCOUVER BC V6B 1L8

Page: 9 - B
 Total # Pages: 9 (A - D)
 Plus Appendix Pages
 Finalized Date: 28-SEP-2014
 Account: RCM

Project: Area G & H

CERTIFICATE OF ANALYSIS WH14146242

Sample Description	Method Analyte Units LOR	ME-MS41	ME-MS41	ME-MS41	ME-MS41	ME-MS41	ME-MS41	ME-MS41	ME-MS41	ME-MS41	ME-MS41	ME-MS41	ME-MS41	ME-MS41	ME-MS41	
		Cs ppm	Cu ppm	Fe %	Ga ppm	Ge ppm	Hf ppm	Hg ppm	In ppm	K %	La ppm	Li ppm	Mg %	Mn ppm	Mo ppm	Na %
		0.05	0.2	0.01	0.05	0.05	0.02	0.01	0.005	0.01	0.2	0.1	0.01	5	0.05	0.01
ZZ95281		0.77	39.8	1.88	2.85	0.05	0.06	1.24	0.030	0.07	9.9	9.3	0.96	133	4.37	0.01
ZZ95282		0.46	34.1	1.99	2.79	<0.05	0.05	0.84	0.023	0.06	8.2	10.5	2.13	439	2.83	0.01
ZZ95283		0.64	31.6	1.49	1.50	<0.05	0.05	0.74	0.021	0.09	5.4	4.6	2.70	134	8.41	0.01
ZZ95284		0.57	36.1	2.24	3.33	<0.05	0.05	0.49	0.027	0.05	9.4	13.8	1.51	514	0.81	0.01
ZZ95285		0.58	27.7	2.03	2.87	0.05	0.04	0.98	0.026	0.06	9.1	9.5	2.20	390	2.67	0.01
ZZ95286		1.14	11.9	2.32	5.17	0.05	0.02	2.72	0.030	0.05	12.6	10.5	0.22	283	2.39	0.01
ZZ95287		0.76	19.5	1.10	2.14	<0.05	0.03	0.42	0.015	0.04	6.1	4.3	0.20	225	1.03	0.01
ZZ95288		0.52	27.0	1.69	2.28	<0.05	0.04	0.86	0.024	0.06	8.0	6.1	1.96	305	3.54	0.01
ZZ95289		0.56	28.8	1.61	2.30	0.05	0.05	1.05	0.023	0.06	7.5	6.8	1.82	167	1.71	0.01
ZZ95290		0.63	25.5	1.64	2.02	<0.05	0.03	0.94	0.021	0.08	7.9	6.1	3.56	153	3.76	0.02

***** See Appendix Page for comments regarding this certificate *****



ALS Canada Ltd.
 2103 Dollarton Hwy
 North Vancouver BC V7H 0A7
 Phone: 604 984 0221 Fax: 604 984 0218 www.alsglobal.com

To: ATAC RESOURCES LTD.
 C/O ARCHER, CATHRO & ASSOCIATES (1981)
 LIMITED
 1016-510 W HASTINGS ST
 VANCOUVER BC V6B 1L8

Page: 9 - C
 Total # Pages: 9 (A - D)
 Plus Appendix Pages
 Finalized Date: 28-SEP-2014
 Account: RCM

Project: Area G & H

CERTIFICATE OF ANALYSIS WH14146242

Sample Description	Method Analyte Units LOR	ME-MS41	ME-MS41	ME-MS41	ME-MS41	ME-MS41	ME-MS41	ME-MS41	ME-MS41	ME-MS41	ME-MS41	ME-MS41	ME-MS41	ME-MS41	ME-MS41	
		Nb ppm	Ni ppm	P ppm	Pb ppm	Rb ppm	Re ppm	S %	Sb ppm	Sc ppm	Se ppm	Sn ppm	Sr ppm	Ta ppm	Te ppm	Th ppm
		0.05	0.2	10	0.2	0.1	0.001	0.01	0.05	0.1	0.2	0.2	0.2	0.01	0.01	0.2
ZZ95281		0.35	53.5	1170	11.2	7.2	0.008	0.08	3.05	3.9	3.3	0.4	63.3	<0.01	0.10	1.8
ZZ95282		0.42	43.9	1180	10.2	5.3	0.008	0.07	2.04	2.5	3.2	0.3	66.4	<0.01	0.05	0.8
ZZ95283		0.14	41.9	1070	7.8	5.8	0.010	0.11	3.34	2.8	4.6	0.3	136.0	<0.01	0.10	1.4
ZZ95284		0.45	29.7	1070	12.7	6.6	0.002	0.08	1.34	2.6	1.7	0.4	52.0	<0.01	0.02	0.8
ZZ95285		0.39	41.1	1080	10.8	6.5	0.001	0.05	1.94	3.0	1.8	0.4	68.6	<0.01	0.04	1.2
ZZ95286		0.85	23.5	570	16.2	11.2	0.001	0.04	2.55	2.8	0.7	0.6	21.8	<0.01	0.04	1.3
ZZ95287		0.40	22.8	740	6.8	5.1	0.001	0.11	0.97	1.0	1.2	0.3	49.1	<0.01	0.04	0.2
ZZ95288		0.26	43.9	1180	9.2	6.3	0.002	0.07	2.11	2.2	3.0	0.3	83.7	<0.01	0.05	0.6
ZZ95289		0.31	36.9	1100	8.8	6.0	0.003	0.07	1.59	2.5	2.6	0.3	73.6	<0.01	0.04	0.9
ZZ95290		0.26	41.7	1150	8.1	6.3	0.004	0.04	2.05	2.9	2.3	0.3	113.0	<0.01	0.07	1.6

***** See Appendix Page for comments regarding this certificate *****



ALS Canada Ltd.
 2103 Dollarton Hwy
 North Vancouver BC V7H 0A7
 Phone: 604 984 0221 Fax: 604 984 0218 www.alsglobal.com

To: ATAC RESOURCES LTD.
 C/O ARCHER, CATHRO & ASSOCIATES (1981)
 LIMITED
 1016-510 W HASTINGS ST
 VANCOUVER BC V6B 1L8

Page: 9 - D
 Total # Pages: 9 (A - D)
 Plus Appendix Pages
 Finalized Date: 28-SEP-2014
 Account: RCM

Project: Area G & H

CERTIFICATE OF ANALYSIS WH14146242

Sample Description	Method Analyte Units LOR	ME-MS41	ME-MS41	ME-MS41	ME-MS41	ME-MS41	ME-MS41	ME-MS41	ME-MS41
		Ti %	Ti ppm	U ppm	V ppm	W ppm	Y ppm	Zn ppm	Zr ppm
		0.005	0.02	0.05	1	0.05	0.05	2	0.5
ZZ95281		0.007	0.56	2.83	110	0.11	18.10	179	2.8
ZZ95282		0.008	0.22	3.96	52	0.11	14.25	152	1.7
ZZ95283		<0.005	0.82	2.62	82	0.11	14.90	164	2.1
ZZ95284		0.011	0.27	1.98	41	0.13	12.40	111	1.8
ZZ95285		0.010	0.32	2.13	58	0.12	14.40	122	1.6
ZZ95286		0.022	0.36	3.47	68	0.19	9.15	210	0.6
ZZ95287		0.012	0.16	2.06	31	0.06	9.73	103	1.2
ZZ95288		0.006	0.28	2.83	55	0.32	16.80	140	1.6
ZZ95289		0.007	0.27	2.93	50	0.07	15.40	120	1.9
ZZ95290		0.008	0.33	2.41	51	0.17	15.35	150	1.3

***** See Appendix Page for comments regarding this certificate *****



ALS Canada Ltd.
2103 Dollarton Hwy
North Vancouver BC V7H 0A7
Phone: 604 984 0221 Fax: 604 984 0218 www.alsglobal.com

To: ATAC RESOURCES LTD.
C/O ARCHER, CATHRO & ASSOCIATES (1981)
LIMITED
1016-510 W HASTINGS ST
VANCOUVER BC V6B 1L8

Page: Appendix 1
Total # Appendix Pages: 1
Finalized Date: 28-SEP-2014
Account: RCM

Project: Area G & H

CERTIFICATE OF ANALYSIS WH14146242

CERTIFICATE COMMENTS	
	<p style="text-align: center;">ANALYTICAL COMMENTS</p> <p>Applies to Method: Gold determinations by this method are semi-quantitative due to the small sample weight used (0.5g). ME-MS41</p> <p style="text-align: center;">LABORATORY ADDRESSES</p> <p>Applies to Method: Processed at ALS Whitehorse located at 78 Mt. Sima Rd, Whitehorse, YT, Canada. LOG-22 SCR-41 WEI-21</p> <p>Applies to Method: Processed at ALS Vancouver located at 2103 Dollarton Hwy, North Vancouver, BC, Canada. Au-ICP21 ME-MS41</p>



ALS Canada Ltd.
 2103 Dollarton Hwy
 North Vancouver BC V7H 0A7
 Phone: 604 984 0221 Fax: 604 984 0218 www.alsglobal.com

To: ATAC RESOURCES LTD.
 C/O ARCHER, CATHRO & ASSOCIATES (1981)
 LIMITED
 1016-510 W HASTINGS ST
 VANCOUVER BC V6B 1L8

Page: 1
 Total # Pages: 8 (A - D)
 Plus Appendix Pages
 Finalized Date: 30-SEP-2014
 Account: RCM

CERTIFICATE WH14146243

Project: Area G & H

This report is for 250 Soil samples submitted to our lab in Whitehorse, YT, Canada on 16-SEP-2014.

The following have access to data associated with this certificate:

ROB CARNE	JULIA LANE	JOAN MARIACHER
-----------	------------	----------------

SAMPLE PREPARATION	
ALS CODE	DESCRIPTION
WEI-21	Received Sample Weight
LOG-22	Sample login - Rcd w/o BarCode
SCR-41	Screen to -180um and save both

ANALYTICAL PROCEDURES		
ALS CODE	DESCRIPTION	INSTRUMENT
Au-ICP21	Au 30g FA ICP-AES Finish	ICP-AES
ME-MS41	51 anal. aqua regia ICPMS	

To: ATAC RESOURCES LTD.
 ATTN: JULIA LANE
 C/O ARCHER, CATHRO & ASSOCIATES (1981) LIMITED
 1016-510 W HASTINGS ST
 VANCOUVER BC V6B 1L8

This is the Final Report and supersedes any preliminary report with this certificate number. Results apply to samples as submitted. All pages of this report have been checked and approved for release.

***** See Appendix Page for comments regarding this certificate *****

Signature: 
 Colin Ramshaw, Vancouver Laboratory Manager



ALS Canada Ltd.
 2103 Dollarton Hwy
 North Vancouver BC V7H 0A7
 Phone: 604 984 0221 Fax: 604 984 0218 www.alsglobal.com

To: ATAC RESOURCES LTD.
 C/O ARCHER, CATHRO & ASSOCIATES (1981)
 LIMITED
 1016-510 W HASTINGS ST
 VANCOUVER BC V6B 1L8

Page: 2 - D
 Total # Pages: 8 (A - D)
 Plus Appendix Pages
 Finalized Date: 30-SEP-2014
 Account: RCM

Project: Area G & H

CERTIFICATE OF ANALYSIS WH14146243

Sample Description	Method Analyte Units LOR	ME-MS41	ME-MS41	ME-MS41	ME-MS41	ME-MS41	ME-MS41	ME-MS41	ME-MS41
		Ti %	Ti ppm	U ppm	V ppm	W ppm	Y ppm	Zn ppm	Zr ppm
		0.005	0.02	0.05	1	0.05	0.05	2	0.5
ZZ96251		0.013	0.41	3.03	242	0.19	9.44	728	0.8
ZZ96252		0.014	0.50	3.56	270	0.24	10.90	708	1.0
ZZ96253		0.011	0.39	2.83	210	0.16	8.38	533	0.9
ZZ96254		0.012	0.44	4.29	265	0.26	13.30	794	1.0
ZZ96255		0.011	0.38	3.77	242	0.21	10.70	656	0.8
ZZ96256		0.017	0.62	5.15	410	0.24	15.70	953	1.0
ZZ96257		0.017	0.43	4.11	308	0.17	11.20	636	1.0
ZZ96258		0.019	0.49	5.06	350	0.27	16.85	1040	1.9
ZZ96259		0.012	0.40	4.13	215	0.22	12.35	583	1.5
ZZ96260		0.013	0.42	4.19	235	0.22	12.75	696	1.5
ZZ96261		0.017	1.13	3.80	442	0.36	21.2	1040	2.0
ZZ96262		0.012	0.58	4.07	256	0.28	15.75	611	2.1
ZZ96263		0.013	0.62	3.59	241	0.22	15.30	671	2.8
ZZ96264		0.013	0.57	4.51	236	0.21	16.30	888	3.5
ZZ96265		0.018	0.11	1.07	54	0.23	16.15	105	0.7
ZZ96266		0.012	0.33	0.98	164	0.31	18.30	222	1.3
ZZ96267		<0.005	0.24	0.54	40	0.11	8.86	118	1.1
ZZ96268		0.023	1.80	4.39	94	0.32	17.60	119	2.0
ZZ96269		0.016	1.09	2.94	87	0.47	24.8	164	3.8
ZZ96270		0.013	0.29	1.53	71	0.37	15.45	112	0.6
ZZ96271		0.011	0.30	1.25	57	0.14	13.50	162	1.4
ZZ96272		0.015	0.21	1.33	80	0.16	16.20	169	1.0
ZZ96273		0.007	0.17	1.27	59	0.08	10.50	129	1.2
ZZ96274		0.015	0.22	1.15	88	0.22	12.65	104	1.0
ZZ96275		0.009	0.37	1.87	127	0.19	22.5	118	1.5
ZZ96276		0.013	0.18	1.74	54	0.17	14.40	125	0.9
ZZ96277		0.005	0.24	0.85	19	0.08	17.50	76	1.0
ZZ96278		0.007	0.20	1.09	18	0.10	13.50	72	0.8
ZZ96279		0.016	0.13	2.47	56	0.15	9.06	148	0.8
ZZ96280		0.021	0.17	1.24	59	0.20	6.24	138	0.9
ZZ96281		0.013	0.19	2.05	68	0.20	20.4	104	1.3
ZZ96282		0.022	0.20	0.98	70	0.25	7.33	90	2.3
ZZ96283		0.009	0.18	1.14	66	0.23	14.70	177	1.2
ZZ96284		0.016	1.28	2.15	86	0.19	7.26	333	<0.5
ZZ96285		0.032	0.82	2.96	236	0.18	23.5	792	1.2
ZZ96286		0.026	3.37	7.89	523	0.31	31.4	1300	1.1
ZZ96287		0.013	1.37	10.35	592	0.29	16.80	663	1.8
ZZ96288		0.031	0.93	4.51	395	0.26	11.90	240	0.8
ZZ96289		0.014	0.37	2.52	296	0.21	10.10	387	0.6
ZZ96290		0.013	0.41	3.43	156	0.14	17.30	780	2.3



ALS Canada Ltd.
 2103 Dollarton Hwy
 North Vancouver BC V7H 0A7
 Phone: 604 984 0221 Fax: 604 984 0218 www.alsglobal.com

To: ATAC RESOURCES LTD.
 C/O ARCHER, CATHRO & ASSOCIATES (1981)
 LIMITED
 1016-510 W HASTINGS ST
 VANCOUVER BC V6B 1L8

Page: 3 - D
 Total # Pages: 8 (A - D)
 Plus Appendix Pages
 Finalized Date: 30-SEP-2014
 Account: RCM

Project: Area G & H

CERTIFICATE OF ANALYSIS WH14146243

Sample Description	Method Analyte Units LOR	ME-MS41	ME-MS41	ME-MS41	ME-MS41	ME-MS41	ME-MS41	ME-MS41	ME-MS41
		Ti %	Ti ppm	U ppm	V ppm	W ppm	Y ppm	Zn ppm	Zr ppm
		0.005	0.02	0.05	1	0.05	0.05	2	0.5
ZZ96291		0.046	2.23	6.60	2030	0.48	18.30	3430	2.9
ZZ96292		0.008	0.24	3.86	336	0.16	20.8	2020	2.2
ZZ96293		0.012	0.27	1.31	101	0.16	13.90	268	1.5
ZZ96294		0.019	0.25	0.73	97	0.23	4.49	136	0.9
ZZ96295		0.008	0.32	3.76	65	0.12	19.40	158	1.4
ZZ96296		0.009	0.53	9.34	37	0.17	36.1	189	1.7
ZZ96297		0.006	0.29	1.69	92	0.07	14.85	1060	1.6
ZZ96298		0.007	0.19	1.40	41	0.08	10.10	311	1.7
ZZ96299		0.009	0.36	1.82	64	0.15	14.00	430	1.0
ZZ96300		0.013	0.27	2.12	80	0.17	12.90	321	1.7
ZZ96301		0.014	0.11	1.35	74	0.16	6.63	222	0.7
ZZ96302		0.009	0.24	1.53	126	0.15	10.95	202	2.3
ZZ96303		0.017	0.23	1.03	112	0.26	4.68	191	1.8
ZZ96304		0.016	0.14	1.38	64	0.23	10.65	91	0.9
ZZ96305		0.020	0.27	1.11	78	0.18	5.61	298	<0.5
ZZ96306		0.018	0.16	0.96	42	0.18	10.60	220	0.8
ZZ96307		0.011	0.20	1.79	79	0.17	9.64	232	1.7
ZZ96308		0.007	0.32	3.08	173	0.16	8.09	199	1.7
ZZ96309		0.013	0.31	7.86	160	0.24	13.00	970	1.6
ZZ96310		0.020	0.32	3.35	129	0.31	7.13	227	<0.5
ZZ96311		0.016	0.37	4.01	98	0.20	8.20	188	1.5
ZZ96312		0.017	7.25	12.35	2900	0.90	27.1	448	1.5
ZZ96313		0.009	0.61	2.78	293	0.20	9.81	443	0.9
ZZ96314		<0.005	0.18	1.14	58	<0.05	8.67	404	3.2
ZZ96315		<0.005	0.14	1.34	43	<0.05	9.63	337	2.8
ZZ96316		<0.005	0.07	1.32	28	<0.05	9.07	239	4.7
ZZ96317		0.023	0.32	3.74	220	0.22	18.40	499	1.5
ZZ96318		0.010	0.46	2.48	190	0.19	16.70	429	2.7
ZZ96319		0.017	0.25	2.27	104	0.32	11.05	199	1.7
ZZ96320		0.018	0.22	2.14	91	0.24	11.65	182	1.1
ZZ96321		0.006	0.53	1.76	103	0.15	14.25	333	2.5
ZZ96322		0.006	0.78	1.79	102	0.17	14.90	381	3.0
ZZ96323		0.006	0.67	1.80	58	0.16	15.10	331	2.7
ZZ96324		0.009	0.26	4.02	49	0.18	21.5	428	1.6
ZZ96325		0.007	0.31	1.24	60	0.14	11.35	165	2.2
ZZ96326		0.007	0.32	1.41	47	0.10	10.25	212	2.1
ZZ96327		0.006	0.23	1.29	34	0.07	9.20	165	1.7
ZZ96328		0.005	0.25	1.57	41	0.09	11.15	223	1.4
ZZ96329		0.007	0.24	1.67	46	0.10	11.15	200	2.3
ZZ96330		0.009	0.19	1.16	50	0.11	13.10	160	1.6



ALS Canada Ltd.
 2103 Dollarton Hwy
 North Vancouver BC V7H 0A7
 Phone: 604 984 0221 Fax: 604 984 0218 www.alsglobal.com

To: ATAC RESOURCES LTD.
 C/O ARCHER, CATHRO & ASSOCIATES (1981)
 LIMITED
 1016-510 W HASTINGS ST
 VANCOUVER BC V6B 1L8

Page: 4 - D
 Total # Pages: 8 (A - D)
 Plus Appendix Pages
 Finalized Date: 30-SEP-2014
 Account: RCM

Project: Area G & H

CERTIFICATE OF ANALYSIS WH14146243

Sample Description	Method Analyte Units LOR	ME-MS41	ME-MS41	ME-MS41	ME-MS41	ME-MS41	ME-MS41	ME-MS41	ME-MS41
		Ti %	Ti ppm	U ppm	V ppm	W ppm	Y ppm	Zn ppm	Zr ppm
		0.005	0.02	0.05	1	0.05	0.05	2	0.5
ZZ96331		0.010	0.20	1.24	39	0.10	11.05	132	1.5
ZZ96332		0.007	0.17	1.33	33	0.07	9.28	140	1.3
ZZ96333		0.011	0.13	1.02	37	0.09	10.20	132	1.7
ZZ96334		0.010	0.30	1.49	40	0.11	12.45	230	1.5
ZZ96335		0.005	0.12	0.89	20	0.05	7.91	131	1.2
ZZ96336		0.006	0.16	0.88	27	0.07	10.15	178	1.8
ZZ96337		<0.005	0.11	1.12	19	<0.05	9.08	113	1.6
ZZ96338		0.005	0.16	0.95	27	0.06	10.95	152	1.5
ZZ96339		0.008	0.21	1.32	32	0.07	11.80	204	2.1
ZZ96340		0.005	0.12	0.91	19	0.06	7.44	129	1.4
ZZ96341		0.007	0.08	3.06	27	0.07	7.77	113	1.4
ZZ96342		0.056	0.26	1.36	148	0.15	14.15	186	1.9
ZZ96343		0.033	0.23	1.42	85	0.25	11.10	141	1.9
ZZ96344		0.015	0.18	1.37	61	0.26	11.70	221	0.7
ZZ96345		0.021	0.27	2.51	131	0.26	15.90	158	1.4
ZZ96346		0.500	0.81	0.91	265	0.26	16.30	87	11.8
ZZ96347		0.423	0.25	0.88	173	0.20	10.10	122	5.8
ZZ96348		0.094	0.37	1.57	127	0.19	13.10	249	2.1
ZZ96349		0.015	0.48	1.47	87	0.11	11.15	250	1.4
ZZ96350		0.009	0.38	4.60	191	0.19	13.40	528	1.8
ZZ96351		0.010	0.19	1.51	71	0.16	14.20	205	1.9
ZZ96352		<0.005	0.27	1.81	49	0.10	19.50	257	1.6
ZZ96353		0.010	0.27	1.86	61	0.18	15.25	145	1.5
ZZ96354		0.012	0.16	1.34	44	0.14	11.20	144	1.3
ZZ96355		0.017	0.62	1.95	67	0.28	9.83	223	1.2
ZZ96356		0.008	0.34	0.69	49	0.23	18.70	115	1.6
ZZ96357		0.017	0.22	0.57	79	0.17	3.73	78	1.7
ZZ96358		0.011	0.08	0.98	30	0.11	3.88	22	0.8
ZZ96359		0.012	0.09	2.15	41	0.08	4.33	85	0.6
ZZ96360		0.005	0.12	1.07	22	0.05	8.02	118	1.5
ZZ96361		0.014	0.20	1.03	25	0.07	8.03	115	1.5
ZZ96362		0.012	0.31	2.57	34	0.06	9.78	105	1.7
ZZ96363		0.010	0.15	3.81	37	0.10	9.02	119	1.5
ZZ96364		0.027	0.11	3.70	51	0.23	9.24	83	0.8
ZZ96365		0.008	0.29	0.51	30	<0.05	8.14	63	0.9
ZZ96366		0.017	0.13	0.99	38	0.22	11.20	87	1.4
ZZ96367		0.016	0.13	0.78	38	0.13	7.79	130	1.0
ZZ96368		0.016	0.16	0.76	41	0.16	8.48	153	1.2
ZZ96369		0.017	0.13	1.49	33	0.21	9.81	89	1.3
ZZ96370		0.023	0.31	2.45	65	0.22	3.15	343	0.8



ALS Canada Ltd.
 2103 Dollarton Hwy
 North Vancouver BC V7H 0A7
 Phone: 604 984 0221 Fax: 604 984 0218 www.alsglobal.com

To: ATAC RESOURCES LTD.
 C/O ARCHER, CATHRO & ASSOCIATES (1981)
 LIMITED
 1016-510 W HASTINGS ST
 VANCOUVER BC V6B 1L8

Page: 5 - D
 Total # Pages: 8 (A - D)
 Plus Appendix Pages
 Finalized Date: 30-SEP-2014
 Account: RCM

Project: Area G & H

CERTIFICATE OF ANALYSIS WH14146243

Sample Description	Method	ME-MS41	ME-MS41	ME-MS41	ME-MS41	ME-MS41	ME-MS41	ME-MS41	ME-MS41
	Analyte	Ti	Ti	U	V	W	Y	Zn	Zr
Units		%	ppm	ppm	ppm	ppm	ppm	ppm	ppm
LOR		0.005	0.02	0.05	1	0.05	0.05	2	0.5
ZZ96371		0.013	0.25	4.46	47	0.18	12.10	105	1.1
ZZ96372		0.006	0.13	1.04	19	0.06	6.58	116	1.4
ZZ96373		0.005	0.10	1.00	14	<0.05	5.44	83	1.1
ZZ96374		0.009	0.12	0.90	33	0.09	11.30	84	1.8
ZZ96375		0.013	0.11	0.80	36	0.11	7.73	94	1.1
ZZ96376		0.019	0.07	1.19	52	0.21	10.35	68	1.0
ZZ96377		0.033	0.14	0.38	105	0.19	6.72	106	1.2
ZZ96378		0.012	0.08	1.13	24	0.08	8.16	96	1.0
ZZ96379		0.017	0.13	0.87	35	0.16	10.45	90	1.6
ZZ96380		<0.005	0.11	1.01	13	0.05	8.04	82	1.6
ZZ96381		0.007	0.13	0.90	24	0.07	8.57	84	1.9
ZZ96382		0.006	0.18	1.05	31	0.07	13.50	102	2.3
ZZ96383		0.017	0.10	1.09	39	0.20	11.05	238	1.1
ZZ96384		0.008	0.14	0.86	26	0.11	9.24	144	2.0
ZZ96385		0.014	0.16	0.57	51	0.14	10.50	166	1.8
ZZ96386		0.013	0.17	0.72	40	0.13	9.83	135	1.9
ZZ96387		0.019	0.20	0.54	58	0.15	10.35	358	2.0
ZZ96388		0.020	0.17	0.64	47	0.14	10.85	178	1.4
ZZ96389		0.015	0.16	0.80	42	0.16	12.80	147	1.7
ZZ96390		0.017	0.13	0.78	50	0.17	9.46	168	1.5
ZZ96391		0.015	0.15	0.94	55	0.18	13.60	153	1.7
ZZ96392		0.005	0.10	1.00	15	0.05	5.72	86	1.3
ZZ96393		<0.005	0.19	1.23	27	0.06	8.95	109	1.9
ZZ96394		0.006	0.28	1.42	34	0.11	10.10	143	2.6
ZZ96395		0.006	0.15	1.09	26	0.07	9.65	96	1.8
ZZ96396		0.013	0.13	0.82	31	0.16	8.84	115	1.6
ZZ96397		0.015	0.17	0.88	38	0.26	13.95	115	1.8
ZZ96398		0.023	0.20	0.69	52	0.20	10.45	143	2.1
ZZ96399		0.009	0.14	1.03	37	0.14	10.60	114	1.2
ZZ96400		0.025	0.16	0.81	53	0.19	10.55	177	2.4
ZZ96401		0.007	0.11	1.22	30	0.09	10.75	113	1.7
ZZ96402		0.015	0.11	0.80	28	0.13	9.06	99	1.3
ZZ96403		0.010	0.15	0.90	39	0.14	14.55	109	1.6
ZZ96404		0.015	0.20	0.82	21	0.12	7.44	88	1.2
ZZ96405		0.013	0.17	1.16	48	0.19	14.70	121	2.3
ZZ96406		0.024	0.16	0.82	44	0.18	8.42	117	1.5
ZZ96407		0.031	0.15	0.73	53	0.23	10.60	130	1.9
ZZ96408		0.009	0.18	1.00	23	0.07	8.21	80	1.7
ZZ96409		0.008	0.53	2.75	59	0.06	15.60	205	3.0
ZZ96410		0.009	0.36	2.42	54	0.06	15.45	193	2.1



ALS Canada Ltd.
 2103 Dollarton Hwy
 North Vancouver BC V7H 0A7
 Phone: 604 984 0221 Fax: 604 984 0218 www.alsglobal.com

To: ATAC RESOURCES LTD.
 C/O ARCHER, CATHRO & ASSOCIATES (1981)
 LIMITED
 1016-510 W HASTINGS ST
 VANCOUVER BC V6B 1L8

Page: 6 - A
 Total # Pages: 8 (A - D)
 Plus Appendix Pages
 Finalized Date: 30-SEP-2014
 Account: RCM

Project: Area G & H

CERTIFICATE OF ANALYSIS WH14146243

Sample Description	Method	WEI-21	Au-ICP21	ME-MS41	ME-MS41	ME-MS41	ME-MS41	ME-MS41	ME-MS41	ME-MS41	ME-MS41	ME-MS41	ME-MS41	ME-MS41	ME-MS41	ME-MS41
	Analyte	Recvd Wt.	Au	Ag	Al	As	Au	B	Ba	Be	Bi	Ca	Cd	Ce	Co	Cr
Units		kg	ppm	ppm	%	ppm	ppm	ppm	ppm	ppm	ppm	%	ppm	ppm	ppm	ppm
LOR		0.02	0.001	0.01	0.01	0.1	0.2	10	10	0.05	0.01	0.01	0.01	0.02	0.1	1
ZZ96411		0.28	0.004	0.58	0.80	27.4	<0.2	<10	640	0.67	0.21	1.97	1.84	32.5	16.9	57
ZZ96412		0.25	0.005	0.61	0.71	25.2	<0.2	<10	940	0.57	0.19	1.62	2.15	29.7	13.8	38
ZZ96413		0.25	0.004	0.47	0.70	25.4	<0.2	<10	900	0.55	0.18	2.03	1.35	30.1	12.9	43
ZZ96414		0.26	0.004	0.43	0.67	24.5	<0.2	<10	740	0.53	0.17	2.29	1.74	31.7	13.1	44
ZZ96415		0.15	0.004	0.43	0.60	22.2	<0.2	<10	780	0.44	0.16	3.66	1.40	25.8	9.6	41
ZZ96416		0.17	0.006	0.39	0.60	22.2	<0.2	<10	820	0.48	0.15	3.05	1.24	25.6	8.8	44
ZZ96417		0.18	0.004	0.39	0.61	22.2	<0.2	<10	760	0.50	0.16	3.00	1.56	27.7	12.5	46
ZZ96418		0.21	0.004	0.40	0.67	21.2	<0.2	<10	720	0.47	0.17	2.55	1.42	28.3	12.1	49
ZZ96419		0.19	0.001	0.20	0.50	8.5	<0.2	<10	100	0.36	0.09	11.75	0.41	13.00	5.1	12
ZZ96420		0.21	<0.001	0.19	0.62	13.2	<0.2	<10	200	0.56	0.12	10.70	0.67	20.9	6.0	15
ZZ96421		0.15	0.001	0.27	0.74	20.7	<0.2	<10	830	0.48	0.11	6.45	2.39	16.80	6.9	30
ZZ96422		0.32	0.001	0.44	1.61	23.4	<0.2	<10	650	0.81	0.20	1.72	0.80	33.8	10.1	38
ZZ96423		0.20	0.003	0.58	0.94	16.3	<0.2	<10	980	0.67	0.22	1.01	1.28	36.7	13.2	49
ZZ96424		0.27	0.003	0.35	0.87	24.8	<0.2	<10	420	0.78	0.23	1.40	1.44	32.2	18.5	77
ZZ96425		0.24	0.005	0.59	0.94	32.9	<0.2	<10	760	0.77	0.24	1.52	2.27	37.9	20.0	55
ZZ96426		0.27	0.035	0.36	0.79	27.7	<0.2	<10	550	0.65	0.23	1.40	1.65	30.7	17.9	66
ZZ96427		0.19	0.002	0.73	0.65	14.4	<0.2	<10	630	0.62	0.11	6.72	1.70	17.20	6.2	35
ZZ96428		0.31	0.001	0.44	0.80	14.7	<0.2	<10	500	0.48	0.12	4.05	1.10	22.9	8.7	38
ZZ96429		0.29	0.001	0.23	0.91	15.0	<0.2	<10	300	0.56	0.12	9.71	0.62	19.30	7.2	21
ZZ96430		0.37	0.001	0.20	1.01	10.7	<0.2	<10	230	0.58	0.15	6.03	0.50	22.2	8.8	23
ZZ96431		0.25	0.001	0.05	1.90	14.7	<0.2	<10	280	0.79	0.26	1.19	0.18	40.2	9.6	32
ZZ96432		0.32	0.002	0.20	1.29	10.8	<0.2	<10	360	0.62	0.22	2.94	0.39	30.3	9.3	26
ZZ96433		0.27	<0.001	0.36	0.85	7.5	<0.2	<10	360	0.57	0.15	4.74	1.19	20.2	7.4	21
ZZ96434		0.31	0.003	0.44	0.75	24.3	<0.2	<10	560	0.61	0.20	2.30	1.53	33.2	15.5	62
ZZ96435		0.29	0.005	0.38	0.81	27.9	<0.2	<10	670	0.59	0.21	2.14	2.05	34.4	19.6	71
ZZ96436		0.23	0.005	0.35	0.86	26.3	<0.2	<10	470	0.69	0.21	1.13	1.44	34.8	20.4	82
ZZ96437		0.27	<0.001	0.32	0.77	21.0	<0.2	<10	560	0.58	0.19	3.64	1.24	28.5	15.2	60
ZZ96438		0.25	0.004	0.43	0.86	26.0	<0.2	<10	620	0.65	0.20	1.46	1.81	35.0	17.4	73
ZZ96439		0.23	0.004	0.41	0.92	29.8	<0.2	<10	620	0.70	0.21	1.72	1.48	38.9	19.0	77
ZZ96440		0.31	0.006	0.59	0.91	27.6	<0.2	<10	750	0.70	0.23	1.25	2.17	35.1	17.1	51
ZZ96441		0.26	0.006	0.64	1.00	33.0	<0.2	<10	710	0.77	0.25	1.37	2.13	36.8	20.2	59
ZZ96442		0.25	0.001	0.22	0.80	11.7	<0.2	<10	200	0.57	0.14	9.93	0.79	17.65	8.3	15
ZZ96443		0.16	<0.001	0.19	1.24	11.9	<0.2	<10	210	0.62	0.20	3.32	0.27	26.9	6.3	21
ZZ96444		0.28	0.003	0.65	0.61	25.6	<0.2	<10	590	0.50	0.17	2.62	2.65	23.3	13.0	44
ZZ96445		0.25	0.008	0.46	0.82	25.4	<0.2	<10	750	0.62	0.21	1.90	1.47	32.4	16.2	58
ZZ96446		0.24	0.005	0.56	0.91	31.6	<0.2	<10	750	0.68	0.23	1.66	2.22	34.8	19.6	57
ZZ96447		0.14	0.005	0.40	0.66	19.8	<0.2	<10	710	0.52	0.17	2.39	2.26	25.1	14.2	41
ZZ96448		0.13	0.006	0.46	0.77	23.3	<0.2	<10	630	0.62	0.20	2.00	1.85	25.4	13.2	41
ZZ96449		0.26	0.004	0.57	0.63	20.7	<0.2	<10	780	0.52	0.17	4.22	1.52	24.8	9.6	31
ZZ96450		0.20	0.009	0.50	0.65	19.8	<0.2	<10	730	0.54	0.17	4.07	1.87	27.2	12.0	33



ALS Canada Ltd.
 2103 Dollarton Hwy
 North Vancouver BC V7H 0A7
 Phone: 604 984 0221 Fax: 604 984 0218 www.alsglobal.com

To: ATAC RESOURCES LTD.
 C/O ARCHER, CATHRO & ASSOCIATES (1981)
 LIMITED
 1016-510 W HASTINGS ST
 VANCOUVER BC V6B 1L8

Page: 6 - B
 Total # Pages: 8 (A - D)
 Plus Appendix Pages
 Finalized Date: 30-SEP-2014
 Account: RCM

Project: Area G & H

CERTIFICATE OF ANALYSIS WH14146243

Sample Description	Method	ME-MS41	ME-MS41	ME-MS41	ME-MS41	ME-MS41	ME-MS41	ME-MS41	ME-MS41	ME-MS41	ME-MS41	ME-MS41	ME-MS41	ME-MS41	ME-MS41	ME-MS41
	Analyte	Cs	Cu	Fe	Ga	Ge	Hf	Hg	In	K	La	Li	Mg	Mn	Mo	Na
Units		ppm	ppm	%	ppm	ppm	ppm	ppm	ppm	%	ppm	ppm	%	ppm	ppm	%
LOR		0.05	0.2	0.01	0.05	0.05	0.02	0.01	0.005	0.01	0.2	0.1	0.01	5	0.05	0.01
ZZ96411		2.15	62.5	3.10	2.76	0.07	0.06	0.25	0.029	0.11	17.6	15.5	1.56	598	5.15	<0.01
ZZ96412		2.40	68.5	2.69	2.35	0.07	0.08	0.26	0.027	0.12	16.8	11.5	0.88	634	6.81	0.01
ZZ96413		2.28	45.5	2.70	2.31	0.07	0.06	0.19	0.028	0.11	16.6	10.4	1.39	524	5.22	0.01
ZZ96414		2.15	55.4	2.64	2.33	0.09	0.05	0.20	0.027	0.12	17.5	11.0	1.54	471	5.36	0.01
ZZ96415		2.16	52.2	2.41	2.01	0.07	0.06	0.20	0.024	0.11	14.9	10.2	1.88	401	5.06	0.01
ZZ96416		2.01	43.6	2.41	2.02	0.08	0.06	0.20	0.024	0.10	15.1	9.8	1.74	327	4.47	0.01
ZZ96417		2.20	50.8	2.56	2.06	0.07	0.06	0.20	0.022	0.11	15.4	9.9	1.64	473	4.84	0.01
ZZ96418		1.96	46.5	2.60	2.21	0.07	0.05	0.19	0.025	0.10	15.4	11.4	1.61	542	4.30	0.01
ZZ96419		0.68	14.0	1.51	1.53	<0.05	0.04	0.08	0.016	0.05	6.9	8.5	4.85	250	1.34	0.01
ZZ96420		0.81	16.7	1.96	1.78	0.05	0.03	0.09	0.025	0.06	11.3	7.5	4.86	459	1.60	0.01
ZZ96421		0.60	26.2	1.81	2.33	<0.05	0.04	0.18	0.019	0.04	9.7	9.5	3.20	395	2.37	0.01
ZZ96422		1.36	27.2	2.94	4.57	0.06	0.05	0.15	0.031	0.08	17.7	13.3	1.01	364	3.18	0.01
ZZ96423		2.04	40.6	2.51	3.08	0.07	0.06	0.21	0.029	0.12	20.3	14.8	0.79	243	2.95	0.01
ZZ96424		2.51	54.5	3.35	3.01	0.08	0.06	0.18	0.027	0.10	17.0	19.2	1.94	482	3.19	0.01
ZZ96425		3.03	71.2	3.57	3.23	0.08	0.06	0.26	0.030	0.12	20.7	15.6	1.42	749	7.29	0.01
ZZ96426		2.61	57.3	3.30	2.71	0.07	0.03	0.24	0.031	0.10	16.5	14.4	1.63	494	4.15	0.01
ZZ96427		1.00	62.5	1.66	1.68	0.05	0.03	0.24	0.020	0.06	14.0	7.7	3.03	333	2.63	0.01
ZZ96428		0.97	25.2	2.08	2.48	0.06	0.06	0.15	0.020	0.07	13.2	13.0	2.43	156	2.32	0.01
ZZ96429		0.86	20.9	1.97	2.50	0.05	0.05	0.14	0.018	0.08	10.7	10.3	3.69	341	2.12	0.01
ZZ96430		1.01	27.7	2.29	2.90	<0.05	0.05	0.11	0.022	0.08	11.1	18.3	3.36	218	1.58	0.01
ZZ96431		1.38	16.3	3.09	5.37	0.05	0.05	0.03	0.032	0.06	16.7	14.9	0.82	359	1.60	0.01
ZZ96432		0.88	30.4	2.43	3.96	0.05	0.04	0.12	0.025	0.06	15.4	13.5	1.53	400	0.83	0.01
ZZ96433		0.67	30.6	1.80	2.56	0.05	0.07	0.19	0.019	0.07	11.2	12.1	2.11	187	0.93	0.01
ZZ96434		2.36	53.3	3.01	2.60	0.08	0.06	0.16	0.027	0.11	18.1	13.6	1.67	577	4.96	0.01
ZZ96435		2.67	61.9	3.24	2.77	0.08	0.05	0.21	0.027	0.11	18.5	13.8	1.92	929	5.20	0.01
ZZ96436		2.40	57.5	3.29	2.99	0.08	0.05	0.21	0.028	0.10	18.4	14.6	1.71	698	3.60	0.01
ZZ96437		2.13	52.9	3.03	2.61	0.07	0.08	0.16	0.025	0.11	15.1	15.7	2.10	644	4.76	0.01
ZZ96438		2.57	60.6	3.17	2.90	0.08	0.05	0.23	0.027	0.11	19.1	13.5	1.70	466	4.51	0.01
ZZ96439		2.73	59.0	3.44	3.21	0.08	0.06	0.21	0.029	0.12	20.7	15.6	2.02	346	4.36	0.01
ZZ96440		2.87	69.0	3.02	2.95	0.07	0.04	0.28	0.031	0.13	19.3	13.8	1.17	402	5.41	0.01
ZZ96441		3.44	76.0	3.51	3.37	0.08	0.05	0.34	0.034	0.14	20.2	17.2	1.35	926	6.09	0.01
ZZ96442		0.81	24.5	2.23	2.35	0.05	0.05	0.12	0.021	0.07	8.9	11.3	3.43	387	1.77	0.02
ZZ96443		0.86	9.0	2.21	4.08	0.05	0.03	0.06	0.024	0.04	17.3	8.4	1.55	337	1.45	0.01
ZZ96444		2.08	56.0	2.78	2.05	0.07	0.06	0.20	0.028	0.10	12.9	11.6	1.48	428	6.40	0.01
ZZ96445		2.32	59.2	3.09	2.78	0.07	0.05	0.26	0.026	0.11	18.0	13.3	1.70	605	4.97	0.01
ZZ96446		2.78	72.7	3.49	3.08	0.08	0.06	0.33	0.033	0.11	18.9	14.4	1.59	866	5.85	0.01
ZZ96447		1.57	56.4	2.50	2.26	0.07	0.10	0.17	0.023	0.10	13.5	11.6	1.08	855	4.08	0.01
ZZ96448		2.03	42.5	2.87	2.42	0.06	0.05	0.19	0.028	0.10	14.1	11.5	1.19	548	4.13	0.01
ZZ96449		1.97	37.0	2.58	2.16	0.07	0.06	0.21	0.023	0.10	14.7	10.5	2.41	431	5.11	0.01
ZZ96450		1.95	54.6	2.45	2.27	0.07	0.07	0.31	0.021	0.10	14.8	11.9	1.62	627	4.74	0.01



ALS Canada Ltd.
 2103 Dollarton Hwy
 North Vancouver BC V7H 0A7
 Phone: 604 984 0221 Fax: 604 984 0218 www.alsglobal.com

To: ATAC RESOURCES LTD.
 C/O ARCHER, CATHRO & ASSOCIATES (1981)
 LIMITED
 1016-510 W HASTINGS ST
 VANCOUVER BC V6B 1L8

Page: 6 - C
 Total # Pages: 8 (A - D)
 Plus Appendix Pages
 Finalized Date: 30-SEP-2014
 Account: RCM

Project: Area G & H

CERTIFICATE OF ANALYSIS WH14146243

Sample Description	Method	ME-MS41	ME-MS41	ME-MS41	ME-MS41	ME-MS41	ME-MS41	ME-MS41	ME-MS41	ME-MS41	ME-MS41	ME-MS41	ME-MS41	ME-MS41	ME-MS41	
	Analyte	Nb	Ni	P	Pb	Rb	Re	S	Sb	Sc	Se	Sn	Sr	Ta	Te	Th
Units		ppm	ppm	ppm	ppm	ppm	ppm	%	ppm	ppm	ppm	ppm	ppm	ppm	ppm	ppm
LOR		0.05	0.2	10	0.2	0.1	0.001	0.01	0.05	0.1	0.2	0.2	0.2	0.01	0.01	0.2
ZZ96411		0.64	125.5	1510	31.9	7.2	0.005	0.04	2.25	4.2	2.2	0.3	70.3	<0.01	0.08	3.4
ZZ96412		0.53	101.5	1520	39.4	9.1	0.004	0.06	3.19	3.2	2.4	0.3	73.3	<0.01	0.07	2.4
ZZ96413		0.61	85.8	1520	36.1	8.2	0.003	0.05	2.46	3.2	2.0	0.3	65.7	<0.01	0.07	2.5
ZZ96414		0.53	94.3	1760	29.7	8.0	0.005	0.09	2.50	3.5	1.9	0.3	71.8	<0.01	0.07	3.3
ZZ96415		0.46	80.6	1380	30.0	7.3	0.004	0.11	2.41	3.2	2.2	0.3	83.1	<0.01	0.08	2.4
ZZ96416		0.52	79.9	1430	34.3	7.1	0.003	0.10	2.18	3.5	1.9	0.3	80.8	<0.01	0.06	2.5
ZZ96417		0.53	91.4	1780	29.1	6.8	0.004	0.08	2.34	3.2	1.7	0.2	84.9	<0.01	0.06	2.9
ZZ96418		0.52	91.5	1620	27.4	7.1	0.004	0.06	2.01	3.2	1.8	0.2	68.1	<0.01	0.05	3.4
ZZ96419		0.20	19.0	620	12.4	3.6	<0.001	0.02	0.69	2.7	0.5	0.2	126.5	<0.01	0.02	1.7
ZZ96420		0.23	18.1	820	21.2	5.6	0.001	0.05	0.93	3.2	1.0	0.2	114.5	<0.01	0.02	0.7
ZZ96421		0.41	46.5	920	14.8	5.2	0.004	0.10	2.77	2.5	2.4	0.3	65.1	<0.01	0.04	0.9
ZZ96422		0.80	54.7	820	38.8	9.8	0.001	0.03	1.58	4.5	1.1	0.5	29.7	<0.01	0.07	3.2
ZZ96423		0.76	79.2	1490	38.1	10.6	0.002	0.05	1.43	4.2	1.8	0.4	49.2	<0.01	0.08	3.4
ZZ96424		0.84	152.5	1160	28.2	7.4	0.002	0.05	1.55	4.1	1.8	0.3	56.7	<0.01	0.04	3.4
ZZ96425		0.72	134.0	1460	32.8	9.9	0.005	0.04	2.75	4.6	2.4	0.4	58.8	<0.01	0.08	3.5
ZZ96426		0.62	138.0	1290	28.6	7.8	0.003	0.05	1.99	3.9	2.3	0.3	59.3	<0.01	0.06	3.1
ZZ96427		0.19	61.7	1280	15.9	7.0	0.002	0.07	1.44	2.1	2.0	0.2	68.2	<0.01	0.04	0.4
ZZ96428		0.40	60.8	1120	11.7	6.7	0.002	0.02	1.11	3.3	1.3	0.2	52.0	<0.01	0.04	3.0
ZZ96429		0.35	34.1	830	19.5	7.0	0.001	0.02	1.28	3.3	0.7	0.3	99.0	<0.01	0.03	2.1
ZZ96430		0.33	32.2	680	21.6	6.6	0.001	0.02	1.00	3.8	0.7	0.3	70.5	<0.01	0.02	3.1
ZZ96431		1.16	27.2	320	19.3	10.2	<0.001	0.02	0.76	4.3	0.5	0.6	25.3	<0.01	0.03	4.5
ZZ96432		0.99	25.8	630	14.2	7.4	0.001	0.03	0.83	3.8	0.9	0.5	38.2	<0.01	0.02	3.2
ZZ96433		0.48	33.9	850	14.8	6.5	0.002	0.08	1.46	3.4	2.2	0.3	59.3	<0.01	0.03	1.9
ZZ96434		0.78	117.0	1550	31.1	7.7	0.006	0.07	2.26	3.7	1.7	0.3	72.6	<0.01	0.08	3.9
ZZ96435		0.82	157.0	1580	34.0	7.9	0.003	0.05	2.34	4.0	1.7	0.3	69.4	<0.01	0.08	3.7
ZZ96436		0.94	166.5	1340	27.9	7.6	0.002	0.04	1.76	4.1	1.4	0.3	49.8	<0.01	0.07	3.0
ZZ96437		0.68	116.5	1340	22.6	7.1	0.003	0.06	1.87	3.7	1.7	0.3	84.9	<0.01	0.06	3.3
ZZ96438		0.80	150.5	1460	29.6	8.7	0.003	0.04	2.24	4.2	2.0	0.3	50.1	<0.01	0.06	3.2
ZZ96439		1.06	155.5	1530	31.3	8.9	0.003	0.03	2.07	4.4	1.6	0.3	56.0	<0.01	0.09	4.1
ZZ96440		0.62	121.5	1400	35.4	9.8	0.005	0.04	2.80	4.3	2.3	0.4	56.9	<0.01	0.10	3.3
ZZ96441		0.68	141.0	1510	38.7	10.9	0.004	0.05	2.86	5.0	2.4	0.4	58.3	<0.01	0.06	3.3
ZZ96442		0.29	25.6	670	19.9	5.3	<0.001	0.03	1.09	3.3	0.9	0.2	153.5	<0.01	0.03	2.3
ZZ96443		0.74	15.5	660	15.2	6.7	<0.001	0.02	0.65	3.2	0.7	0.5	46.6	<0.01	0.04	1.8
ZZ96444		0.32	101.0	1580	28.3	6.5	0.011	0.12	3.03	3.6	2.7	0.3	76.3	<0.01	0.09	3.0
ZZ96445		0.61	125.5	1590	31.8	7.8	0.003	0.05	2.35	4.0	2.2	0.3	63.9	<0.01	0.07	3.3
ZZ96446		0.63	140.0	1470	36.1	8.7	0.002	0.05	2.71	4.5	1.8	0.3	56.8	<0.01	0.09	3.2
ZZ96447		0.54	95.8	1370	26.4	7.8	0.004	0.08	2.38	3.0	2.4	0.2	81.2	<0.01	0.07	2.1
ZZ96448		0.38	78.9	1430	32.9	7.5	0.002	0.06	2.01	3.3	2.1	0.3	53.3	<0.01	0.08	2.1
ZZ96449		0.59	56.6	1470	30.3	6.5	0.010	0.08	2.67	3.5	2.8	0.3	77.5	<0.01	0.08	2.4
ZZ96450		0.64	70.5	1470	28.6	6.6	0.006	0.07	2.55	3.4	1.9	0.3	113.5	<0.01	0.07	3.0



ALS Canada Ltd.
 2103 Dollarton Hwy
 North Vancouver BC V7H 0A7
 Phone: 604 984 0221 Fax: 604 984 0218 www.alsglobal.com

To: ATAC RESOURCES LTD.
 C/O ARCHER, CATHRO & ASSOCIATES (1981)
 LIMITED
 1016-510 W HASTINGS ST
 VANCOUVER BC V6B 1L8

Page: 6 - D
 Total # Pages: 8 (A - D)
 Plus Appendix Pages
 Finalized Date: 30-SEP-2014
 Account: RCM

Project: Area G & H

CERTIFICATE OF ANALYSIS WH14146243

Sample Description	Method Analyte Units LOR	ME-MS41	ME-MS41	ME-MS41	ME-MS41	ME-MS41	ME-MS41	ME-MS41	ME-MS41
		Ti %	Ti ppm	U ppm	V ppm	W ppm	Y ppm	Zn ppm	Zr ppm
		0.005	0.02	0.05	1	0.05	0.05	2	0.5
ZZ96411		0.011	0.27	2.34	58	0.08	15.80	243	2.4
ZZ96412		0.010	0.33	3.62	68	0.06	15.20	264	2.9
ZZ96413		0.012	0.26	2.45	62	0.05	14.40	235	2.2
ZZ96414		0.013	0.28	2.45	61	0.05	16.25	224	3.0
ZZ96415		0.009	0.24	2.64	54	0.06	14.75	209	2.5
ZZ96416		0.010	0.22	2.33	51	0.06	15.25	194	2.5
ZZ96417		0.012	0.22	2.48	53	0.05	14.20	229	3.0
ZZ96418		0.014	0.21	2.09	53	0.05	13.55	201	3.1
ZZ96419		0.005	0.17	1.25	21	0.05	8.45	81	1.4
ZZ96420		0.006	0.21	1.74	27	0.07	14.65	92	0.8
ZZ96421		0.010	0.30	2.26	71	0.08	11.50	112	1.4
ZZ96422		0.013	0.29	1.76	75	0.17	15.45	163	1.7
ZZ96423		0.014	0.26	2.20	62	0.12	17.85	245	2.7
ZZ96424		0.016	0.20	1.96	51	0.05	12.25	242	2.3
ZZ96425		0.015	0.31	2.58	70	0.07	16.45	273	2.5
ZZ96426		0.012	0.23	1.86	53	0.07	13.35	248	1.7
ZZ96427		0.005	0.22	2.17	43	0.06	25.3	157	1.3
ZZ96428		0.007	0.18	1.55	54	0.05	13.20	147	2.4
ZZ96429		0.008	0.22	1.51	41	0.06	11.80	128	1.9
ZZ96430		0.008	0.16	0.88	34	0.06	10.20	130	2.2
ZZ96431		0.026	0.20	1.82	59	0.26	8.26	91	1.5
ZZ96432		0.027	0.13	1.04	44	0.24	11.10	89	1.5
ZZ96433		0.011	0.24	1.91	41	0.07	13.10	131	2.4
ZZ96434		0.018	0.28	2.39	59	0.06	14.00	208	3.1
ZZ96435		0.018	0.27	2.28	58	0.07	14.30	239	2.5
ZZ96436		0.018	0.21	1.93	52	0.07	13.15	199	2.2
ZZ96437		0.013	0.21	1.87	51	0.06	12.90	177	3.1
ZZ96438		0.016	0.27	2.14	63	0.07	14.65	225	2.2
ZZ96439		0.022	0.25	2.01	64	0.07	14.05	227	2.8
ZZ96440		0.013	0.33	2.43	71	0.10	15.60	282	2.2
ZZ96441		0.013	0.33	2.67	72	0.08	16.65	282	2.2
ZZ96442		0.008	0.20	1.25	30	0.09	9.71	122	2.0
ZZ96443		0.019	0.14	1.44	49	0.21	12.60	75	0.9
ZZ96444		0.007	0.57	2.67	63	0.11	15.75	231	2.8
ZZ96445		0.013	0.26	2.33	60	0.06	15.45	226	2.3
ZZ96446		0.015	0.32	2.15	62	0.11	16.15	260	2.1
ZZ96447		0.010	0.24	2.02	57	0.06	13.05	204	3.2
ZZ96448		0.009	0.24	2.39	53	0.07	14.80	233	2.0
ZZ96449		0.012	0.31	2.87	58	0.07	15.50	178	2.4
ZZ96450		0.013	0.31	2.56	52	0.09	14.75	182	3.3



ALS Canada Ltd.
 2103 Dollarton Hwy
 North Vancouver BC V7H 0A7
 Phone: 604 984 0221 Fax: 604 984 0218 www.alsglobal.com

To: ATAC RESOURCES LTD.
 C/O ARCHER, CATHRO & ASSOCIATES (1981)
 LIMITED
 1016-510 W HASTINGS ST
 VANCOUVER BC V6B 1L8

Page: 7 - D
 Total # Pages: 8 (A - D)
 Plus Appendix Pages
 Finalized Date: 30-SEP-2014
 Account: RCM

Project: Area G & H

CERTIFICATE OF ANALYSIS WH14146243

Sample Description	Method Analyte Units LOR	ME-MS41	ME-MS41	ME-MS41	ME-MS41	ME-MS41	ME-MS41	ME-MS41	ME-MS41
		Ti %	Ti ppm	U ppm	V ppm	W ppm	Y ppm	Zn ppm	Zr ppm
		0.005	0.02	0.05	1	0.05	0.05	2	0.5
ZZ96451		0.016	0.24	2.07	53	0.06	13.75	277	2.3
ZZ96452		0.010	0.55	2.99	62	0.08	12.90	229	2.1
ZZ96453		0.011	0.32	1.98	53	0.06	12.25	257	2.1
ZZ96454		0.011	0.24	1.52	60	0.13	15.80	185	1.3
ZZ96455		0.010	0.22	2.87	52	0.08	15.10	142	2.7
ZZ96456		0.012	0.66	2.88	94	0.33	14.10	106	2.2
ZZ96457		0.021	0.20	1.40	58	0.21	10.80	101	1.3
ZZ96458		0.010	0.25	1.52	60	0.12	15.65	188	2.2
ZZ96459		0.009	0.14	1.46	32	0.09	12.05	73	1.0
ZZ96460		0.008	0.22	1.23	32	0.08	10.50	117	1.4
ZZ96461		0.010	0.23	2.71	41	0.11	9.15	83	1.2
ZZ96462		0.015	0.20	1.33	44	0.09	11.90	119	1.9
ZZ96463		0.010	0.12	2.32	26	0.09	8.52	153	0.6
ZZ96464		0.010	0.20	1.52	41	0.11	19.00	81	1.4
ZZ96465		0.008	0.49	1.51	47	0.08	12.90	129	2.3
ZZ96466		0.014	0.25	2.61	62	0.11	15.00	229	2.1
ZZ96467		0.020	0.23	2.52	57	0.06	13.55	221	2.7
ZZ96468		0.020	0.25	2.26	57	0.08	13.70	217	2.3
ZZ96469		0.017	0.22	1.81	58	0.08	14.80	223	2.2
ZZ96470		0.018	0.20	2.21	56	0.09	14.40	214	2.3
ZZ96471		0.017	0.29	2.08	60	0.07	14.85	241	2.5
ZZ96472		0.018	0.30	1.99	70	0.08	16.70	276	2.8
ZZ96473		0.015	0.32	2.15	68	0.07	17.95	273	2.4
ZZ96474		0.014	0.15	1.89	42	0.07	11.60	226	2.4
ZZ96475		0.011	0.22	1.93	52	0.05	12.40	267	2.0
ZZ96476		0.013	0.31	2.52	65	0.08	16.15	264	2.3
ZZ96477		0.013	0.29	2.87	67	0.08	17.00	241	3.2
ZZ96478		0.011	0.35	2.93	84	0.08	19.55	348	2.7
ZZ96479		0.014	0.28	2.50	77	0.06	18.05	282	2.7
ZZ96480		0.015	0.21	2.04	59	0.06	13.60	219	3.8
ZZ96481		0.010	0.16	1.13	34	0.08	11.75	101	0.9
ZZ96482		0.007	0.16	1.08	35	0.07	12.65	84	1.2
ZZ96483		0.009	0.21	1.22	47	0.15	18.35	76	1.3
ZZ96484		<0.005	0.37	1.26	29	0.06	15.05	71	1.3
ZZ96485		0.014	0.29	1.22	50	0.08	14.95	179	1.7
ZZ96486		0.010	0.23	1.56	45	0.10	14.25	138	2.2
ZZ96487		0.010	0.28	1.65	45	0.08	15.60	145	2.5
ZZ96488		0.009	0.23	1.66	42	0.07	8.68	123	1.4
ZZ96489		0.009	0.32	1.33	58	0.09	16.95	240	2.9
ZZ96490		0.011	0.32	1.93	64	0.15	16.15	172	2.4



ALS Canada Ltd.
 2103 Dollarton Hwy
 North Vancouver BC V7H 0A7
 Phone: 604 984 0221 Fax: 604 984 0218 www.alsglobal.com

To: ATAC RESOURCES LTD.
 C/O ARCHER, CATHRO & ASSOCIATES (1981)
 LIMITED
 1016-510 W HASTINGS ST
 VANCOUVER BC V6B 1L8

Page: 8 - A
 Total # Pages: 8 (A - D)
 Plus Appendix Pages
 Finalized Date: 30-SEP-2014
 Account: RCM

Project: Area G & H

CERTIFICATE OF ANALYSIS WH14146243

Sample Description	Method Analyte Units LOR	WEI-21 Recvd Wt. kg	Au-ICP21 Au ppm	ME-MS41 Ag ppm	ME-MS41 Al %	ME-MS41 As ppm	ME-MS41 Au ppm	ME-MS41 B ppm	ME-MS41 Ba ppm	ME-MS41 Be ppm	ME-MS41 Bi ppm	ME-MS41 Ca %	ME-MS41 Cd ppm	ME-MS41 Ce ppm	ME-MS41 Co ppm	ME-MS41 Cr ppm
		0.02	0.001	0.01	0.01	0.1	0.2	10	10	0.05	0.01	0.01	0.01	0.02	0.1	1
ZZ96491		0.12	<0.001	0.20	0.90	15.3	<0.2	<10	320	0.60	0.14	6.68	0.75	18.20	7.0	17
ZZ96492		0.20	<0.001	0.22	1.03	14.0	<0.2	<10	520	0.63	0.16	4.93	1.01	19.65	7.2	19
ZZ96493		0.13	<0.001	0.14	0.81	10.1	<0.2	<10	170	0.52	0.11	12.10	0.49	14.55	5.9	13
ZZ96494		0.48	0.005	0.15	0.66	10.2	<0.2	<10	410	0.41	0.11	8.14	0.56	13.60	5.5	14
ZZ96495		0.24	<0.001	0.09	1.68	14.0	<0.2	<10	240	0.79	0.26	0.90	0.43	31.5	10.0	30
ZZ96496		0.20	0.002	0.27	1.45	15.1	<0.2	<10	420	0.75	0.21	1.84	0.24	28.0	8.7	27
ZZ96497		0.13	<0.001	0.05	1.50	16.4	<0.2	<10	230	0.75	0.22	1.75	0.91	25.3	9.0	25
ZZ96498		0.19	0.006	0.08	0.43	7.3	<0.2	<10	180	0.48	0.07	13.30	1.18	10.95	2.6	10
ZZ96499		0.16	0.008	0.18	1.24	15.2	<0.2	<10	400	0.77	0.20	3.98	1.02	25.4	7.8	23
ZZ96500		0.39	0.002	0.24	1.11	12.5	<0.2	<10	310	0.66	0.16	5.66	0.56	21.4	8.0	20

***** See Appendix Page for comments regarding this certificate *****



ALS Canada Ltd.
 2103 Dollarton Hwy
 North Vancouver BC V7H 0A7
 Phone: 604 984 0221 Fax: 604 984 0218 www.alsglobal.com

To: ATAC RESOURCES LTD.
 C/O ARCHER, CATHRO & ASSOCIATES (1981)
 LIMITED
 1016-510 W HASTINGS ST
 VANCOUVER BC V6B 1L8

Page: 8 - B
 Total # Pages: 8 (A - D)
 Plus Appendix Pages
 Finalized Date: 30-SEP-2014
 Account: RCM

Project: Area G & H

CERTIFICATE OF ANALYSIS WH14146243

Sample Description	Method Analyte Units LOR	ME-MS41	ME-MS41	ME-MS41	ME-MS41	ME-MS41	ME-MS41	ME-MS41	ME-MS41	ME-MS41	ME-MS41	ME-MS41	ME-MS41	ME-MS41	ME-MS41	
		Cs ppm	Cu ppm	Fe %	Ga ppm	Ge ppm	Hf ppm	Hg ppm	In ppm	K %	La ppm	Li ppm	Mg %	Mn ppm	Mo ppm	Na %
		0.05	0.2	0.01	0.05	0.05	0.02	0.01	0.005	0.01	0.2	0.1	0.01	5	0.05	0.01
ZZ96491		0.75	21.3	2.00	2.53	0.05	0.02	0.25	0.020	0.07	10.2	10.7	3.74	393	1.13	0.01
ZZ96492		0.57	23.2	1.94	2.80	<0.05	0.02	0.23	0.021	0.06	10.7	10.4	1.95	473	0.84	0.01
ZZ96493		0.69	13.0	1.70	2.06	<0.05	0.03	0.09	0.017	0.07	7.4	9.6	4.59	362	0.98	0.01
ZZ96494		0.53	13.5	1.53	1.86	<0.05	0.03	0.13	0.016	0.05	6.4	7.8	3.92	438	0.88	0.01
ZZ96495		1.14	11.6	2.79	5.09	0.05	0.02	0.15	0.029	0.05	15.9	12.6	0.58	524	0.96	0.01
ZZ96496		0.91	25.0	2.48	4.09	0.05	0.04	0.28	0.026	0.05	15.2	13.9	0.85	314	0.83	0.01
ZZ96497		0.70	14.5	2.62	4.39	0.05	0.03	0.11	0.033	0.05	11.4	12.6	0.64	321	1.60	0.01
ZZ96498		0.34	12.0	0.65	1.07	0.06	0.03	0.14	0.011	0.02	6.0	2.4	6.64	268	0.84	0.02
ZZ96499		0.76	16.8	2.20	3.66	0.05	0.02	0.14	0.025	0.05	12.4	12.3	1.80	430	0.90	0.01
ZZ96500		0.67	23.6	2.31	3.12	0.05	0.04	0.18	0.022	0.08	11.2	14.5	2.87	324	1.22	0.01

***** See Appendix Page for comments regarding this certificate *****



ALS Canada Ltd.
 2103 Dollarton Hwy
 North Vancouver BC V7H 0A7
 Phone: 604 984 0221 Fax: 604 984 0218 www.alsglobal.com

To: ATAC RESOURCES LTD.
 C/O ARCHER, CATHRO & ASSOCIATES (1981)
 LIMITED
 1016-510 W HASTINGS ST
 VANCOUVER BC V6B 1L8

Page: 8 - C
 Total # Pages: 8 (A - D)
 Plus Appendix Pages
 Finalized Date: 30-SEP-2014
 Account: RCM

Project: Area G & H

CERTIFICATE OF ANALYSIS WH14146243

Sample Description	Method Analyte Units LOR	ME-MS41 Nb ppm	ME-MS41 Ni ppm	ME-MS41 P ppm	ME-MS41 Pb ppm	ME-MS41 Rb ppm	ME-MS41 Re ppm	ME-MS41 S %	ME-MS41 Sb ppm	ME-MS41 Sc ppm	ME-MS41 Se ppm	ME-MS41 Sn ppm	ME-MS41 Sr ppm	ME-MS41 Ta ppm	ME-MS41 Te ppm	ME-MS41 Th ppm
		0.05	0.2	10	0.2	0.1	0.001	0.01	0.05	0.1	0.2	0.2	0.2	0.01	0.01	0.2
ZZ96491		0.39	23.3	760	11.8	7.0	0.001	0.05	0.94	2.1	1.1	0.3	59.0	<0.01	0.03	0.6
ZZ96492		0.45	20.2	1040	11.6	5.8	<0.001	0.09	0.80	1.3	1.4	0.3	48.6	<0.01	0.03	0.3
ZZ96493		0.28	17.3	660	11.1	5.5	<0.001	0.02	0.68	2.3	0.6	0.2	128.5	<0.01	0.03	1.0
ZZ96494		0.32	14.2	760	9.0	4.8	0.001	0.06	0.53	1.4	1.0	0.2	65.1	<0.01	0.02	0.5
ZZ96495		0.94	18.4	440	16.5	8.6	<0.001	0.03	0.58	2.8	0.6	0.5	16.7	<0.01	0.04	1.7
ZZ96496		0.78	25.1	650	13.4	6.7	<0.001	0.04	0.69	2.9	1.0	0.4	24.2	<0.01	0.03	1.2
ZZ96497		0.76	21.0	570	19.2	6.7	<0.001	0.05	1.06	2.7	0.7	0.5	22.0	<0.01	0.04	1.1
ZZ96498		0.14	9.4	990	5.1	3.1	0.001	0.09	0.53	0.5	0.9	<0.2	91.4	<0.01	0.01	0.2
ZZ96499		0.70	20.1	870	11.9	7.6	<0.001	0.07	0.77	1.7	1.1	0.4	34.7	<0.01	0.03	0.6
ZZ96500		0.43	24.5	800	14.7	6.7	<0.001	0.03	0.77	3.1	0.9	0.3	55.8	<0.01	0.04	1.3

***** See Appendix Page for comments regarding this certificate *****



ALS Canada Ltd.
 2103 Dollarton Hwy
 North Vancouver BC V7H 0A7
 Phone: 604 984 0221 Fax: 604 984 0218 www.alsglobal.com

To: ATAC RESOURCES LTD.
 C/O ARCHER, CATHRO & ASSOCIATES (1981)
 LIMITED
 1016-510 W HASTINGS ST
 VANCOUVER BC V6B 1L8

Page: 8 - D
 Total # Pages: 8 (A - D)
 Plus Appendix Pages
 Finalized Date: 30-SEP-2014
 Account: RCM

Project: Area G & H

CERTIFICATE OF ANALYSIS WH14146243

Sample Description	Method Analyte Units LOR	ME-MS41	ME-MS41	ME-MS41	ME-MS41	ME-MS41	ME-MS41	ME-MS41	ME-MS41
		Ti %	Ti ppm	U ppm	V ppm	W ppm	Y ppm	Zn ppm	Zr ppm
		0.005	0.02	0.05	1	0.05	0.05	2	0.5
ZZ96491		0.011	0.48	1.52	35	0.07	11.60	112	1.0
ZZ96492		0.012	0.23	2.14	36	0.10	11.10	114	0.8
ZZ96493		0.008	0.25	1.43	27	<0.05	8.24	80	1.2
ZZ96494		0.009	0.18	2.01	24	0.09	7.36	79	1.1
ZZ96495		0.031	0.16	1.87	61	0.22	8.49	69	0.7
ZZ96496		0.021	0.31	2.63	52	0.23	13.60	86	1.1
ZZ96497		0.016	0.18	2.01	57	0.17	7.22	108	1.1
ZZ96498		0.005	0.16	6.01	17	<0.05	6.68	47	0.9
ZZ96499		0.020	0.33	2.57	45	0.18	8.90	111	0.8
ZZ96500		0.012	0.21	1.10	37	0.08	11.85	100	1.3

***** See Appendix Page for comments regarding this certificate *****



ALS Canada Ltd.
 2103 Dollarton Hwy
 North Vancouver BC V7H 0A7
 Phone: 604 984 0221 Fax: 604 984 0218 www.alsglobal.com

To: ATAC RESOURCES LTD.
 C/O ARCHER, CATHRO & ASSOCIATES (1981)
 LIMITED
 1016-510 W HASTINGS ST
 VANCOUVER BC V6B 1L8

Page: 1
 Total # Pages: 4 (A - D)
 Plus Appendix Pages
 Finalized Date: 30-SEP-2014
 Account: RCM

CERTIFICATE WH14146245

Project: Area G & H

This report is for 85 Soil samples submitted to our lab in Whitehorse, YT, Canada on 16-SEP-2014.

The following have access to data associated with this certificate:

ROB CARNE	JULIA LANE	JOAN MARIACHER
-----------	------------	----------------

SAMPLE PREPARATION	
ALS CODE	DESCRIPTION
WEI-21	Received Sample Weight
LOG-22	Sample login - Rcd w/o BarCode
SCR-41	Screen to -180um and save both

ANALYTICAL PROCEDURES		
ALS CODE	DESCRIPTION	INSTRUMENT
Au-ICP21	Au 30g FA ICP-AES Finish	ICP-AES
ME-MS41	51 anal. aqua regia ICPMS	

To: ATAC RESOURCES LTD.
 ATTN: JULIA LANE
 C/O ARCHER, CATHRO & ASSOCIATES (1981) LIMITED
 1016-510 W HASTINGS ST
 VANCOUVER BC V6B 1L8

This is the Final Report and supersedes any preliminary report with this certificate number. Results apply to samples as submitted. All pages of this report have been checked and approved for release.

***** See Appendix Page for comments regarding this certificate *****

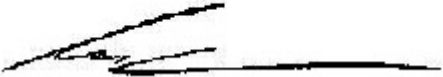
Signature: 
 Colin Ramshaw, Vancouver Laboratory Manager



ALS Canada Ltd.
 2103 Dollarton Hwy
 North Vancouver BC V7H 0A7
 Phone: 604 984 0221 Fax: 604 984 0218 www.alsglobal.com

To: ATAC RESOURCES LTD.
 C/O ARCHER, CATHRO & ASSOCIATES (1981)
 LIMITED
 1016-510 W HASTINGS ST
 VANCOUVER BC V6B 1L8

Page: 2 - D
 Total # Pages: 4 (A - D)
 Plus Appendix Pages
 Finalized Date: 30-SEP-2014
 Account: RCM

Project: Area G & H

CERTIFICATE OF ANALYSIS WH14146245

Sample Description	Method	ME-MS41	ME-MS41	ME-MS41	ME-MS41	ME-MS41	ME-MS41	ME-MS41	ME-MS41
	Analyte	Ti	Ti	U	V	W	Y	Zn	Zr
Units		%	ppm	ppm	ppm	ppm	ppm	ppm	ppm
LOR		0.005	0.02	0.05	1	0.05	0.05	2	0.5
ZZ94430		<0.005	0.20	1.67	21	0.05	8.58	115	1.8
ZZ94431		<0.005	0.20	2.24	24	0.06	9.21	123	1.5
ZZ94432		0.006	0.36	1.89	45	<0.05	11.60	144	1.4
ZZ94433		<0.005	0.17	2.66	20	0.06	7.66	106	1.8
ZZ94434		<0.005	0.24	5.14	16	<0.05	9.30	103	1.6
ZZ94435		<0.005	0.19	3.51	16	<0.05	7.89	85	1.5
ZZ94436		0.011	0.28	1.68	58	0.06	16.15	253	2.2
ZZ94437		0.014	0.27	1.87	63	0.07	16.95	267	2.7
ZZ94438		0.014	0.23	1.83	56	0.10	14.80	240	2.6
ZZ94439		0.015	0.24	2.06	61	0.07	16.25	257	2.4
ZZ94440		0.012	0.23	2.01	60	0.09	14.30	251	2.1
ZZ94441		0.013	0.29	1.43	60	0.16	11.80	128	1.2
ZZ94442		0.006	0.53	1.73	111	0.19	23.6	173	1.8
ZZ94443		0.024	0.14	1.07	48	0.19	12.20	85	0.9
ZZ94444		0.011	0.34	1.71	43	0.10	14.35	139	1.3
ZZ94445		0.006	0.97	1.76	90	0.11	18.65	175	1.5
ZZ94446		0.018	0.21	2.03	47	0.20	13.55	120	1.0
ZZ94447		0.012	0.34	1.37	55	0.13	14.35	120	2.3
ZZ94448		0.010	0.29	1.70	35	0.09	11.20	97	1.8
ZZ94449		0.013	0.24	1.49	50	0.15	17.90	109	1.8
ZZ94450		0.010	0.25	1.82	57	0.09	13.65	158	1.4
ZZ94451		0.010	0.22	1.46	50	0.11	17.00	109	2.4
ZZ94452		0.008	0.34	3.08	42	0.10	12.15	120	1.5
ZZ94453		0.014	0.39	1.44	62	0.15	16.65	139	1.4
ZZ94454		0.009	0.37	2.02	67	0.08	18.05	193	2.2
ZZ94455		0.010	0.23	2.18	50	0.11	14.60	161	2.2
ZZ94456		0.014	0.25	1.66	48	0.14	15.65	116	1.8
ZZ94457		0.011	0.45	1.49	59	0.11	19.35	132	1.6
ZZ94458		0.010	0.24	1.65	53	0.10	16.85	130	2.4
ZZ94459		0.009	0.21	1.91	45	0.07	12.30	104	1.0
ZZ94460		0.013	0.22	2.18	45	0.14	14.80	125	1.7
ZZ94461		0.014	0.25	2.33	58	0.09	15.15	238	3.0
ZZ94462		0.011	0.27	2.36	49	0.08	13.90	179	3.2
ZZ94463		0.011	0.25	2.35	73	0.09	15.55	264	2.7
ZZ94464		0.015	0.23	2.06	59	0.05	13.95	226	2.2
ZZ94465		0.011	0.30	1.85	57	0.05	13.40	268	2.2
ZZ94466		0.010	0.16	3.97	38	0.05	11.75	155	2.8
ZZ94467		0.018	0.19	1.82	50	<0.05	13.25	183	3.0
ZZ94468		0.017	0.27	2.33	70	0.07	16.60	301	2.6
ZZ94469		0.014	0.29	2.86	73	0.06	17.10	277	2.3



ALS Canada Ltd.
 2103 Dollarton Hwy
 North Vancouver BC V7H 0A7
 Phone: 604 984 0221 Fax: 604 984 0218 www.alsglobal.com

To: ATAC RESOURCES LTD.
 C/O ARCHER, CATHRO & ASSOCIATES (1981)
 LIMITED
 1016-510 W HASTINGS ST
 VANCOUVER BC V6B 1L8

Page: 3 - D
 Total # Pages: 4 (A - D)
 Plus Appendix Pages
 Finalized Date: 30-SEP-2014
 Account: RCM

Project: Area G & H

CERTIFICATE OF ANALYSIS WH14146245

Sample Description	Method Analyte Units LOR	ME-MS41	ME-MS41	ME-MS41	ME-MS41	ME-MS41	ME-MS41	ME-MS41	ME-MS41
		Ti %	Ti ppm	U ppm	V ppm	W ppm	Y ppm	Zn ppm	Zr ppm
		0.005	0.02	0.05	1	0.05	0.05	2	0.5
ZZ94470		0.010	0.16	1.00	33	0.07	11.10	123	1.7
ZZ94471		0.009	0.15	0.98	31	0.07	11.80	123	1.9
ZZ94472		0.010	0.14	1.17	28	0.09	9.85	122	1.5
ZZ94473		0.010	0.15	1.01	32	0.07	11.20	125	1.9
ZZ94474		0.007	0.09	1.25	21	<0.05	7.77	98	1.7
ZZ94475		0.009	0.16	1.03	33	0.09	11.60	137	1.7
ZZ94476		0.008	0.13	1.29	26	0.05	9.86	130	1.9
ZZ94477		0.008	0.17	1.28	25	0.05	9.05	109	1.6
ZZ94478		0.009	0.15	1.12	28	0.05	9.62	98	1.6
ZZ94479		0.009	0.15	1.17	26	0.05	8.63	104	1.6
ZZ94480		0.009	0.18	1.15	38	0.06	12.25	122	1.4
ZZ94481		0.007	0.16	0.95	30	0.05	10.80	100	1.9
ZZ94482		0.008	0.19	1.17	22	<0.05	7.70	80	2.2
ZZ94483		0.007	0.16	1.15	23	0.05	8.52	96	1.6
ZZ94484		0.006	0.18	1.21	25	<0.05	8.47	90	1.6
ZZ94485		0.009	0.16	1.13	25	0.05	9.13	93	1.5
ZZ94486		0.007	0.16	1.80	33	0.05	13.45	108	2.5
ZZ94487		0.009	0.13	0.95	30	0.07	10.85	109	1.5
ZZ94488		0.010	0.18	1.23	30	0.10	10.00	100	1.2
ZZ94489		0.008	0.17	1.51	27	0.06	8.28	79	1.1
ZZ94490		0.022	0.13	1.03	47	0.19	10.60	115	0.9
ZZ94491		0.009	0.27	1.94	64	0.12	15.80	155	2.0
ZZ94492		0.008	0.18	1.65	48	0.08	14.90	128	2.7
ZZ94493		0.007	0.14	1.01	28	0.11	12.55	139	1.2
ZZ94494		0.013	0.31	1.22	48	0.10	14.75	153	2.0
ZZ94495		0.010	0.25	1.06	57	0.11	15.60	150	2.1
ZZ94496		0.022	0.27	1.07	63	0.21	10.05	88	1.0
ZZ94497		0.008	0.16	1.23	37	0.06	12.65	116	1.8
ZZ94498		0.017	0.27	2.15	51	0.11	12.65	134	1.6
ZZ94499		<0.005	0.13	1.47	33	<0.05	13.85	100	0.9
ZZ94500		0.016	0.17	1.04	56	0.16	12.00	87	1.0
ZZ96221		0.011	0.18	1.34	31	0.07	10.10	83	1.1
ZZ96222		0.017	0.21	1.22	38	0.12	11.35	99	1.3
ZZ96223		0.007	0.27	1.40	35	0.05	13.40	84	2.0
ZZ96224		0.010	0.21	1.42	26	0.05	9.06	87	1.2
ZZ96225		0.009	0.29	1.17	49	0.07	9.81	119	1.7
ZZ96226		0.019	0.15	1.20	46	0.15	14.45	98	1.5
ZZ96227		0.012	0.13	1.28	33	0.09	10.35	100	2.4
ZZ96228		0.010	0.16	1.58	34	0.06	11.20	111	2.2
ZZ96229		0.010	0.13	1.07	33	0.07	11.25	111	2.1



ALS Canada Ltd.
 2103 Dollarton Hwy
 North Vancouver BC V7H 0A7
 Phone: 604 984 0221 Fax: 604 984 0218 www.alsglobal.com

To: ATAC RESOURCES LTD.
 C/O ARCHER, CATHRO & ASSOCIATES (1981)
 LIMITED
 1016-510 W HASTINGS ST
 VANCOUVER BC V6B 1L8

Page: 4 - A
 Total # Pages: 4 (A - D)
 Plus Appendix Pages
 Finalized Date: 30-SEP-2014
 Account: RCM

Project: Area G & H

CERTIFICATE OF ANALYSIS WH14146245

Sample Description	Method Analyte Units LOR	WEI-21 Recvd Wt. kg	Au-ICP21 Au ppm	ME-MS41 Ag ppm	ME-MS41 Al %	ME-MS41 As ppm	ME-MS41 Au ppm	ME-MS41 B ppm	ME-MS41 Ba ppm	ME-MS41 Be ppm	ME-MS41 Bi ppm	ME-MS41 Ca %	ME-MS41 Cd ppm	ME-MS41 Ce ppm	ME-MS41 Co ppm	ME-MS41 Cr ppm
		0.02	0.001	0.01	0.01	0.1	0.2	10	10	0.05	0.01	0.01	0.01	0.02	0.1	1
ZZ96230		0.33	0.002	0.18	0.91	7.1	<0.2	10	400	0.58	0.13	7.00	0.64	16.80	6.3	17
ZZ96231		0.17	0.002	0.13	0.87	11.9	<0.2	<10	360	0.52	0.14	7.28	0.90	15.75	6.0	17
ZZ96232		0.39	0.001	0.14	1.05	10.6	<0.2	<10	190	0.57	0.16	8.34	0.46	18.45	7.5	19
ZZ96233		0.26	0.002	0.17	1.02	12.0	<0.2	<10	200	0.53	0.16	5.82	0.49	20.6	6.1	19
ZZ96234		0.33	0.002	0.17	1.39	12.3	<0.2	<10	410	0.60	0.23	2.46	0.32	24.9	8.3	25

***** See Appendix Page for comments regarding this certificate *****



ALS Canada Ltd.
 2103 Dollarton Hwy
 North Vancouver BC V7H 0A7
 Phone: 604 984 0221 Fax: 604 984 0218 www.alsglobal.com

To: ATAC RESOURCES LTD.
 C/O ARCHER, CATHRO & ASSOCIATES (1981)
 LIMITED
 1016-510 W HASTINGS ST
 VANCOUVER BC V6B 1L8

Page: 4 - B
 Total # Pages: 4 (A - D)
 Plus Appendix Pages
 Finalized Date: 30-SEP-2014
 Account: RCM

Project: Area G & H

CERTIFICATE OF ANALYSIS WH14146245

Sample Description	Method Analyte Units LOR	ME-MS41 Cs ppm 0.05	ME-MS41 Cu ppm 0.2	ME-MS41 Fe % 0.01	ME-MS41 Ga ppm 0.05	ME-MS41 Ge ppm 0.05	ME-MS41 Hf ppm 0.02	ME-MS41 Hg ppm 0.01	ME-MS41 In ppm 0.005	ME-MS41 K % 0.01	ME-MS41 La ppm 0.2	ME-MS41 Li ppm 0.1	ME-MS41 Mg % 0.01	ME-MS41 Mn ppm 5	ME-MS41 Mo ppm 0.05	ME-MS41 Na % 0.01
ZZ96230		0.52	20.5	1.58	2.73	<0.05	0.06	0.12	0.018	0.08	8.5	13.7	3.20	169	0.35	0.01
ZZ96231		0.53	16.0	1.79	2.59	<0.05	0.03	0.21	0.018	0.04	8.5	12.4	3.50	447	1.12	0.01
ZZ96232		0.65	17.0	2.27	3.09	<0.05	0.04	0.10	0.022	0.07	9.6	13.2	2.50	421	0.98	0.01
ZZ96233		0.67	11.1	2.17	3.16	<0.05	0.04	0.10	0.025	0.05	10.6	12.4	2.96	252	1.03	0.01
ZZ96234		0.71	12.4	2.51	4.54	<0.05	0.03	0.17	0.026	0.05	12.6	13.4	1.08	464	0.76	0.01

***** See Appendix Page for comments regarding this certificate *****



ALS Canada Ltd.
 2103 Dollarton Hwy
 North Vancouver BC V7H 0A7
 Phone: 604 984 0221 Fax: 604 984 0218 www.alsglobal.com

To: ATAC RESOURCES LTD.
 C/O ARCHER, CATHRO & ASSOCIATES (1981)
 LIMITED
 1016-510 W HASTINGS ST
 VANCOUVER BC V6B 1L8

Page: 4 - C
 Total # Pages: 4 (A - D)
 Plus Appendix Pages
 Finalized Date: 30-SEP-2014
 Account: RCM

Project: Area G & H

CERTIFICATE OF ANALYSIS WH14146245

Sample Description	Method Analyte Units LOR	ME-MS41 Nb ppm 0.05	ME-MS41 Ni ppm 0.2	ME-MS41 P ppm 10	ME-MS41 Pb ppm 0.2	ME-MS41 Rb ppm 0.1	ME-MS41 Re ppm 0.001	ME-MS41 S % 0.01	ME-MS41 Sb ppm 0.05	ME-MS41 Sc ppm 0.1	ME-MS41 Se ppm 0.2	ME-MS41 Sn ppm 0.2	ME-MS41 Sr ppm 0.2	ME-MS41 Ta ppm 0.01	ME-MS41 Te ppm 0.01	ME-MS41 Th ppm 0.2
ZZ96230		0.43	21.1	690	12.8	5.5	0.002	0.10	0.67	3.4	1.7	0.3	76.6	<0.01	0.02	2.0
ZZ96231		0.44	18.1	690	12.0	6.5	0.001	0.08	0.85	1.9	1.1	0.2	64.8	<0.01	0.01	0.4
ZZ96232		0.44	21.0	580	14.0	6.0	<0.001	0.04	0.58	3.2	0.8	0.3	114.0	<0.01	0.02	1.4
ZZ96233		0.55	19.3	640	13.7	5.6	0.001	0.06	0.68	2.9	0.7	0.3	57.0	<0.01	0.02	1.3
ZZ96234		0.77	19.0	730	15.3	6.5	<0.001	0.06	0.52	2.7	0.9	0.4	30.3	<0.01	0.03	1.3

***** See Appendix Page for comments regarding this certificate *****



ALS Canada Ltd.
 2103 Dollarton Hwy
 North Vancouver BC V7H 0A7
 Phone: 604 984 0221 Fax: 604 984 0218 www.alsglobal.com

To: ATAC RESOURCES LTD.
 C/O ARCHER, CATHRO & ASSOCIATES (1981)
 LIMITED
 1016-510 W HASTINGS ST
 VANCOUVER BC V6B 1L8

Page: 4 - D
 Total # Pages: 4 (A - D)
 Plus Appendix Pages
 Finalized Date: 30-SEP-2014
 Account: RCM

Project: Area G & H

CERTIFICATE OF ANALYSIS WH14146245

Sample Description	Method Analyte Units LOR	ME-MS41 Ti %	ME-MS41 TI ppm	ME-MS41 U ppm	ME-MS41 V ppm	ME-MS41 W ppm	ME-MS41 Y ppm	ME-MS41 Zn ppm	ME-MS41 Zr ppm
		0.005	0.02	0.05	1	0.05	0.05	2	0.5
ZZ96230		0.010	0.12	1.26	31	0.07	9.99	102	2.5
ZZ96231		0.012	0.15	1.84	31	0.12	9.79	119	0.9
ZZ96232		0.013	0.15	1.26	34	0.08	9.58	92	1.2
ZZ96233		0.015	0.15	1.30	36	0.16	9.56	82	1.2
ZZ96234		0.021	0.12	1.41	48	0.14	8.54	75	1.1

***** See Appendix Page for comments regarding this certificate *****



ALS Canada Ltd.
2103 Dollarton Hwy
North Vancouver BC V7H 0A7
Phone: 604 984 0221 Fax: 604 984 0218 www.alsglobal.com

To: ATAC RESOURCES LTD.
C/O ARCHER, CATHRO & ASSOCIATES (1981)
LIMITED
1016-510 W HASTINGS ST
VANCOUVER BC V6B 1L8

Page: Appendix 1
Total # Appendix Pages: 1
Finalized Date: 30-SEP-2014
Account: RCM

Project: Area G & H

CERTIFICATE OF ANALYSIS WH14146245

	CERTIFICATE COMMENTS
	<p style="text-align: center;">ANALYTICAL COMMENTS</p> <p>Applies to Method: Gold determinations by this method are semi-quantitative due to the small sample weight used (0.5g). ME-MS41</p> <p style="text-align: center;">LABORATORY ADDRESSES</p> <p>Applies to Method: Processed at ALS Whitehorse located at 78 Mt. Sima Rd, Whitehorse, YT, Canada. LOG-22 SCR-41 WEI-21</p> <p>Applies to Method: Processed at ALS Vancouver located at 2103 Dollarton Hwy, North Vancouver, BC, Canada. Au-ICP21 ME-MS41</p>



ALS Canada Ltd.
 2103 Dollarton Hwy
 North Vancouver BC V7H 0A7
 Phone: 604 984 0221 Fax: 604 984 0218 www.alsglobal.com

To: ATAC RESOURCES LTD.
 C/O ARCHER, CATHRO & ASSOCIATES (1981)
 LIMITED
 1016-510 W HASTINGS ST
 VANCOUVER BC V6B 1L8

Page: 1
 Total # Pages: 2 (A - D)
 Plus Appendix Pages
 Finalized Date: 19-AUG-2014
 Account: RCM

CERTIFICATE WH14120283

Project: RAV
 P.O. No.: BATCH R14-015
 This report is for 23 Rock samples submitted to our lab in Whitehorse, YT, Canada on 8-AUG-2014.
 The following have access to data associated with this certificate:

ROB CARNE	JULIA LANE	JOAN MARIACHER
JORDAN MCDIVITT		

SAMPLE PREPARATION	
ALS CODE	DESCRIPTION
WEI-21	Received Sample Weight
LOG-21	Sample logging - ClientBarCode
CRU-31	Fine crushing - 70% <2mm
SPL-21	Split sample - riffle splitter
PUL-31	Pulverize split to 85% <75 um
CRU-QC	Crushing QC Test
PUL-QC	Pulverizing QC Test

ANALYTICAL PROCEDURES		
ALS CODE	DESCRIPTION	INSTRUMENT
Au-AA26	Ore Grade Au 50g FA AA finish	AAS
ME-XRF10	Fusion XRF - Ore Grade	XRF
OA-GRA06	LOI for ME-XRF06	WST-SIM
Ba-XRF10	Fusion XRF - Ba Ore Grade	XRF
ME-MS61	48 element four acid ICP-MS	
Hg-CV41	Trace Hg - cold vapor/AAS	FIMS

To: ATAC RESOURCES LTD.
 ATTN: JULIA LANE
 C/O ARCHER, CATHRO & ASSOCIATES (1981) LIMITED
 1016-510 W HASTINGS ST
 VANCOUVER BC V6B 1L8

This is the Final Report and supersedes any preliminary report with this certificate number. Results apply to samples as submitted. All pages of this report have been checked and approved for release.

***** See Appendix Page for comments regarding this certificate *****

Signature: 
 Colin Ramshaw, Vancouver Laboratory Manager



ALS Canada Ltd.
 2103 Dollarton Hwy
 North Vancouver BC V7H 0A7
 Phone: 604 984 0221 Fax: 604 984 0218 www.alsglobal.com

To: ATAC RESOURCES LTD.
 C/O ARCHER, CATHRO & ASSOCIATES (1981)
 LIMITED
 1016-510 W HASTINGS ST
 VANCOUVER BC V6B 1L8

Page: 2 - A
 Total # Pages: 2 (A - D)
 Plus Appendix Pages
 Finalized Date: 19-AUG-2014
 Account: RCM

Project: RAV

CERTIFICATE OF ANALYSIS WH14120283

Sample Description	Method Analyte Units LOR	WEI-21 Recvd Wt. kg	Au-AA26 Au ppm	ME-MS61 Ag ppm	ME-MS61 Al %	ME-MS61 As ppm	ME-MS61 Ba ppm	ME-MS61 Be ppm	ME-MS61 Bi ppm	ME-MS61 Ca %	ME-MS61 Cd ppm	ME-MS61 Ce ppm	ME-MS61 Co ppm	ME-MS61 Cr ppm	ME-MS61 Cs ppm	ME-MS61 Cu ppm
		0.02	0.01	0.01	0.01	0.2	10	0.05	0.01	0.01	0.02	0.01	0.1	1	0.05	0.2
Q011154		0.55	0.18	1.03	10.65	46.6	8140	5.10	6.25	0.14	0.64	99.3	7.0	45	1.93	21.7
Q011155		0.16	0.91	3.64	11.35	221	7650	5.68	25.6	0.29	4.32	182.5	15.8	56	2.33	36.0
Q011156		0.52	1.86	11.85	0.21	1985	90	0.14	1285	19.05	5.13	32.4	10.0	9	0.08	16.4
Q011157		0.21	0.09	0.97	3.82	27.8	2480	1.08	3.08	22.0	0.37	52.8	4.9	20	0.77	12.9
Q011158		0.76	0.04	5.13	4.22	87.0	>10000	0.75	7.66	12.95	2.82	61.2	17.0	136	1.43	60.0
Q013951		0.68	0.09	1.28	0.05	212	80	0.15	8.58	24.3	1.67	2.66	1.4	2	0.10	3.2
Q013952		0.12	0.39	8.73	0.04	1180	40	0.18	66.8	18.05	9.75	40.0	10.3	9	<0.05	7.4
Q013953		0.32	4.21	9.42	0.20	3950	80	<0.05	3850	13.75	1.98	2.57	3.4	6	0.05	48.8
Q011239		0.27	0.15	0.83	8.69	60.9	6790	3.82	27.4	11.40	0.39	90.6	4.0	36	1.98	11.5
Q011240		0.47	0.07	1.92	0.11	112.0	80	0.14	9.29	31.3	2.50	3.13	1.0	4	0.12	2.3
Q011241		1.05	0.06	0.76	0.48	60.1	320	0.27	30.6	19.70	0.96	10.75	2.2	9	0.37	8.3
Q011242		0.33	0.14	0.76	10.75	34.8	>10000	5.48	31.4	0.27	0.20	188.5	4.2	33	2.18	5.1
Q011243		0.54	0.01	0.14	0.05	3.3	40	0.12	2.55	21.3	0.35	1.46	0.3	1	<0.05	<0.2
Q011244		0.99	0.22	2.50	1.13	260	700	0.54	259	17.05	5.06	41.5	9.3	36	1.43	105.5
Q011245		0.41	0.03	0.48	0.13	17.2	70	0.13	3.64	27.6	0.69	3.11	0.5	6	0.10	1.3
Q011246		0.58	0.47	20.1	0.06	452	90	0.12	9.83	30.6	14.50	3.42	1.3	10	0.07	12.4
Q011247		0.18	0.54	5.69	0.02	242	50	0.14	31.1	32.6	5.17	2.00	0.7	10	<0.05	3.1
Q011248		0.31	0.02	0.29	0.13	9.6	80	0.18	4.34	20.5	0.35	3.92	0.4	5	0.06	3.1
Q011249		0.50	0.01	0.12	0.02	2.7	20	0.21	0.87	21.2	0.17	1.38	0.3	1	0.07	1.2
Q011250		0.36	0.07	1.32	0.92	48.2	60	0.35	4.82	28.7	1.85	68.4	1.5	44	<0.05	5.9
Q011251		0.39	0.10	1.15	1.23	82.0	780	0.83	108.0	18.75	1.20	19.60	2.5	17	1.22	25.2
Q011252		0.58	0.01	0.14	0.26	5.0	170	0.46	1.03	21.0	0.41	4.32	0.3	3	0.24	1.6
Q011253		0.21	0.02	0.43	6.20	226	7700	1.13	1.11	0.52	2.65	126.0	149.0	224	2.16	261



ALS Canada Ltd.
 2103 Dollarton Hwy
 North Vancouver BC V7H 0A7
 Phone: 604 984 0221 Fax: 604 984 0218 www.alsglobal.com

To: ATAC RESOURCES LTD.
 C/O ARCHER, CATHRO & ASSOCIATES (1981)
 LIMITED
 1016-510 W HASTINGS ST
 VANCOUVER BC V6B 1L8

Page: 2 - B
 Total # Pages: 2 (A - D)
 Plus Appendix Pages
 Finalized Date: 19-AUG-2014
 Account: RCM

Project: RAV

CERTIFICATE OF ANALYSIS WH14120283

Sample Description	Method Analyte Units LOR	ME-MS61	ME-MS61	ME-MS61	ME-MS61	Hg-CV41	ME-MS61	ME-MS61	ME-MS61	ME-MS61	ME-MS61	ME-MS61	ME-MS61	ME-MS61	ME-MS61	
		Fe %	Ga ppm	Ge ppm	Hf ppm	Hg ppm	In ppm	K %	La ppm	Li ppm	Mg %	Mn ppm	Mo ppm	Na %	Nb ppm	Ni ppm
Q011154		4.05	35.6	0.17	14.1	0.03	0.037	6.10	48.8	24.5	0.62	72	1.84	0.10	136.0	23.4
Q011155		12.50	33.0	0.26	10.3	0.23	0.051	5.43	95.8	25.8	0.77	260	3.91	0.09	43.0	55.9
Q011156		22.8	1.50	0.08	0.3	0.09	0.023	0.06	17.9	1.0	0.29	437	2.01	0.01	0.8	49.5
Q011157		3.01	10.15	0.14	3.5	0.02	0.016	1.83	27.8	7.1	2.98	146	1.01	0.03	37.1	17.7
Q011158		3.02	8.95	0.18	3.6	0.35	0.216	1.75	34.2	8.9	7.99	293	3.06	0.06	19.2	84.4
Q013951		8.00	0.19	0.06	<0.1	0.03	0.012	0.02	1.5	1.2	6.11	439	0.95	0.01	0.1	10.6
Q013952		27.8	0.52	0.08	<0.1	0.06	0.031	0.01	23.7	0.5	0.24	596	1.83	<0.01	0.1	79.0
Q013953		27.3	1.30	0.08	0.4	0.08	0.012	0.03	1.5	0.8	0.25	547	2.14	0.02	0.5	21.7
Q011239		3.07	21.0	0.18	8.6	0.03	0.015	4.33	49.5	21.2	3.14	274	2.66	0.08	68.2	19.8
Q011240		2.32	0.37	<0.05	0.1	0.03	0.010	0.04	1.9	1.0	3.49	281	0.28	<0.01	0.5	6.6
Q011241		1.54	1.54	<0.05	0.4	0.02	0.031	0.19	5.9	3.6	11.30	452	0.55	0.02	3.2	10.5
Q011242		1.52	41.9	0.24	13.1	0.03	0.021	6.52	96.2	46.1	0.80	25	0.90	0.13	190.0	12.9
Q011243		0.11	0.23	0.51	<0.1	<0.01	<0.005	0.02	0.8	3.1	13.45	178	0.05	0.01	0.4	0.6
Q011244		5.71	3.60	0.09	0.5	0.10	0.163	0.41	24.7	6.7	8.03	1260	1.74	0.03	4.9	46.0
Q011245		0.48	0.79	0.17	0.1	0.02	0.007	0.03	1.6	2.1	7.76	216	0.10	0.01	0.9	3.9
Q011246		7.45	0.34	0.06	<0.1	0.23	0.054	0.02	1.9	0.5	1.62	310	0.85	<0.01	0.2	19.8
Q011247		4.10	0.10	<0.05	<0.1	0.07	0.013	<0.01	1.0	0.4	1.90	205	0.33	<0.01	<0.1	6.6
Q011248		0.20	0.48	0.20	0.1	0.01	0.006	0.05	2.3	1.7	12.90	204	0.11	0.02	0.4	1.7
Q011249		0.09	0.15	0.42	<0.1	<0.01	<0.005	0.01	0.7	1.6	13.45	188	<0.05	0.01	<0.1	0.7
Q011250		1.21	6.47	0.21	0.5	0.07	<0.005	0.02	30.3	1.4	4.03	297	0.73	0.10	2.2	16.5
Q011251		1.59	3.39	0.13	0.7	0.05	0.040	0.56	11.3	4.7	11.40	396	4.03	0.04	3.5	14.4
Q011252		0.16	0.90	0.36	0.2	0.01	<0.005	0.13	2.7	1.8	12.55	132	0.27	0.01	0.8	2.1
Q011253		25.2	17.65	0.23	4.5	0.14	0.086	3.01	66.6	15.6	0.69	304	15.95	0.08	10.4	631

***** See Appendix Page for comments regarding this certificate *****



ALS Canada Ltd.
 2103 Dollarton Hwy
 North Vancouver BC V7H 0A7
 Phone: 604 984 0221 Fax: 604 984 0218 www.alsglobal.com

To: ATAC RESOURCES LTD.
 C/O ARCHER, CATHRO & ASSOCIATES (1981)
 LIMITED
 1016-510 W HASTINGS ST
 VANCOUVER BC V6B 1L8

Page: 2 - C
 Total # Pages: 2 (A - D)
 Plus Appendix Pages
 Finalized Date: 19-AUG-2014
 Account: RCM

Project: RAV

CERTIFICATE OF ANALYSIS WH14120283

Sample Description	Method Analyte Units LOR	ME-MS61	ME-MS61	ME-MS61	ME-MS61	ME-MS61	ME-MS61	ME-MS61	ME-MS61	ME-MS61	ME-MS61	ME-MS61	ME-MS61	ME-MS61	ME-MS61	
		P	Pb	Rb	Re	S	Sb	Sc	Se	Sn	Sr	Ta	Te	Th	Ti	Tl
		ppm	ppm	ppm	ppm	%	ppm	ppm	ppm	ppm	ppm	ppm	ppm	ppm	%	ppm
		10	0.5	0.1	0.002	0.01	0.05	0.1	1	0.2	0.2	0.05	0.05	0.2	0.005	0.02
Q011154		520	40.9	119.5	<0.002	0.04	4.28	6.4	2	8.6	10.8	8.92	0.05	21.3	0.503	2.62
Q011155		1510	197.5	138.5	<0.002	0.03	11.00	8.0	4	7.3	11.8	2.60	<0.05	31.2	0.206	2.08
Q011156		980	1010	2.0	<0.002	0.05	51.6	0.4	3	0.7	6.4	0.05	0.58	0.8	0.011	0.18
Q011157		550	25.1	54.0	<0.002	<0.01	3.69	3.7	1	1.6	21.9	1.98	<0.05	7.3	0.198	0.70
Q011158		2660	639	37.4	<0.002	0.01	13.15	13.9	2	1.2	57.7	1.21	0.06	3.8	0.552	1.14
Q013951		160	47.6	0.7	<0.002	<0.01	1.06	0.3	1	<0.2	25.6	<0.05	<0.05	<0.2	<0.005	0.09
Q013952		720	151.0	0.2	<0.002	0.05	8.98	0.6	3	0.2	4.3	<0.05	0.09	0.7	<0.005	0.18
Q013953		860	719	1.1	<0.002	0.08	155.0	0.3	11	0.8	5.4	<0.05	2.51	<0.2	0.009	0.08
Q011239		1620	99.6	133.5	<0.002	0.02	4.32	4.0	2	6.4	27.0	4.16	0.07	20.0	0.276	1.61
Q011240		260	51.0	1.3	<0.002	<0.01	1.27	0.3	<1	0.2	17.0	<0.05	<0.05	0.2	0.008	0.08
Q011241		410	236	5.9	<0.002	<0.01	3.32	0.9	<1	0.7	53.1	0.18	<0.05	0.9	0.034	0.24
Q011242		280	133.5	168.0	<0.002	0.01	3.37	7.0	1	11.4	10.5	12.35	0.09	24.5	0.671	2.49
Q011243		10	18.0	0.5	<0.002	<0.01	0.34	0.1	<1	<0.2	47.6	<0.05	<0.05	<0.2	<0.005	0.02
Q011244		1330	1625	12.4	<0.002	<0.01	29.2	3.1	1	15.4	43.1	0.30	0.11	1.6	0.107	1.01
Q011245		460	62.2	1.0	<0.002	<0.01	4.26	0.3	<1	0.3	38.6	0.06	<0.05	0.4	0.013	0.04
Q011246		360	1650	0.7	<0.002	<0.01	21.5	0.4	6	0.7	11.3	<0.05	<0.05	<0.2	<0.005	0.17
Q011247		290	760	0.2	<0.002	<0.01	43.3	0.1	1	0.2	13.5	<0.05	<0.05	<0.2	<0.005	0.08
Q011248		440	47.0	1.6	<0.002	<0.01	1.48	0.3	<1	0.3	67.5	<0.05	<0.05	0.3	0.010	0.04
Q011249		30	14.8	0.3	<0.002	<0.01	0.73	0.1	<1	<0.2	55.7	<0.05	<0.05	<0.2	<0.005	<0.02
Q011250		>10000	430	0.7	<0.002	<0.01	9.96	1.7	1	0.9	75.4	<0.05	0.07	5.6	0.050	0.12
Q011251		3140	417	18.8	<0.002	<0.01	9.14	1.9	1	3.4	70.4	0.23	0.05	2.4	0.074	0.42
Q011252		7120	29.2	4.2	<0.002	<0.01	1.66	0.5	<1	0.3	88.6	0.05	<0.05	0.6	0.014	0.06
Q011253		5400	50.5	60.6	<0.002	0.43	10.80	15.8	16	1.2	66.8	0.94	0.23	10.9	0.199	3.07

***** See Appendix Page for comments regarding this certificate *****



ALS Canada Ltd.
 2103 Dollarton Hwy
 North Vancouver BC V7H 0A7
 Phone: 604 984 0221 Fax: 604 984 0218 www.alsglobal.com

To: ATAC RESOURCES LTD.
 C/O ARCHER, CATHRO & ASSOCIATES (1981)
 LIMITED
 1016-510 W HASTINGS ST
 VANCOUVER BC V6B 1L8

Page: 2 - D
 Total # Pages: 2 (A - D)
 Plus Appendix Pages
 Finalized Date: 19-AUG-2014
 Account: RCM

Project: RAV

CERTIFICATE OF ANALYSIS WH14120283

Sample Description	Method Analyte Units LOR	ME-MS61 U ppm	ME-MS61 V ppm	ME-MS61 W ppm	ME-MS61 Y ppm	ME-MS61 Zn ppm	ME-MS61 Zr ppm	Ba-XRF10 Ba %
Q011154		10.4	62	10.6	21.4	121	492	
Q011155		9.2	53	18.4	48.4	637	397	
Q011156		8.2	29	18.5	3.6	257	10.9	
Q011157		2.6	28	4.0	18.8	127	145.5	
Q011158		10.6	162	3.7	14.8	1500	137.5	1.02
Q013951		1.0	9	1.4	2.0	191	1.1	
Q013952		9.5	29	18.1	5.6	778	0.7	
Q013953		4.6	12	11.5	1.6	197	15.3	
Q011239		21.4	72	8.4	20.3	412	319	
Q011240		1.2	7	2.8	2.2	152	2.3	
Q011241		1.7	19	8.4	2.9	223	13.6	
Q011242		8.3	57	10.9	24.5	345	442	1.21
Q011243		0.7	3	0.3	0.5	36	1.5	
Q011244		3.5	48	37.2	7.7	1580	18.9	
Q011245		3.1	11	3.9	1.5	140	5.4	
Q011246		0.8	19	7.9	2.6	3810	1.6	
Q011247		0.4	12	4.4	1.3	921	<0.5	
Q011248		4.2	9	0.7	1.4	102	2.7	
Q011249		0.5	6	0.3	0.8	34	<0.5	
Q011250		53.0	58	5.5	28.8	893	30.8	
Q011251		14.9	53	8.2	4.1	534	23.8	
Q011252		44.6	23	0.5	3.9	121	7.1	
Q011253		11.1	200	2.2	29.1	234	174.0	



ALS Canada Ltd.
 2103 Dollarton Hwy
 North Vancouver BC V7H 0A7
 Phone: 604 984 0221 Fax: 604 984 0218 www.alsglobal.com

To: ATAC RESOURCES LTD.
 C/O ARCHER, CATHRO & ASSOCIATES (1981)
 LIMITED
 1016-510 W HASTINGS ST
 VANCOUVER BC V6B 1L8

Page: Appendix 1
 Total # Appendix Pages: 1
 Finalized Date: 19-AUG-2014
 Account: RCM

Project: RAV

CERTIFICATE OF ANALYSIS WH14120283

CERTIFICATE COMMENTS

ANALYTICAL COMMENTS

Applies to Method: REE's may not be totally soluble in this method.
 ME-MS61

LABORATORY ADDRESSES

Applies to Method: Processed at ALS Whitehorse located at 78 Mt. Sima Rd, Whitehorse, YT, Canada.
 CRU-31 CRU-QC LOG-21 SPL-21
 WEI-21

Applies to Method: Processed at ALS Vancouver located at 2103 Dollarton Hwy, North Vancouver, BC, Canada.
 Au-AA26 Ba-XRF10 Hg-CV41 ME-MS61
 ME-XRF10 OA-GRA06 PUL-31 PUL-QC

APPENDIX V
TIGER PRELIMINARY ECONOMIC ASSESSMENT

**Preliminary Economic Assessment (PEA)
NI 43-101 Technical Report on the Tiger Gold Project,
Yukon Territory, Canada**

Prepared for:



**Resources Ltd.
ATAC Resources Ltd.**

**1016-510 West Hastings Street
Vancouver, British Columbia
V6B 1L8, Canada**



Prepared by:



Kappes, Cassidy & Associates
7950 Security Circle
Reno, NV 89506

Report Date: 4 September 2014
PEA Effective Date: 23 July 2014

Authors:

Daniel Kappes, P.Eng.
Gary H. Giroux, P.Eng.
Sabry Abdel Hafez, Ph.D., P.Eng.
Robert L. McIntyre, R.E.T.
Gerald Carlson, Ph.D., P.Eng.

TABLE OF CONTENTS

1.0	SUMMARY	1-1
1.1	Introduction and Overview	1-1
1.2	Property Description and Ownership	1-1
1.3	Exploration and Mining History	1-3
1.4	Geology and Mineralization	1-3
1.5	Metallurgical Testwork	1-5
1.6	Mineral Resource and Reserves Estimate	1-6
1.7	Mining Methods	1-7
1.8	Recovery Methods	1-10
1.9	Infrastructure	1-12
1.10	Environmental and Permitting	1-12
1.11	Capital and Operating Costs	1-13
1.12	Economic Analysis	1-14
1.13	Interpretations and Conclusions	1-17
1.14	Recommendations	1-18
2.0	INTRODUCTION	2-1
2.1	Introduction and Overview	2-1
2.2	Project Scope and Terms of Reference	2-2
2.3	Frequently Used Acronyms, Abbreviations, Definitions and Units of Measure	2-4
3.0	RELIANCE ON OTHER EXPERTS	3-1
4.0	PROPERTY DESCRIPTION AND LOCATION	4-1
4.1	Location of Mineralization	4-5
5.0	ACCESSIBILITY, CLIMATE, LOCAL RESOURCES, INFRASTRUCTURE AND PHYSIOGRAPHY	5-1
6.0	HISTORY	6-1
7.0	GEOLOGICAL SETTING AND MINERALIZATION	7-1
7.1	Regional Geology	7-1
7.2	Property Geology	7-6
7.3	Deposit Scale Lithology	7-10
7.4	Mineralization	7-13
8.0	DEPOSIT TYPES	8-1
9.0	EXPLORATION	9-1
9.1	Soil Sampling	9-1
9.2	Surface Rock Sampling	9-7
9.3	Geological Mapping	9-11
9.4	Geophysics	9-11

10.0	DRILLING.....	10-1
10.1	Diamond Drilling Specifications	10-8
10.2	Core Logging and Collar Surveys.....	10-8
11.0	SAMPLE PREPARATION, ANALYSIS AND SECURITY	11-1
12.0	DATA VERIFICATION	12-1
13.0	MINERAL PROCESSING AND METALLURGICAL TESTING	13-1
13.1	Sulfide Petrography	13-1
13.2	Sulfide Flotation/Cyanidation Surveys.....	13-2
13.3	Sulfide Gold Department Studies	13-6
13.4	Sulfide Bio-Oxidation Studies	13-10
13.5	Oxide Metallurgy	13-11
14.0	MINERAL RESOURCE ESTIMATE.....	14-1
14.1	Introduction.....	14-1
14.2	Data Analysis	14-1
14.3	Composites.....	14-5
14.4	Variography	14-6
14.5	Block Model.....	14-7
14.6	Bulk Density	14-8
14.7	Grade Interpolation	14-13
14.8	Classification.....	14-15
15.0	MINERAL RESERVE ESTIMATES.....	15-1
16.0	MINING METHODS	16-1
16.1	Introduction.....	16-1
16.2	Pit Optimization.....	16-1
16.3	Mine Design.....	16-6
16.4	Production Schedule	16-8
16.5	Mine Waste Rock and Stockpile Management.....	16-12
16.6	Mining Equipment	16-12
16.7	Mining Labor	16-15
17.0	RECOVERY METHODS.....	17-1
17.1	Process Design Basis	17-1
17.2	Crushing.....	17-8
17.3	Scrubbing, Screening, Classification	17-8
17.4	CIL Circuit.....	17-9
17.5	Tailings Impoundment.....	17-9
17.6	Heap Leach Facility	17-11
17.7	Solution Management	17-13
17.8	Recovery Plant.....	17-13
17.9	Process Reagents and Consumables	17-15
17.10	Cyanide Destruction.....	17-16

17.11	Process Water Balance.....	17-16
17.12	Process Power Requirement.....	17-19
18.0	PROJECT INFRASTRUCTURE	18-1
18.1	Access & Facilities	18-1
18.2	Power Supply, Communication Systems & IT	18-6
18.3	Water.....	18-8
19.0	MARKET STUDIES AND CONTRACTS.....	19-1
20.0	ENVIRONMENTAL SETTING	20-1
20.1	Baseline Environmental Studies Overview	20-2
20.2	Tailings and Waste Rock Disposal Plan.....	20-5
20.3	Water Management.....	20-5
20.4	Project Permitting Requirements	20-5
20.5	Socioeconomic, Community Engagements	20-9
20.6	Mine Closure/ Reclamation Requirements and Costs	20-10
21.0	CAPITAL AND OPERATING COSTS.....	21-1
21.1	Capital Expenditures.....	21-1
21.2	Mining Capital	21-3
21.3	Process Capital Costs.....	21-4
21.4	Construction Indirect Costs.....	21-8
21.5	Sustaining Capital	21-10
21.6	Reclamation and Closure	21-10
21.7	Operating Costs.....	21-10
22.0	ECONOMIC ANALYSIS	22-1
22.1	Summary.....	22-1
22.2	Methodology.....	22-3
22.3	General Assumptions.....	22-3
22.4	Financial Model and Results.....	22-5
22.5	Sensitivity Analysis	22-10
23.0	ADJACENT PROPERTIES	23-1
24.0	OTHER RELEVANT DATA AND INFORMATION	24-1
25.0	INTERPRETATION AND CONCLUSIONS	25-1
26.0	RECOMMENDATIONS.....	26-1
27.0	REFERENCES	27-1
28.0	DATE AND SIGNATURE PAGE.....	28-1

TABLE OF TABLES

1.0	SUMMARY	
1-1	Claim Data	1-2
1-2	Tiger Deposit Oxide Blocks – Classified Indicated.....	1-6
1-3	Tiger Deposit Oxide Blocks – Classified Inferred.....	1-7
1-4	Mine Production Schedule.....	1-9
1-5	Support and Ancillary Equipment Requirements	1-10
1-6	Processing Design Criteria Summary	1-11
1-7	Required Authorizations	1-13
1-8	Tiger Gold Project Capital Cost Summary	1-14
1-9	Tiger Gold Project Operating Cost Summary.....	1-14
1-10	Life of Mine Financial Summary.....	1-16
1-11	Sensitivity Analysis (Pre-Tax).....	1-17
1-12	After-Tax Variation Based On Gold Price.....	1-17
1-13	Summary of Estimated Costs for Next Level of Study (Prefeasibility).....	1-21
2.0	INTRODUCTION	
2-1	Table of Responsibilities by Section.....	2-4
4.0	PROPERTY DESCRIPTION AND LOCATION	
4-1	Claim Data	4-3
7.0	GEOLOGICAL SETTING AND MINERALIZATION	
7-1	Regional Lithological Units (after Roots in Cathro, 2006).....	7-5
9.0	EXPLORATION	
9-1	Geochemical Characteristics for Soil Samples, Rau Property.....	9-3
10.0	DRILLING	
10-1	Tiger Deposit Mineral Resource Database Summary.....	10-1
11.0	SAMPLE PREPARATION, ANALYSIS AND SECURITY	
11-1	2008 Quality Control Samples.....	11-3
11-2	2009 Standard Sample Consensus Values	11-4
11-3	2009 ACME QAQC Standard and Blank Samples.....	11-6
11-4	Standard Sample Consensus Values	11-8
13.0	MINERAL PROCESSING AND METALLURGICAL TESTING	
13-1	Composite Data.....	13-3
13-2	Bulk Mineral Analysis Data.....	13-3
13-3	Phase I Cyanidation Results.....	13-4
13-4	Cumulative Balances for Phase I Rougher Flotation Tests	13-5
13-5	Cumulative Balances for the Phase II Rougher Flotation Tests	13-5
13-6	Cyanidation Results for Phase II Flotation Tails	13-5
13-7	Cumulative Balance for the Surface Science Rougher Flotation	

	Concentrates.....	13-6
13-8	Preliminary Oxide Cyanide Leach Results.....	13-11
13-9	Sulfide and Carbon Speciation.....	13-12
13-10	ABA Results.....	13-13
13-11	NAG Results.....	13-13
13-12	Multi-Element Analysis.....	13-14
13-13	Gravity Separation Results.....	13-16
13-14	Cyanidation Results.....	13-16
13-15	SGS Agglomeration Tests.....	13-18
13-16	SGS Column Test.....	13-18
13-17	Auger Hole Assays by Interval.....	13-21
13-18	Auger Composite Head Screen Analyses.....	13-22
13-19	KCA Agglomeration Test Results.....	13-24
13-20	Cyanide Column Leach Test Work Summary of Metal Extraction and Chemical Consumptions.....	13-25
13-21	Conventional Column Tests, Mercury on Carbon.....	13-26
13-22	Conventional Column Tests, Copper in Solution.....	13-26
13-23	Scrubber Oversize Column Test Results.....	13-27
13-24	Scrubber Materials Bottle Roll Test Results.....	13-29
14.0	MINERAL RESOURCE ESTIMATE	
14-1	Assay Statistics Sorted by Lithology.....	14-2
14-2	Assay Statistics from Solids.....	14-3
14-3	Gold Populations in Oxide Domain.....	14-4
14-4	Capped Assay Statistics from Solids.....	14-5
14-5	3 m Composite Statistics from Solids.....	14-6
14-6	Semivariogram Parameters for the Tiger Deposit.....	14-7
14-7	Average Unit Density.....	14-12
14-8	Average Unit Density – Scintrex.....	14-12
14-9	Kriging Parameters for the Tiger Deposit.....	14-14
14-10	Tiger Deposit All Blocks – Classified Indicated.....	14-18
14-11	Tiger Deposit All Blocks – Classified Inferred.....	14-18
14-12	Tiger Deposit Oxide Blocks – Classified Indicated.....	14-19
14-13	Tiger Deposit Oxide Blocks – Classified Inferred.....	14-19
14-14	Tiger Deposit Sulfide Blocks – Classified Indicated.....	14-20
14-15	Tiger Deposit Sulfide Blocks – Classified Inferred.....	14-20
16.0	MINING METHODS	
16-1	Scoping-level Pit Slope Design Recommendations.....	16-2
16-2	Pit Optimization Parameters.....	16-3
16-3	Pit Optimization Results.....	16-5
16-4	Pit Design Results.....	16-7

16-5	Production Schedule	16-10
16-6	Operational Delays Per Shift	16-13
16-7	Haulage Cycle Times	16-13
16-8	Primary Equipment Requirements	16-14
16-9	Support and Ancillary Equipment Requirements	16-15
16-10	LOM Maximum Salaried Staff Requirement	16-16
16-11	Operator and Maintenance Staff on Payroll.....	16-16
17.0	RECOVERY METHODS	
17-1	Processing Design Criteria Summary	17-1
17-2	Projected Annual Reagents and Consumables.....	17-16
17-3	Average Precipitation Water Balance – Tiger Gold Project.....	17-18
20.0	ENVIRONMENTAL STUDIES, PERMITTING AND SOCIAL OR COMMUNITY IMPACT	
20-1	Environmental Studies Overview	20-3
20-2	Senior Authorizations Required.....	20-6
20-3	Conceptual Closure Measures.....	20-11
21.0	CAPITAL AND OPERATING COSTS	
21-1	Capital Expenditures Summary	21-2
21-2	Summary of Mining Fleet Requirements.....	21-3
21-3	Summary of Mining Initial Capital Costs	21-4
21-4	Construction Indirect Costs.....	21-9
21-5	Relevant Consumables Prices	21-11
21-6	Mining Operating Cost Summary - Pre-production Period	21-12
21-7	Mining Operating Cost Summary – Production Period.....	21-12
21-8	Mining Operating Cost Summary – LOM	21-13
21-9	Process Operating Cost Summary	21-13
21-10	Summary of Process Labor Requirements and Wages	21-16
21-11	Summary of Reagent Costs and Consumption	21-18
22.0	ECONOMIC ANALYSES	
22-1	Life of Mine Financial Summary.....	22-2
22-2	Key Financial Parameters	22-6
22-3	Key Financial Model Results.....	22-6
22-4	Cash Flow Analysis	22-7
22-5	Sensitivity Analysis (Pre-Tax).....	22-10
22-6	After-Tax Variation Based On Gold Price.....	22-10
26.0	RECOMMENDATIONS	
26-1	Proposed Tiger Deposit Auger Holes and Trenching	26-4
26-2	Proposed Tiger Deposit Core Drill Holes.....	26-4
26-3	Summary of Estimated Costs for Next Level of Study (PFS)	26-5

TABLE OF FIGURES

4.0	PROPERTY DESCRIPTION AND LOCATION	
4-1	Project Location	4-2
4-2	Claim Locations	4-4
4-3	Mineralization and Occurrences	4-6
6.0	HISTORY	
6-1	Historical Grid and Contour Soil Sampling.....	6-2
6-2	Historical Geophysical Surveys.....	6-3
6-3	Historical Diamond Drilling	6-4
7.0	GEOLOGICAL SETTING AND MINERALIZATION	
7-1	Tectonic Setting	7-2
7-2	Regional Geology	7-4
7-3	Property Geology	7-7
7-4	Stratigraphic Section – Tiger Zone.....	7-11
9.0	EXPLORATION	
9-1	Soil and Stream Sediment Geochemistry	9-2
9-2	Gold Soil and Stream Sediment Geochemistry	9-4
9-3	Arsenic Soil and Stream Sediment	9-5
9-4	Bismuth Soil and Stream Sediment	9-6
9-5	Rock Sample Location.....	9-8
9-6	Modelled VTEM Anomalies.....	9-13
9-7	Modelled ZTEM Anomalies.....	9-15
10.0	DRILLING	
10-1	Drill Hole Locations	10-2
10-2	Tiger Section 10 + 000.....	10-4
10-3	Tiger Section 10 + 250.....	10-5
10-4	Tiger Deposit – Gold Gram x Metre Plot	10-7
13.0	MINERAL PROCESSING AND METALLURGICAL TESTING	
13-1	Gold Department Diagram with Relative Distribution of Gold per Carrier for Each Sample.....	13-8
13-2	Relative Gold Distribution in Sulfides.....	13-9
13-3	Bottle Roll Leach Kinetics.....	13-17
13-4	Coarse Ore Bottle Roll Leach Kinetics.....	13-17
13-5	SGS Column Test Recovery Curve	13-19

13-6	Tiger Auger Sampling Program.....	13-20
13-7	Size Distribution Auger Hole Composite	13-22
13-8	Scrubbed Oversize Column Test Recovery Graph	13-28
13-9	Gold Extraction vs. Time, Undersize Fraction	13-30
13-10	Silver Extraction vs. Time, Undersize Fraction.....	13-30
14.0	MINERAL RESOURCE ESTIMATE	
14-1	Isometric View Looking NE of the Oxide Solids in Red, Sulfide Solids in Yellow, Surface Topography in Grey and Drill Hole Traces	14-3
14-2	Lognormal Cumulative Probability Plot for Gold in Oxides.....	14-4
14-3	Histogram of Assay Sample Lengths.....	14-6
14-4	View Looking NE Showing Oxide Solids in Red, Sulfide Solids in Yellow, Surface Topography in Grey and Overburden in Orange	14-8
14-5	Scatter Plot Comparing Density to SG in Sulfide Samples	14-10
14-6	Scatter Plot Showing ATAC Measured Density Compared to Scintrex Density	14-13
14-7	Isometric Views Looking SE Showing Classified Blocks.....	14-17
16.0	MINING METHODS	
16-1	Tiger Gold Project Topography	16-3
16-2	Ultimate Pit Design.....	16-8
16-3	Production Schedule	16-11
16-4	LOM Mine Status Map	16-11
17.0	RECOVERY METHODS	
17-1	Simplified Process Flowsheet.....	17-5
17-2	Overall Site Layout.....	17-6
17-3	Process Layout	17-7
17-4	Tailings Dam Layout – Ultimate Crest.....	17-10
18.0	PROJECT INFRASTRUCTURE	
18-1	Project Access Roads	18-3
22.0	ECONOMIC ANALYSES	
22-1	Pre-Tax IRR vs. Gold Price, Capital Cost and Operating Cash Cost ..	22-11
22-2	NPV @ 0% vs. Gold Price, Capital Cost and Operating Cash Cost....	22-11
22-3	NPV @ 5% vs. Gold Price, Capital Cost and Operating Cash Cost....	22-12
22-4	NPV @ 8% vs. Gold Price, Capital Cost and Operating Cash Cost....	22-12

1.0 SUMMARY

1.1 Introduction and Overview

This Preliminary Economic Assessment (“PEA”) has been prepared at the request of Mr. Graham Downs, CEO of ATAC Resources Ltd. (“ATAC”, TSX-V: ATC) and documents a previously reported mineral resource estimate; new mining studies; new metallurgical studies; evaluations of processing options and plant throughput rates; investigations of site environmental status and regulatory requirements necessary for production; analysis of infrastructure and logistic strategies; and a preliminary economic model based upon the results of those studies that considers treating only the oxide mineralization at the Tiger Deposit, Rau Property located in east central Yukon, Canada.

The mineral resource estimate was prepared using drill data generated between 2008 and 2010, and was published previously on November 15, 2011. The resource estimate has not been updated since that time. This report was written in compliance with disclosure and reporting requirements set forth in the Canadian Securities Administration’s current “Standards of Disclosure for Mineral Projects” under the provisions of National Instrument 43-101, Companion Policy 43-101 CP and Form 43-101F1.

The PEA is preliminary in nature. It includes inferred mineral resources that are considered too speculative geologically to have the economic considerations applied to them that would enable them to be categorized as mineral reserves, and as such there is no certainty that the project as outlined in the PEA will be realized.

1.2 Property Description and Ownership

The Rau Property (“the Property”) lies 98 km northeast of Mayo and is centered at 64.19° N latitude and -134.44° W longitude in east central Yukon. The closest road access is to the community of Keno City, situated 49 km by road northeast of Mayo and 55 km by air southwest of the Property. Mayo and Keno City can be reached in all seasons by two wheel drive vehicles using the Yukon highway system from Whitehorse, Yukon. The Wind River Trail, classified as a “winter road”, starts at McQuesten Lake near Keno City and crosses the central portion of the Property. The Wind River Trail has been used intermittently by various exploration companies since it was built in the late 1960’s and most recently in 2007 as a winter fuel route into the Wernecke Mountains.

Access for construction and mining for the Tiger Gold Project (“the Project”) is currently envisioned as by winter-only road, and is thus constrained by the Beaver River. Materials for construction and consumables must be delivered during winter months when road access is possible to cross the frozen river. During summer months all access is by plane or helicopter. There is an existing air strip located 8 km from the proposed mine, which would be connected by an all-weather road.

The climate at the Property is typical of northern continental regions with long, cold winters, short fall and spring seasons and mild summers. Snowfall can occur in any month at higher elevations. The Property is mostly snow-free from early June to late September.

The Property consists of 2,797 contiguous quartz mineral claims on NTS map sheets 106D/01, 106D/02, 106D/06, 106D/07 & 106D/08 (Figure 4-1). The Property covers an area of 57,671 hectares (576.7 km²). The claims are registered with the Mayo Mining Recorder in the name of Archer, Cathro & Associates (1981) Limited (“Archer Cathro”), holding them in trust for ATAC. ATAC owns the Property 100%, with no underlying interests. The claims and expiry dates as of June 2, 2014, are presented in Table 1-1.

Table 1-1
Claim Data

Claim Name(s)	Grant Number(s)	Expiry Date
GF 3-4	YC32305-YC32306	April 28, 2029
Q 1-13	YC92361-YC92373	April 28, 2026
Q 14	YC92470	April 28, 2026
Q 15-109	YC92375-YC92469	April 28, 2026
R 1-103	YC68334-YC68436	April 28, 2028
R 105-1295	YC68438-YC69628	April 28, 2028
R 1296-1337	YC70595-YC70636	April 28, 2025
Rau 1-64	YC50268-YC50331	April 28, 2035
Rau 65-96	YC57529-YC57560	April 28, 2028
Rau 97F-98F	YC69925-YC69926	April 28, 2029
Rau 99F-100F	YC69961-YC69962	April 28, 2029
S 1-700	YC90801-YC91500	April 28, 2026
S 701-842	YC91901-YC92042	April 28, 2026
S 843	YC92355	April 28, 2026
S 844-1154	YC92044-YC92354	April 28, 2024
S 1155-1244	YD09635-YD09724	March 1, 2019
S 1245-1246	YD09725-YD09726	March 1, 2021
S 1247	YD09727	March 1, 2019
S 1248	YD09728	March 1, 2021
S 1249-1250	YD09729-YD09730	March 1, 2019

1.3 Exploration and Mining History

The earliest reported exploration within the area occurred in 1922 following the discovery of silver mineralization at Keno Hill, when prospectors first identified and staked mineralized float occurrences at Carpenter Ridge in the far northwest corner of the Property.

ATAC became interested in the location of an isolated, high gold value (150 ppb) reported by a regional-scale stream sediment geochemical survey, conducted by the Geological Survey of Canada (Hornbrook et al, 1990). ATAC has undertaken the following exploration activities on the Property:

- In 2006, staked 64 claims to cover the anomalous drainage;
- In 2007, completed geological mapping, prospecting, grid soil sampling, and Vertical Time Domain Electromagnetic (VTEM) surveys, and staked an additional 32 claims;
- In 2008, conducted geologic mapping, prospecting, soil and stream sediment geochemical sampling, 3,423.2 m of diamond drilling in 18 holes, property-wide VTEM surveys identifying the Tiger Deposit and staked an additional 1,340 claims;
- In 2009, conducted prospecting and continued to delineate the Tiger Deposit with an additional 58 drill holes totaling 9,578.3 m;
- In 2010, continued exploration with 18,450.4 m of diamond drilling, primarily focused within the Tiger Deposit;
- Initiated various metallurgical programs between 2009-2014;
- In 2013, auger-drilled new samples and sent material to Kappes Cassidy & Associates (“KCA”) for metallurgical testing.

1.4 Geology and Mineralization

The Rau Property lies within a band of regional-scale thrust and high angle reverse faults that imbricate rocks of Selwyn Basin and Mackenzie Platform. Selwyn Basin stratigraphy consists of regionally metamorphosed, basinal sediments of Neoproterozoic to Paleozoic age. Mackenzie Platform stratigraphy comprises dominantly shallow water carbonate and clastic sediments that were deposited from Mid-Proterozoic through

Paleozoic times. Both packages of sediments were deposited on the western margin of ancestral North America.

Thrust faults were active during Jurassic to Cretaceous times (160 to 130 Ma) when the area underwent compressional orogenesis related to large-scale plate convergence. During Late Cretaceous (94-90 Ma) intermediate to felsic plutons of the Tombstone Suite were emplaced. Another compressional orogenic event occurred about 65 Ma and was accompanied by emplacement of felsic intrusions assigned to the McQuesten Suite.

The Tombstone, Dawson and Robert Service thrust faults plus a number of lesser thrust faults affect stratigraphy along the trend of the Rau claim block. All thrusts verge northeasterly and predate emplacement of the Tombstone Suite intrusions. The thrust panel that contains the Rau Property approximately straddles the boundary between Selwyn Basin and Mackenzie Platform and includes units belonging to both tectonic elements.

The Rau Property lies within a northwest trending thrust package bound to the south by the Dawson Thrust and to the north by the Kathleen Lakes Fault. The stratigraphic units within this package form open folds that are aligned parallel to the thrusts and plunge gently to the southeast. Several high angle faults that parallel the general structural trend are inferred on the property and others could be present. One or more of these faults are interpreted to have acted as conduits for mineralizing fluids.

Mineralization at the Tiger Deposit is hosted by carbonates of the regionally extensive Bouvette Formation. Replacement style gold mineralization has been the primary focus of exploration on the Rau Property and the Tiger Deposit is the best understood and most aggressively explored type of occurrence identified to date.

The Tiger Deposit is a thick northwesterly trending body of carbonate replacement style gold mineralization hosted by a moderately northeast dipping horizon. As it is currently known, the Tiger Deposit is 700 meters long, 100 to 200 meters wide and up to 96 meters thick. Mineralization is developed within and adjacent to a regionally extensive corridor of highly strained carbonate rocks that is manifested as a 40 to 150 meter wide zone of small scale folding and shearing. The geometry of the mineralized system is defined by a series of stacked and folded limestone horizons intercalated with locally extensive mafic flows and volcanoclastic units.

Gold occurs in both sulfide and oxide facies type mineralization. Sulfide mineralization is accompanied by, and developed within, limestone that is replaced by ferruginous

dolomite and iron carbonate minerals. Oxide mineralization is completely devoid of sulfide minerals and ranges from very competent, weakly porous limonitic mud to rubbly porous limonitic grit. The oxide appears texturally amorphous within most intersections but occasionally exhibits residual color banding that may represent relict sulfide textures. Complete oxidation extends up to a depth of 250 meters from surface.

Based on these observations associated with the Tiger Deposit mineralization, the most suitable classification is “sediment-hosted Nevada-type carbonate replacement style” gold mineralization.

1.5 Metallurgical Testwork

Metallurgical testwork has been conducted on the potential sulfide and oxide material comprising the Tiger Deposit mineralization. The following test programs were conducted by independent contractors over a six year period:

- Sulfide petrographic studies – Micron Geological Ltd. (BC) 2009/2010
- Sulfide Flotation / Cyanidation Surveys – G&T Metallurgical Services (BC) 2009/2010
- Gold deportment studies – Surface Science Western (ON) 2010
- Bio-oxidation studies – SGS Minerals Services (ON) 2010/2011
- Oxide cyanidation – ALS Group (BC) 2009
- Oxide cyanidation, Carbon-In-Leach (“CIL”) and preliminary heap leach investigations – SGS Minerals Services (ON) 2010-2012
- Oxide heap leach and hybrid process investigations – KCA (NV) 2013/2014

The main conclusions from the most recent test work performed by KCA for a hybrid CIL/heap leach, which forms the basis for the present study, are presented below:

- Conventional heap leaching of the Tiger oxide material is not viable due to high cement requirements necessary to obtain stable agglomerates.
- A hybrid heap / CIL approach was tested and appears to be a viable alternative process.
- The size split between the CIL and heap leach is 0.212 mm with the +0.212 mm material (“oversize”) being delivered to the heap leach and the -0.212 mm material (“undersize”) being delivered to the CIL. Approximately 42% of the material is oversize.

- The heap leach cycle time is 50 days, with an estimated gold recovery of 87.8% and a silver recovery of 19.0%.
- The retention time for the CIL circuit is 24 hrs, with an estimated gold recovery of 91.0% and a silver recovery of 19.0%.

1.6 Mineral Resource and Reserves Estimate

The resource estimate is based on 133 diamond drill holes totaling 25,562 m and 5,881 assays. Geologic continuity for the deposit has been established through geologic mapping and drill hole logging. The geologic continuity has been used to constrain the oxide and sulfide mineralized domains. The grade continuity, which can be quantified by semivariograms, has been used to classify the estimate.

The oxide resource is tabulated in Tables 1-2 and 1-3.

**Table 1-2
Tiger Deposit Oxide Blocks - Classified Indicated**

Au Cut-off (g/t)	Tonnes > Cut-off (tonnes)	Grade > Cut-off		Contained Metal	
		Au (g/t)	Ag (g/t)	Au (ozs)	Ag (ozs)
0.10	5,080,000	2.42	5.77	395,300	942,400
0.20	4,790,000	2.56	5.66	394,300	871,700
0.30	4,490,000	2.71	5.49	391,200	792,500
0.40	4,200,000	2.88	5.42	388,900	731,900
0.50	3,970,000	3.02	5.42	385,000	691,800
0.60	3,800,000	3.13	5.41	382,400	661,000
0.70	3,640,000	3.24	5.46	379,200	639,000
0.80	3,480,000	3.35	5.47	374,800	612,000
0.90	3,300,000	3.49	5.46	370,300	579,300
1.00	3,150,000	3.61	5.52	365,600	559,000
1.20	2,900,000	3.82	5.54	356,200	516,500
1.40	2,700,000	4.02	5.54	349,000	480,900
1.60	2,470,000	4.25	5.47	337,500	434,400
1.80	2,260,000	4.48	5.36	325,500	389,500
2.00	2,080,000	4.72	5.29	315,600	353,800

**Table 1-3
Tiger Deposit Oxide Blocks - Classified Inferred**

Au Cut-off (g/t)	Tonnes > Cut-off (tonnes)	Grade > Cut-off		Contained Metal	
		Au (g/t)	Ag (g/t)	Au (ozs)	Ag (ozs)
0.10	790,000	1.17	6.17	29,700	156,700
0.20	740,000	1.23	5.96	29,300	141,800
0.30	620,000	1.42	5.31	28,300	105,800
0.40	500,000	1.67	4.51	26,800	72,500
0.50	440,000	1.85	4.46	26,200	63,100
0.60	420,000	1.91	4.51	25,800	60,900
0.70	400,000	1.97	4.54	25,300	58,400
0.80	380,000	2.05	4.51	25,000	55,100
0.90	350,000	2.15	4.35	24,200	49,000
1.00	320,000	2.27	4.35	23,400	44,800
1.20	250,000	2.59	4.56	20,800	36,700
1.40	220,000	2.73	4.48	19,300	31,700
1.60	180,000	3.00	3.92	17,400	22,700
1.80	150,000	3.29	3.37	15,900	16,300
2.00	130,000	3.53	2.73	14,800	11,400

A mineral reserve has not been estimated for the Project.

1.7 Mining Methods

The mining study was based on a nominal process capacity of approximately 520,000 t/a. The final designed pit includes approximately 2.1 million tonnes of mineralized material and 11.5 million tonnes of waste rock. The Life of Mine (“LOM”) strip ratio (defined as waste material mined divided by mineralized material mined) is 5.58.

The proposed open pit mine will utilize a conventional truck-and-excavator fleet. Based on the geotechnical recommendations provided by Golder Associates in their scoping level pit slope evaluation report entitled “Tiger Zone Project – Yukon Territory, Canada” dated January 27, 2014, blasting will be performed only on waste rock while oxide material will be excavated directly by a hydraulic excavator.

The mining schedule is based on a nominal processing capacity of 3,300 t/d of ore for 158 d/a. Pit optimization and production scheduling have been performed using the indicated and inferred oxide resources while sulfide resources have been treated as waste; only oxide material above the economic cut-off will be scheduled for processing. Oxide material below the economic cut-off and all sulfide material will be handled as waste.

Relatively high grade material will be sent directly to the primary crusher, located southwest of the pit. Low grade material will be stockpiled close to the primary crusher. Waste material will be stored in a waste dump (“WD”) located at the southwest side of the pit.

Mining will be conducted year round of both ore and waste in order to stockpile and feed ore to the seasonal processing operation at capacity.

Assumed mining dilution and mining recovery factors are 5% and 95%, respectively.

The Project’s total mine life is 5 years, including 1 year of pre-stripping followed by 4 years of production. The production schedule is shown in Table 1-4. The LOM average diluted gold grade is 3.72 g/t.

**Table 1-4
Mine Production Schedule**

Year	Mine to Process (t)	Mine to Stockpile (t)	Stockpile to Process (t)	Material Processed (t)	Head Grade (g/t)	Waste (t)	Total Mined (t)	Strip Ratio	Material in Stockpile (t)
-1	-	437,645	-	-	-	1,062,355	1,500,000	2.43	437,645
1	196,798	266,101	319,402	516,200	5.27	3,137,101	3,600,000	6.78	384,344
2	138,696	93,227	377,504	516,200	3.21	3,368,076	3,600,000	14.52	100,068
3	415,916	79,138	100,068	515,984	3.79	3,104,947	3,600,000	6.27	79,138
4	435,901	-	79,138	515,038	2.61	837,393	1,273,294	1.92	-
Total	1,187,311	876,111	876,112	2,063,422	3.72	11,509,872	13,573,294	5.58	-

Small mining equipment with operating flexibility was selected to match the pit production schedule and the nature of site. The equipment selection, sizing, and fleet requirements were based on anticipated site operating conditions, haulage profiles, cycle times, and overall equipment utilization. Loading will be performed using a 6.5 m³ hydraulic excavator and hauling will be performed using 39-t articulated trucks. Blasthole drilling will be performed using 4.5" percussion crawler drills. Support and ancillary equipment are presented in Table 1-5.

**Table 1-5
Support and Ancillary Equipment Requirements**

Equipment	Maximum Fleet Size
Track Dozer, 9.8 ft (2.9 m)	2
Wheel Dozer, 12 ft (3.6 m)	1
Grader, 12 ft (3.6 m)	1
Water Truck, 5000 gal (18,930 L)	1
Service Loader	1
Secondary Drill	1
Vibratory Compactor	1
Integrated Tool Carrier	1
Excavator	1
Flatbed Truck	1
Fuel/Lube Truck	1
Mechanics Service Truck	1
Welder Truck	1
Tire Service Truck	1
Snow/Sand Truck	1
Pickup Truck	4
Mobile Crane	1
Rough Terrain Forklift	1
Shop Forklift	1
Light Plant	8
Dispatch System	1
Mobile Radios	100
Safety Equipment	1
Engineering/Geology Equipment	1
Maintenance Management System	1
Surveying	1

1.8 Recovery Methods

Test work results to date have indicated that the mineralized material is amenable to cyanide leaching. However, due to the very high clay content (approximately 58% -200

mesh) in situ, very high cement additions are required for conventional agglomeration and heap leaching. Further, due to the limited extent of the deposit a full milling scenario has shown to yield a marginally economic project.

This study details a hybrid processing option. Run of mine (“ROM”) ore will be fed into a MMD mineral sizer, followed by a scrubber to wash and separate the clays. The fines will be treated in a small CIL circuit while the clean sand and gravel-sized material will be heap leached conventionally (no cement agglomeration) as a single 10 m lift on a single-use, permanent leach pad. Loaded carbon from the heap and CIL is processed in a shared recovery plant where precious metals are stripped from carbon, plated onto stainless steel cathodes by electrowinning and the resulting sludge is washed from the cathodes, filtered, retorted to remove mercury and then smelted to produce Doré bullion.

A summary of the processing design criteria is presented in Table 1-6.

Table 1-6
Processing Design Criteria Summary

Item	Design Criteria
Annual Tonnage Processed	500,000 t/a
Average Feed Grade	Au: 3.72 g/t Ag: 5.0 g/t*
Production Rate	3,300 t/d, 158 days per year
Processing	CIL: 1,913 t/d (58% of feed) Heap Leach: 1,387 t/d (42% of feed)
Recovery of Gold	CIL: 91.0% Heap Leach: 87.8%
Recovery of Silver	CIL: 19.0% Heap leach: 19.0%
Crushing Operation	12 hours/shift, 2 shifts/day, 7 days/week, 158 days per year
Crusher Availability	75%
Heap Leaching Cycle	50 days

*Note: Silver grade was not scheduled and is assumed constant at 5.0g/t

Because of the remote location, difficult access, and moderately severe winters, the project is considered seasonal with respect to processing with a 158 day operating year. Most bulk reagents and supplies will be transported to the site by road during winter and stockpiled for use during the spring/summer operating season when access is only by air. Although the processing is seasonal, mining will occur as required year round, independent of the processing season.

1.9 Infrastructure

Primary access to the project site is by a new winter road from the head of the Yukon road system, at Hansen Lakes (approximately 51.6 km). This road will only be accessible during the winter as it requires an ice crossing of the Beaver River. The access road will utilize portions of the existing Wind River Trail that may require improvements including widening and crowning to improve road safety for transportation of heavy loads during construction and regular operations traffic after mine start-up. During the summer when the ice crossing is not available access will be by plane using an existing airstrip. An 8.2 km all-season road will provide access to the proposed mine and plant site from the camp/airstrip area.

Power will be supplied by two 1,750 kW diesel generators (one operating and one standby) located between the process plant and tailings dam. Power will be distributed by power lines to all areas except the camp, which will have its own small generators. The average power draw is estimated to be 1,156 kW, not including the MMD sizer which is equipped with a 400 kW on-board generator.

Water for process uses is expected to be sourced from nearby creeks or the Beaver River. The peak water demand for process is 16 m³/hr, and will only occur during summer months.

Project buildings will include a mine truck shop/warehouse, administration building, a mill building, mine camp, and a modular laboratory. With the exception of the laboratory, all buildings will be prefab insulated fabric buildings. The laboratory will be a containerized unit.

1.10 Environmental and Permitting

Environmental characterization of the Tiger Gold Project has been on-going since 2010. ATAC has developed a robust baseline environmental characterization that is anticipated to provide most information necessary to support environmental and socioeconomic assessment and permitting under Yukon and Federal legislation for advanced development.

Prior to production, the Project will require the following senior authorizations listed in Table 1-7.

**Table 1-7
Required Authorizations**

Mine criteria trigger	Authorization Required	Issuing Agency	Legislation
>100 tpd gold mine	Yukon Environmental and Socioeconomic Assessment Act (“YESAA”) Decision Document	Issued by Decision Body (Government of Yukon, Energy, Mines & Resources), after evaluation at the Executive Committee level of the Yukon Environmental and Socioeconomic Assessment Board	YESAA, <i>Assessable Activities, Exceptions and Executive Committee Projects Regulations</i>
Commencement of commercial production	Quartz Mining License	Yukon Government, Energy Mines & Resources	Quartz Mining Act, <i>Mining Land Use Regulations</i>
Use of water for milling, use of >300 cubic meters per day, deposit of a waste	Type A Water Use License	Yukon Water Board	Waters Act, <i>Waters Regulations</i>

1.11 Capital and Operating Costs

Capital and operating costs for the Tiger Gold Project were estimated by KCA and Tetra Tech, Inc. (“Tetra Tech”) with input from ATAC. The estimated capital costs are considered to have an accuracy of +/-35%. A contingency of 20% has been applied to all capital costs.

Unless otherwise noted, all costs are presented in 1st quarter 2014 Canadian dollars. As required for presentation United States Dollars are specified as “USD”. Where applicable an exchange rate of 1 CAD = 0.92 US Dollars (“USD”) was used. These costs do not include Government Sales Tax (“GST”).

The total LOM capital cost is \$124.9 million. The total LOM operating cost for process and G&A is \$27.21/t processed. The LOM mining operating cost (not including capitalized pre-production mining) is \$4.46/t mined (\$4.69/t mined including capitalized pre-production mining). Tables 1-8 and 1-9 present the capital and operating costs for the project.

**Table 1-8
Tiger Gold Project Capital Cost Summary**

Description	Cost
Pre-Production Capital	\$92,261,000
Initial Fills	\$713,000
Working Capital (60 days)	\$5,388,000
Sustaining Capital*	\$26,508,000
Total*	\$124,870,000

*Total difference due to rounding.

The required capital costs include the estimation of costs for all mining equipment, pre-production mining, process facilities and infrastructure, and 20% contingency. The process and infrastructure capital costs have been estimated by KCA and mining capital costs have been estimated by Tetra Tech. Capital cost estimates have been made using budgetary supplier quotes, recent quotes of similar equipment, and new estimates based on KCA and Tetra Tech's experience with similar sized projects. All capital estimates are based on the purchase of equipment quoted new from the manufacturer or estimated to be fabricated new.

Operating costs for the project have been estimated from first principles using labor cost, material consumptions, and prices and unit costs. Labor costs are estimated using project specific staffing. Unit consumption of materials, supplies, power and delivered supply costs are also estimated.

**Table 1-9
Tiger Gold Project Operating Cost Summary**

Description	LOM Cost
Mine	\$4.46/t
Process	\$20.10/t processed
G&A	\$7.11/t processed

1.12 Economic Analysis

Based on the estimated production parameters, revenue, capital costs, and operating costs, taxes and royalties, a cash flow model was prepared by KCA for the economic analysis of the Tiger Gold Project. All of the information used in this economic evaluation has been taken from work completed by KCA and other consultants working on the Project, as described in previous sections of this report.

Pre-tax estimates were prepared for comparative purposes, while after-tax estimates were developed to approximate the true investment value. It must be noted, however, that tax estimates involve many complex variables that can only be accurately calculated during operations and, as such, the after tax results are only approximations. The reader is cautioned that the gold price and exchange rate used in this study are only estimates based on recent historical performance and there is absolutely no guarantee that they will be realized if the Project is taken into production. The gold price is based on complex factors and there are no reliable long-term predictive tools.

The Project economics were evaluated using a Discounted Cash Flow (“DCF”) method, which estimates the Net Present Value (“NPV”) of future cash flow streams. The final economic model was developed by KCA, with input from ATAC and Tetra Tech, using the following assumptions:

- Period of analysis of 6 years, including 1 year of pre-production and investment, 4 years of production, and one year for reclamation and closure (all closure costs assumed in first year of reclamation and closure for purposes of the PEA);
- Q1 2014 Canadian Dollars;
- Base Case gold price of USD 1,250/oz ;
- Exchange rate of CAD 1 = USD 0.92;
- Year-round mining;
- Seasonal processing for 158 days per year;
- Processing rate of 3,300 tonnes per day;
- Gold recoveries of 87.8% for the heap leach and 91.0% for CIL;
- Capital and operating costs as developed in Section 21 of this report;
- Project-specific closure cost estimate; and,
- Mine production schedule which includes inferred resources.

The project economics from the cash flow model based on these criteria are summarized in Table 1-10. A pre-tax sensitivity analysis is presented in Table 1-11. An after-tax sensitivity analysis based on gold price is presented in Table 1-12.

**Table 1-10
Life of Mine Financial Summary**

Financial Analysis	
Internal Rate of Return, Pre-Tax	30.0%
Internal Rate of Return, After-Tax	21.5%
NPV @ 5%, Pre-Tax (millions)	\$52.15
NPV @ 5%, After-Tax (millions)	\$33.67
Gold Price Assumption (USD/oz)	\$1,250
Silver Price Assumption (USD/oz)	\$19
Payback Period, Pre-Tax (years)	2.2
Payback Period, After-Tax, (years)	2.6
All-in Sustaining Capital Cost* (\$/oz)	626
Capital Costs (Excluding GST)	
Initial Capital, Including Contingency (millions)	\$92.26
Working Capital and Initial Fills (millions)	\$6.10
Mine Sustaining Capital (millions)	\$2.02
Process Sustaining Capital (millions)	\$24.49
Operating Costs (Average Life of Mine)	
Mining, Excluding Pre-Production (\$/t mined)	\$4.46
Process & Support (\$/t processed)	\$20.10
G&A (\$/t processed)	\$7.11
Production Data	
Life of Mine (years)	4
Mine Throughput, (Avg. t/d)	3,300
Metallurgical Recovery, Au	89.8%
Average Annual Gold Production (oz)	55,389
Metallurgical Recovery, Ag	19%
Average Annual Silver Production (oz)	15,764
Total Gold Produced, AuEq (oz)	222,516
Average LOM Strip Ratio (waste:ore)	5.58

* As defined by the World Gold Council, less corporate G&A

**Table 1-11
Sensitivity Analysis (Pre-Tax)**

Variation		IRR	NPV			Payback	
			0%	5%	8%	Years	
Gold Price (USD/oz)							
	USD 1,100.00	15.5%	\$36,731,635	\$21,429,853	\$14,054,316	2.9	
	USD 1,250.00	30.0%	\$72,675,385	\$52,147,446	\$42,145,333	2.2	
	USD 1,350.00	39.5%	\$96,637,783	\$72,625,755	\$60,872,599	1.8	
	USD 1,500.00	53.5%	\$132,581,267	\$103,343,123	\$88,963,412	1.3	
Capital Cost (% of Base Case)							
	80%	\$93,958,143	48.0%	\$95,505,695	\$73,547,123	\$62,771,384	N/A
	90%	\$105,373,298	38.1%	\$84,090,540	\$62,847,284	\$52,458,358	N/A
	100%	\$116,788,454	30.0%	\$72,675,385	\$52,147,446	\$42,145,333	N/A
	110%	\$128,203,609	23.3%	\$61,260,230	\$41,447,608	\$31,832,307	N/A
	120%	\$139,618,764	17.6%	\$49,845,075	\$30,747,769	\$21,519,281	N/A
Average Operating Cost (% of Base Case)							
	80%	\$70,364,412	44.9%	\$112,255,367	\$85,765,635	\$72,777,506	N/A
	90%	\$89,054,959	38.0%	\$93,564,820	\$69,890,379	\$58,312,313	N/A
	100%	\$109,944,393	30.0%	\$72,675,385	\$52,147,446	\$42,145,333	N/A
	110%	\$133,032,716	21.0%	\$49,587,062	\$32,536,836	\$24,276,565	N/A
	120%	\$158,319,926	10.6%	\$24,299,852	\$11,058,549	\$4,706,009	N/A

**Table 1-12
After-Tax Variation Based on Gold Price**

Variation		IRR	NPV			Payback
			0%	Years	8%	Years
Gold Price (USD/oz)						
	USD 1,100.00	11.2%	\$26,347,824	\$12,606,132	\$6,015,968	3.2
	USD 1,250.00	21.5%	\$50,998,189	\$33,673,501	\$25,286,492	2.6
	USD 1,350.00	27.9%	\$67,273,695	\$47,489,069	\$37,873,240	2.3
	USD 1,500.00	37.2%	\$91,460,726	\$68,026,015	\$56,586,562	1.9

1.13 Interpretations and Conclusions

The Tiger Gold Project open pit mine will utilize a conventional truck-and-excavator fleet. The Project's total mine life is 5 years, including 1 year of pre-stripping followed by 4 years of production. Closure and reclamation activities will take 2 years, with all costs modeled in the first year of closure for purposes of the PEA. Over the 5 year mine life, the pit will produce 2 million tonnes of mineralized material and 11.5 million tonnes of waste rock. The LOM average diluted gold grade is 3.72 g/t. The LOM stripping ratio is 5.58.

Metallurgical testing has indicated that the oxide material is amenable to cyanide leaching; however, high cement additions are required for conventional agglomeration and heap leaching due to the high clay content. Trade-off studies have shown that

conventional milling resulted in marginal project economics due to the small size of the resource. A hybrid processing option where the fine material is treated in a small CIL circuit and the coarse material is treated by conventional heap leaching has been considered for this study.

Based on the PEA study, the LOM capital expenditure required for the hybrid process is \$124.9 million including \$93 million for pre-production and \$5.4 million in working capital. The average annual operating cost for the process is \$20.10/t processed and \$7.11/t processed for G&A. The mining cost (not including capitalized pre-production) is \$4.46/t mined. The project is projected to produce 221,400 payable ounces of gold at a total all-in sustaining cash cost (as defined by the World Gold Council less corporate G&A) of \$626/oz. The pre-tax Internal Rate of Return (“IRR”) is 30.0%.

1.14 Recommendations

Based on the results of the PEA, KCA recommends the following future work:

- The Project should proceed to the prefeasibility level;
- Additional studies on site infrastructure, including the water systems, water sources, and site access;
- Optimization of the power systems with respect to attached loads and power distribution;
- Further optimization of labor, shift schedules, man camp, and light vehicles to refine the operating cost estimates;
- Further studies on reagent purchasing and logistics;
- Confirmatory metallurgical testwork, particularly with respect to: the mass and grade split between the fine and coarse material, leach retention times for the CIL and heap, cyanide destruction, and heap rinsing;
- Tests to determine the crushing work index and abrasion index should be performed on the material to better estimate wear and maintenance for crushing equipment;
- Tests for slurry rheology and flocculent requirements should be performed;
- Additional studies may be beneficial to evaluate other mining rates, mine life, or possible year round operation;
- Additional geotechnical site investigations for the leach pad and plant areas; and
- An investigation of extending the existing power line from the Keno Hill area should be performed. Although the power cost for this option is still high and the

power line would need to span a large distance, potential operating savings could be realized.

The estimated cost for the additional metallurgical and infrastructure development will be approximately \$600,000.

Tetra Tech makes the following recommendations for future work:

- The project should proceed to the prefeasibility level. A detailed mining production schedule and design should be developed with detailed mining activities to understand the potential constraints and cost reduction opportunities;
- As the pit optimization and scheduling results are highly dependent on the geotechnical parameters, more detailed geotechnical studies and/or fieldwork should be conducted to better define the appropriate pit slope angles and design parameters for the pit, stockpile and waste dump; and
- To estimate pit dewatering requirements, a hydrogeological study should be completed;
- A detailed characterization of mine waste material should be completed to enhance the waste management design;
- A trade-off study between owner and contract mining is recommended. Given the short life time, leasing of a mining fleet could also enhance the project economics.

The estimated cost for the proposed mining work will be approximately \$375,000.

Resource Strategies makes the following recommendations:

- Continue monthly hydrology monitoring program with the addition of flow measurements to provide data necessary for metal loading calculations;
- A subsurface hydrological investigation should be undertaken prior to future stages of study. In this investigation data will be collected and analyzed to provide an accurate characterization of groundwater depth, flow and quality to be potentially affected by the pit, leach pad, and tailings areas;
- Ensure wildlife reports from ongoing work are completed. Wildlife gaps to be reported on include wolverine, pika, raptors, waterfowl as well as a bear denning survey;
- Ensure completion of a rare plant assessment study currently in progress;
- Once the final mine plan/project footprint is determined, a Heritage Resource Impact Assessment must be conducted to determine if any heritage conflicts exist;

- Geochemical characterization of all representative lithologies should be commenced prior to future study. Static Acid-Base Accounting (“ABA”) should suffice to commence assessment under the Yukon Environmental and Socio-Economic Assessment Act (“YESAA”); kinetic ABA may be required for water licensing if concerns are identified during preliminary assessment;
- Geochemical characterization of borrow sources and overburden stripping areas will also be required.

Develop a detailed management plan for the proposed operation for the following:

- Vegetation, Wildlife, and Fish and Fish Habitat management plans. The Fish and Fish Habitat Management Plan should include habitat impact mitigation and compensation plans that satisfy section 35(2) of the Fisheries Act (if necessary);
- Access Road Management Plan, including traffic management and safety on access road and construction site, and maintenance of roads;
- Mine Leachate / Acid Rock Drainage (“ML/ARD”) Prediction and Prevention and Waste Rock and Tailings management plans;
- Management plans for water, air emissions and fugitive dust, noise, and soil;
- Hazardous goods storage and domestic and industrial solid waste management plans;
- Erosion control and sediment control plan;
- Spill contingency and emergency response plan;
- Airport and aircraft management plan;
- Archaeological and heritage site protection plan; and
- Construction plan, including provision for environmental supervision.
- A detailed decommissioning and reclamation plan will be required.
- Documentation of formalized socioeconomic consultation is a requirement for Yukon Environmental and Socioeconomic Assessment Board (“YESAB”) submissions at the Executive Committee level; ATAC will also need to negotiate an enhanced agreement (Impacts Benefit Agreement) with the impacted first nations, encompassing production.

The estimated cost for the proposed environmental work will be approximately \$500,000.

Giroux Consultants Ltd. makes the following recommendations for future work:

A program of trenching, auger drilling and core drilling is recommended to add to the current resource base and to upgrade inferred resources into the indicated category. Core drilling was not carried out in areas where the oxide mineralization is exposed on surface

due to the difficulty encountered in collaring within the loose material and subsequent very poor core recovery through the mineralized zone. As a consequence, much of this material is not included in the resource. To remedy this situation, a program of 950 m of trenching and channel sampling and 22 auger holes on 14 sections through the mineralized zone, from section 10+075 to 10+425, is recommended, at an estimated cost of \$70,000.

Recommended core drilling includes 9 shallow drill holes for a total of 490 m to provide better definition of Tiger Deposit mineralization at an estimated budget of \$269,500.

A summary of estimated costs to advance the Tiger Gold Project to a prefeasibility level is provided in Table 1-13 below.

Table 1-13
Summary of Estimated Costs for Next Level of Study (Prefeasibility)

Task	Cost
Metallurgical tests, scrubbing, CIL, column tests, thickener tests, work indexes, abrasion, rinsing, cyanide destruction	\$200,000
Designs & studies, plant	\$200,000
Designs & studies, infrastructure	\$200,000
Hydrology studies	\$75,000
Waste characterization	\$100,000
Geotechnical studies	\$50,000
Mining studies	\$150,000
Flora / fauna / heritage studies	\$100,000
Geochemical characterization	\$100,000
Management plan preparation	\$100,000
Closure plan preparation	\$100,000
Social agreements advance	\$100,000
Additional drilling	\$339,500
Total	\$1,814,500

2.0 INTRODUCTION

2.1 Introduction and Overview

This report documents:

- a previously reported mineral resource estimate;
- historical exploration work, description of the property, geology and nature of mineralization;
- new mining studies;
- new metallurgical studies;
- evaluations of processing options and plant throughput rates;
- investigations of site environmental status and regulatory requirements necessary for production;
- analysis of infrastructure and logistic strategies; and
- a preliminary economic model based upon the results of those studies, which considers treating only the oxide mineralization at the Tiger Deposit, Rau Property located in east central Yukon.

ATAC is listed on the TSX Venture Exchange (TSX-V: ATC) and holds a 100% interest in the Tiger Deposit resource.

This report was produced for the purpose of supplying updated information to the shareholders of ATAC as the Tiger Gold Project is being advanced within the Rackla Gold Belt. The report was written in compliance with disclosure and reporting requirements set forth in the Canadian Securities Administrations' current "Standards of Disclosure for Mineral Projects" under the provisions of National Instrument 43-101, Companion Policy 43-101 CP and Form 43-101F1.

The previously published resource estimate was completed by Gary Giroux, P.Eng., M.A.Sc. of Giroux Consultants Ltd., of Vancouver, BC. The resource estimate was prepared using drill data generated between 2008 and 2010. A Technical Report was issued November 15, 2011, by Protore Geological Services reporting oxide and sulfide mineral resources. The resource estimate has not been updated since that time with the exception of subdividing the block model to utilize smaller blocks for the purposes of mine optimization exercises, which had no material effect to previously published grade, mineralized material tonnes, waste, or contained ounces. The block model subdivision was performed by ATAC and verified by Gary Giroux, the original resource author.

The property description, including reporting on historical exploration work, geology and mineralization was produced by Gerald G. Carlson, Ph.D., P.Eng., of Vancouver, BC.

The new mining studies were conducted by Sabry Abdel Hafez, Ph.D., P.Eng., of Tetra Tech Inc., Vancouver, BC.

The new metallurgical work, processing studies, cost estimations, and financial analysis were conducted by Kappes, Cassiday & Associates under the auspices of Daniel Kappes, P.Eng., of Reno, NV.

Environmental review and assessment of regulatory requirements were performed by Robert L. McIntyre, R.E.T., Principal, Resource Strategies, Whitehorse and Vancouver, BC.

Mr. Giroux, Dr. Hafez, Mr. Kappes, Dr. Carlson, and Mr. McIntyre are qualified persons under National Instrument 43-101. There is no affiliation between Mr. Giroux, Dr. Hafez, Mr. Kappes, Dr. Carlson, Mr. McIntyre and ATAC Resources Ltd. except that of an independent consultant / client relationship.

The PEA is preliminary in nature. It includes inferred mineral resources that are considered too speculative geologically to have the economic considerations applied to them that would enable them to be categorized as mineral reserves, and as such there is no certainty that the project as outlined in the PEA will be realized.

The effective date of the mineral resource is 15 November 2011. The effective date of the PEA is 23 July 2014. The effective date of this report is 5 September 2014.

2.2 Project Scope and Terms of Reference

The purpose of this Technical Report is to provide a Preliminary Economic Analysis of a conceptual mining and processing project treating the oxide materials as detailed in the formal mineral resource estimate of the Tiger Deposit and by doing so satisfy the reporting requirements as described in the Canadian Securities Administration's current "Standards of Disclosure for Mineral Projects" under the provisions of National Instrument 43-101, Companion Policy 43-101 CP and Form 43-101F1.

The scope of this report includes a study of information obtained from public documents; assessment reports; other literature sources cited; results of geological work performed on the property; review of all metallurgical tests and programs conducted to date; cost information from public documents, fresh quotes, recent pricings, recent estimates from previous studies, and real construction projects conducted by KCA. Mining costs were estimated from equipment productivity calculations, and more generally from “Mine and Mill Equipment Costs – An Estimators Guide 2013”. The annual equipment utilization hours were derived from calculated available hours less estimated operating delays, and then applied to the hourly equipment costs to calculate direct mining operating costs.

The Senior Author, Daniel Kappes, P.Eng., visited the property on August 27, 2013, examined core from both the oxide and sulfide portions of the Tiger Deposit, met with the exploration crew, walked portions of the Tiger Deposit mineralized outcrop, and over flew the Rau trend hosting the Tiger Deposit mineralization, as well as proposed plant and infrastructure sites.

Sabry Abdel Hafez, Ph.D., P.Eng., visited the property on November 15, 2013 and toured the open pit, waste dump, haul road, access and other proposed infrastructure sites.

Gary Giroux, P.Eng., visited the property on September 7-9, 2009 and August 30-31, 2011, examined core from both the oxide and sulfide portions of the Tiger Deposit, met with the exploration crew and over flew the Rau trend hosting the Tiger Deposit mineralization.

Gerald Carlson, Ph.D., P.Eng., visited the property on September 4, 2008, examined core from the oxide and sulfide portions of the Tiger Deposit, met with exploration crew, and toured the deposit area.

Table 2-1 shows the responsible party for each section.

Table 2-1
Table of Responsibilities by Section

Section	Section Title	QP
1	Summary	All
2	Introduction	D. Kappes
3	Reliance on Other Experts	D. Kappes
4	Property Description and Location	G. Carlson
5	Accessibility, Climate, Local Resources, Infrastructure and Physiography	G. Carlson
6	History	G. Carlson
7	Geological Setting and Mineralization	G. Carlson
8	Deposit Types	G. Carlson
9	Exploration	G. Carlson
10	Drilling	G. Carlson
11	Sample Preparation, Analyses and Security	G. Carlson
12	Data Verification	G. Carlson
13	Mineral Processing and Metallurgical Testing	D. Kappes
14	Mineral Resource Estimates	G. Giroux
15	Mineral Reserve Estimates	S. Hafez
16	Mining Methods	S. Hafez
17	Recovery Methods	D. Kappes
18	Project Infrastructure	D. Kappes
19	Market Studies and Contracts	D. Kappes
20	Environmental Studies, Permitting and Social or Community Impact	R. McIntyre
21	Capital and Operating Costs	Kappes / Hafez
22	Economic Analyses	D. Kappes
23	Adjacent Properties	G. Carlson
24	Other Relevant Data and Information	All
25	Interpretation and Conclusions	Kappes / Hafez
26	Recommendations	All
27	References	All

2.3 Frequently Used Acronyms, Abbreviations, Definitions, and Units of Measure

All costs are in Canadian dollars unless indicated otherwise. Units of measurement are metric. Only common and standard abbreviations were used wherever possible. A list of abbreviations used is as follows:

Distances:	mm	– millimeter
	cm	– centimeter
	m	– meter
	km	– kilometer
	µm	– micrometers
	mbgl	– meters below ground level
Areas:	m ² or sqm	– square meter
	ha	– hectare

	km ²	– square kilometer
Weights:	oz	– troy ounces
	koz	– 1,000 troy ounces
	g	– grams
	kg	– kilograms
	T or t	– metric tonne (1000 kg)
	Kt	– 1,000 tonnes
	Mt	– 1,000,000 tonnes
Time:	min	– minute
	h or hr	– hour
	op hr	– operating hour
	d	– day
	mo	– month
	a	– annum
	Ma	– Mega-annum (one million years)
Volume/Flow:	m ³ or cu m	– cubic meter
	m ³ /h	– cubic meters per hour
	L/s	– liters per second
	L/h	– liters per hour
Assay/Grade:	g/t	– grams per tonne
	g Au/t	– grams gold per tonne
	g Ag/t	– grams silver per tonne
	ppm	– parts per million
	ppb	– parts per billion
	oz/t	– troy ounces per ton
Other:	TPD or t/d	– metric tonnes per day
	m ³ /h/m ²	– cubic meters per hour per square meter
	L/h/m ²	– liters per hour per square meter
	L/s/km ²	– liters per second per square kilometers
	g/L	– grams per liter
	Ag	– silver
	Au	– gold
	AuEq	– gold equivalent
	Cu	– copper
	Hg	– mercury
	US\$ or USD	– United States Dollar
	CAD or \$	– Canadian Dollar
	NaCN	– sodium cyanide
TSS	– total suspended solids	

TDS	– total dissolved solids
DDH	– diamond drill boreholes
LOM	– life of mine
kWh	– kilowatt-hours
mg/L	– milligrams per liter
P80	– 80% passing

3.0 RELIANCE ON OTHER EXPERTS

The Authors are not experts in legal matters, such as the assessment of the legal validity of mining claims or concessions; private lands, mineral rights, and property agreements.

The Authors rely on information provided by ATAC as to the title of the property comprising the Tiger Gold Project, the terms of property agreements, and the existence of applicable royalty obligations.

Data presented in Section 4 concerning the location and status of mineral claims was provided by ATAC and presented in the previously published NI 43-101 Technical Report, dated November 15, 2011. The Authors assume that independent legal advice has been received by ATAC regarding the validity of the claims.

The Authors have also relied on ATAC and their financial staff to determine appropriate tax implications in the financial analysis for the PEA. The Authors are not experts on Canadian tax issues.

4.0 PROPERTY DESCRIPTION AND LOCATION

The Tiger occurrence, a part of the Rau Property, is centered at 64.193488° N latitude and -134.437926° W longitude in central Yukon and consists of 2,798 contiguous quartz mineral claims on NTS map sheets 106D/01, 106D/02, 106D/06, 106D/07 & 106D/08 (Figure 4-1, the “Property”). The Property covers an area of 57,671 hectares (576.7 km²). The claims are registered with the Mayo Mining Recorder in the name of Archer, Cathro and Associates (1981) Limited (“Archer Cathro”), holding them in trust for ATAC. ATAC owns the Property 100%, with no underlying interests. The claims and expiry dates as of 2 June 2014, are tabulated in Table 4-1 and the claim locations are shown on Figure 4-2.

ATAC RESOURCES LTD.

ARCHER, CATHRO & ASSOCIATES (1981) LIMITED

FIGURE 4-1

PROJECT LOCATION

RAU PROPERTY

0 200 km

FILE:2014/RAU

DATE: JUNE 2014

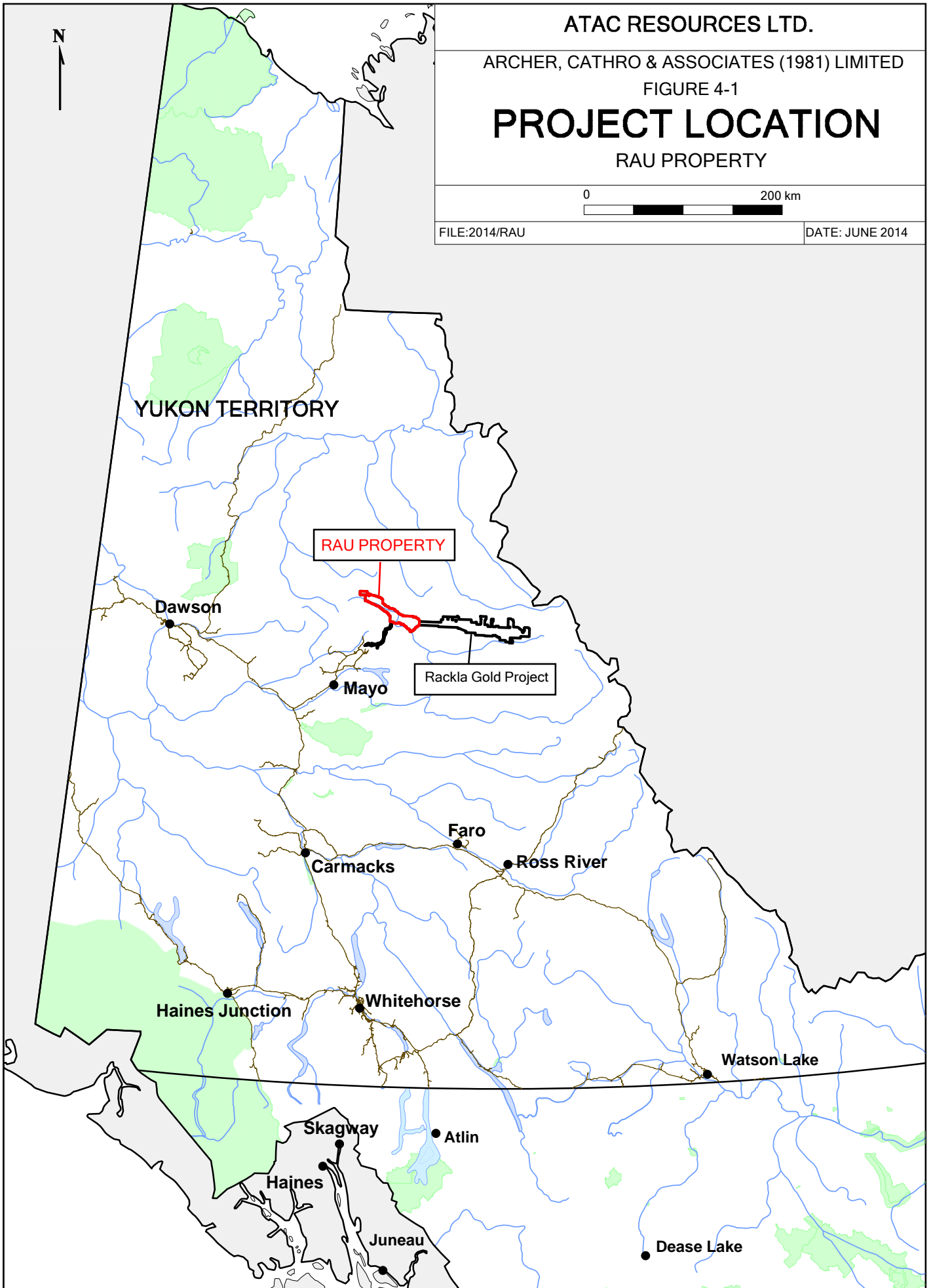

Table 4-1
Claim Data

<u>Claim Name</u>	<u>Grant Number</u>	<u>Expiry Date</u>
GF 3-4	YC32305-YC32306	April 28, 2029
Q 1-13	YC92361-YC92373	April 28, 2026
Q 14	YC92470	April 28, 2026
Q 15-109	YC92375-YC92469	April 28, 2026
R 1-103	YC68334-YC68436	April 28, 2028
R 105-1295	YC68438-YC69628	April 28, 2028
R 1296-1337	YC70595-YC70636	April 28, 2025
Rau 1-64	YC50268-YC50331	April 28, 2035
Rau 65-96	YC57529-YC57560	April 28, 2028
Rau 97F-98F	YC69925-YC69926	April 28, 2029
Rau 99F-100F	YC69961-YC69962	April 28, 2029
S 1-700	YC90801-YC91500	April 28, 2026
S 701-842	YC91901-YC92042	April 28, 2026
S 843	YC92355	April 28, 2026
S 844-1154	YC92044-YC92354	April 28, 2024
S 1155-1244	YD09635-YD09724	March 1, 2019
S 1245-1246	YD09725-YD09726	March 1, 2021
S 1247	YD09727	March 1, 2019
S 1248	YD09728	March 1, 2021
S 1249-1250	YD09729-YD09730	March 1, 2019



RAU PROJECT BOUNDARY

RACKLA GOLD PROPERTY BOUNDARY

The mineral claims comprising the Property can be maintained in good standing by performing approved exploration work to a dollar value of \$100 per claim per year. The Author is not aware of any encumbrances associated with lands underlain by the Property.

The claim posts on the Property have been located by GPS using the UTM coordinate system (R. Carne, pers. com., 2014).

4.1 Location of Mineralization

The gold mineralization that comprises the Tiger Zone, the main focus of this Technical Report, is located on quartz mineral claims Rau 56 and 97F. The Tiger Zone and other known mineral occurrences documented within the Property are shown on Figure 4-3.

ATAC RESOURCES LTD.

ARCHER, CATHRO & ASSOCIATES (1981) LIMITED
FIGURE 4-3

MINERALIZATION AND OCCURENCES

RAU PROPERTY

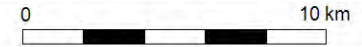

FILE:2014\RAU

DATE: JUNE 2014

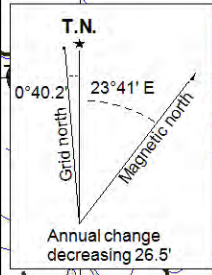
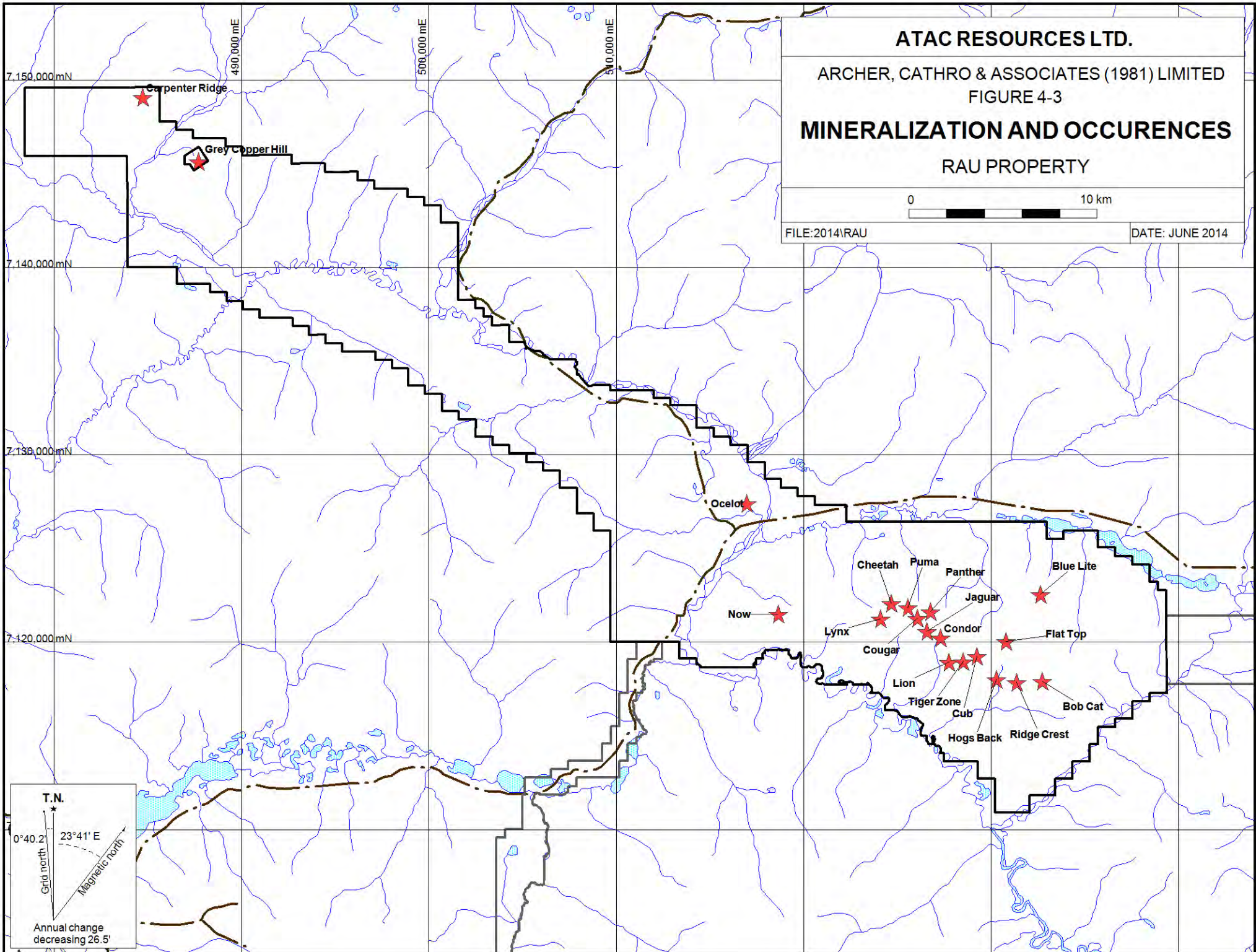

5.0 ACCESSIBILITY, CLIMATE, LOCAL RESOURCES, INFRASTRUCTURE AND PHYSIOGRAPHY

The Property lies 100 km northeast of Mayo, the nearest supply center. The closest road access is to the community of Keno City, situated 49 km by road northeast of Mayo and 55 km by air southwest of the Property. Mayo and Keno City can be reached in all seasons by two wheel drive vehicles using the Yukon highway system from Whitehorse, Yukon. The Wind River Trail, classified as a “winter road”, starts at McQuesten Lake near Keno City and crosses the central portion of the Property. The Wind River Trail has been used intermittently by various exploration companies since it was built in the late 1960’s and most recently in 2007 as a winter fuel route into the Wernecke Mountains.

From Whitehorse there is daily jet service to Vancouver, British Columbia and other points south. Whitehorse is a major center of supplies, communications and a source of skilled labor for exploration diamond drilling, construction and mining operations. Portable electrical generators provide sufficient power for exploration stage programs and the creeks in the area provide sufficient water for camp and diamond drilling requirements on the Property. The Property area contains abundant accessible sites for mining, camp sites, potential heap leach and tailings storage areas, waste disposal areas and potential processing plant sites with no conflicting surface rights.

For exploration programs on the Property, access from Keno City or Mayo is by helicopter based in Mayo and operated by Fireweed Helicopters Ltd. or Trans North Helicopters Ltd., both of Whitehorse. Fixed wing access is available to ATAC’s airstrip along the southeastern boundary of the Property (Figure 4-3). A local trail system, constructed in 2009 using a John Deere 450 bulldozer, provided access for the core drilling program in the valley containing the Tiger Deposit. The trail system is accessible with the use of a four wheel drive ATV from the exploration camp to the main drill area.

The Property is 66 km long and covers a diverse geomorphological setting. Much of the claim block covers low lying vegetated valley bottom and similarly covered low elevation ridge systems.

The majority of the Property is situated within the Nadaleen Range of the Selwyn Mountains and is drained by creeks that flow into the Rackla and Beaver Rivers, which are both part of the Yukon River watershed. Local topography is alpine to sub-alpine and features north and south-trending rocky spurs and valleys that flank a main east-west

trending ridge. Elevations range from 725 meters along the Beaver River in the center of the Property to 1,800 meters atop a peak that is referred to as Monument Hill. Outcrop is most abundant on or near ridge crests and in actively eroding creek beds. Most hillsides are talus covered at higher elevations and are blanketed by glacial till at lower elevations. Soil development is moderate to poor in most areas.

Valley floors are well treed with mature black spruce. The density and size of vegetation gradually decreases with increasing elevation. Undergrowth typically consists of low shrubs and moss. Tree line in the vicinity of the Property is at about 1,500 meters. Slopes above that elevation are un-vegetated with the exception of moss and lichen. South facing slopes are typically well drained and are often lightly forested with poplar. Steep, north facing slopes are usually rocky outcrop and talus. Gentler, spruce- and moss-covered terrain, mainly north-facing, exhibits widespread permafrost.

Much of the overburden in the region is associated with the most recent Cordilleran ice sheet, the McConnell glaciation, that is believed to have covered south and central Yukon between 26,500 and 10,000 years ago.

The climate at the Rau Property is typical of northern continental regions with long, cold winters, short fall and spring seasons and mild summers. Snowfall can occur in any month at higher elevations. The Property is mostly snow free from early June to late September, coinciding with the exploration season. According to Environment Canada, Mayo holds the Yukon high-temperature record based on June 14, 1969, when the thermometer peaked at 36.1° C. The lowest temperature in Mayo, recorded on 3 February 1947, is minus 62.2° C. Mayo holds the Canadian record for the greatest range of absolute temperatures, a difference of 98.3 degrees Celsius between the extreme high and extreme low (Yukon Community Profiles, 2011).

Historical weather records over the past three decades show that the average daytime temperature in January in Mayo is minus 20.5° C, dropping to minus 31° C at night. In July the daytime average is close to plus 23° C while the nighttime temperature drops to about 9° C. Annual precipitation averages 313 mm, as 205 mm of rain and 147 cm of snow.

6.0 HISTORY

The locations referred to in this section are shown on Figure 4-3 while the various surveys conducted by ATAC between 2006 and 2013 are shown on Figures 6-1 through 6-3.

ATAC RESOURCES LTD.

ARCHER, CATHRO & ASSOCIATES (1981) LIMITED

FIGURE 6-1

HISTORICAL GRID AND CONTOUR SOIL SAMPLING

RAU PROPERTY

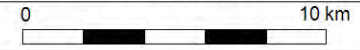

FILE:2014\RAU

DATE: JUNE 2014















7,150,000 mN

490,000 mE

500,000 mE

510,000 mE

7,140,000 mN

-  2007 soil grid
-  2008 silt
-  2008 soil grid
-  2009 contour soils
-  2009 soil grid
-  2010 silt
-  2010 contour soils
-  2010 soil grid
-  2011 contour soils
-  2011 soil grid
-  2012 contour soils
-  2012 soil grid
-  2013 contour soils
-  2013 soil grid

Ocelot

Tiger Deposit

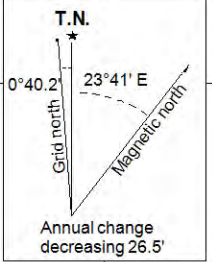

ATAC RESOURCES LTD.

ARCHER, CATHRO & ASSOCIATES (1981) LIMITED
FIGURE 6-2

HISTORICAL GEOPHYSICAL SURVEYS



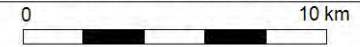



RAU PROPERTY

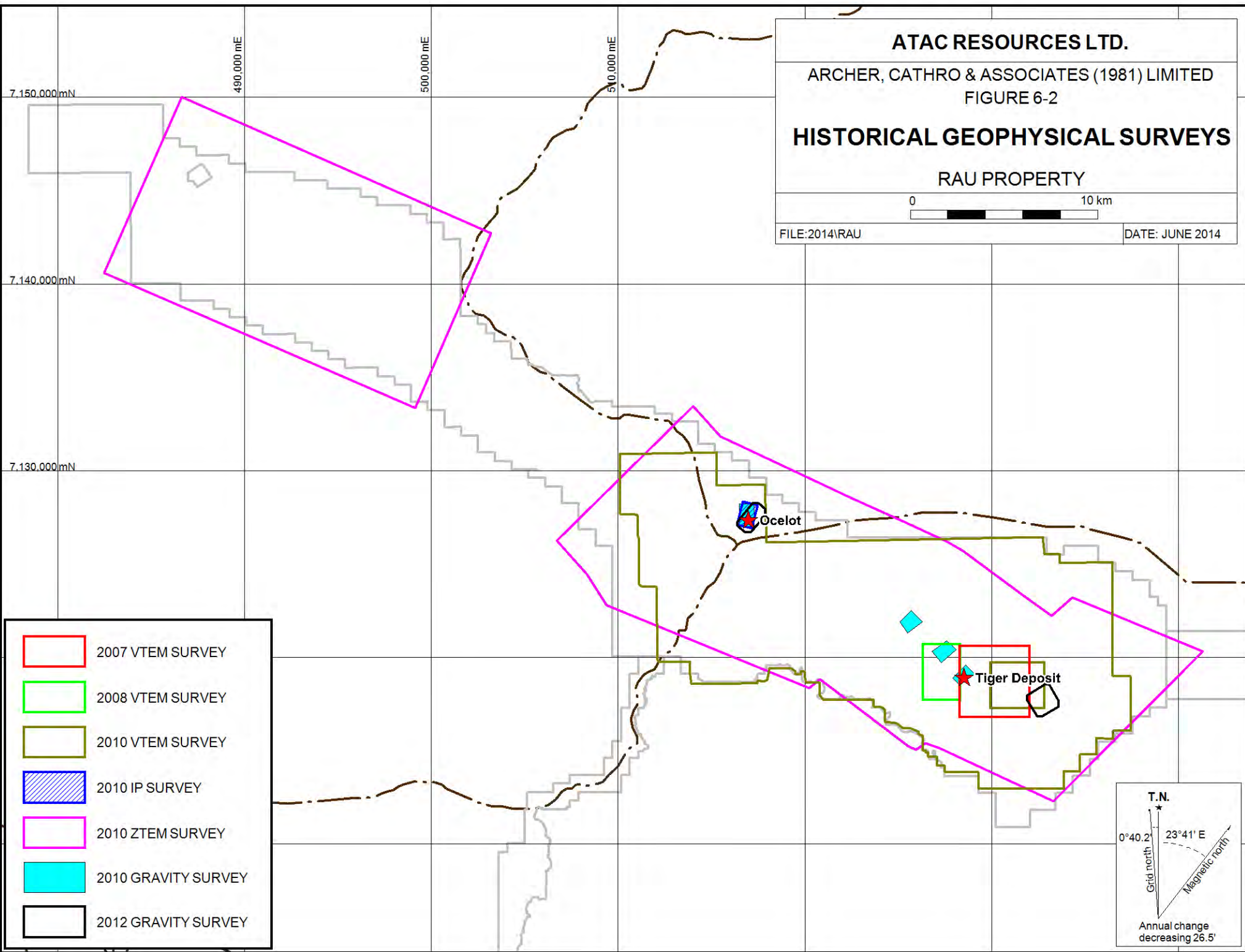

FILE:2014\RAU

DATE: JUNE 2014



-  2007 VTEM SURVEY
-  2008 VTEM SURVEY
-  2010 VTEM SURVEY
-  2010 IP SURVEY
-  2010 ZTEM SURVEY
-  2010 GRAVITY SURVEY
-  2012 GRAVITY SURVEY

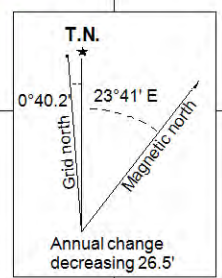



510,000mE

515,000mE

520,000mE

7,130,000mN

7,125,000mN

7,120,000mN

ATAC RESOURCES LTD.

ARCHER, CATHRO & ASSOCIATES (1981) LIMITED
FIGURE 6-3

HISTORICAL DIAMOND DRILLING

RAU PROPERTY

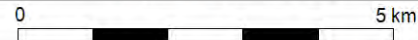

FILE:2014\RAU

DATE: JUNE 2014

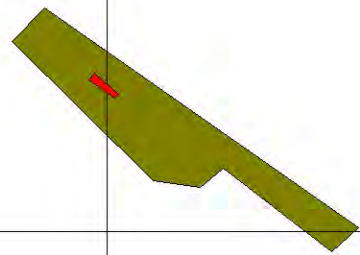

INSET

AREA OF INTEREST

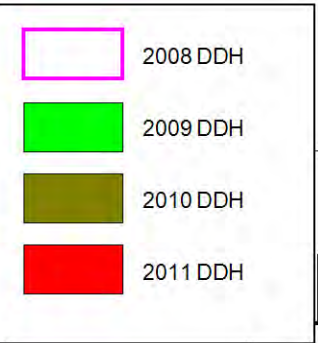

The earliest reported exploration within the area occurred in 1922 following the discovery of silver mineralization at Keno Hill, when prospectors first identified and staked mineralized float occurrences at Carpenter Ridge north of the far northwest corner of the Property. In 1924, reconnaissance work conducted by the Geological Survey of Canada discovered galena-calcite-siderite float on the southwest end of Carpenter Ridge. A sample of this float assayed 8.75 oz/t silver and 56.0% lead (Cockfield, 1925). However, the source of this mineralization was not found. Hand pits were dug in 1927 and 1928 but little record remains of the work completed during this period. All claims were ultimately dropped.

At Grey Copper Hill, 9 km to the southeast, silver-rich tetrahedrite float was discovered in 1923 by an independent prospector. This showing and other nearby prospects were staked later that year. Several exploration adits were dug into the hillside during unsuccessful follow up exploration and eventually all claim holdings lapsed.

Between 1930 and 1974 Grey Copper Hill was staked several times by independent prospectors and exploration companies, including Cypress Resources Limited and United Keno Hill Mines Limited. Little work was reported (Hilker, 1969) and all claims ultimately expired.

Hesca Resources Corporation Ltd. (“Hesca”) staked Grey Copper Hill in 1974 and conducted prospecting, soil sampling, hand trenching and adit maintenance. In addition, two shallow, small diameter diamond drill holes totaling 56.3 meters were drilled; however, the results from this drilling are not documented. No further work was done by Hesca and the claims were dropped (Deklerk and Traynor, 2004).

In 1978, Prism Resources Limited staked the Grey Copper Hill area and conducted prospecting and geochemical sampling. Soil sampling identified several lead and silver anomalies. Follow up prospecting failed to explain them (Sivertz, 1979). A sample collected from an outcrop of dolomite yielded 0.60% lead and 51.43 g/t silver, while a tetrahedrite sample collected near an old adit assayed 7,000 g/t silver (Sivertz, 1980). The Prism Joint Venture allowed the claims to lapse.

Grey Copper Hill was again staked in 1983 by a prospector who conducted grid soil sampling later that year. This program delineated silver anomalies coincident with surface lineaments. No further work was completed and the claims expired.

In 1988 Bonventures Limited staked the area and conducted limited blast trenching, prospecting, mapping plus soil and rock sampling. A gossan zone with pyrite and strong

fracture filling malachite and azurite was identified between two collapsed adits (Carlyle, 1989). These claims eventually lapsed.

The area remained open until August of 2005 when an independent prospector staked four claims over the Grey Copper Hill showing. No work on these claims has been reported and they are now surrounded by the Property.

In the east-central part of the Property, Cominco Limited (“Cominco”) staked the Beaver claims in 1968 based on results of regional geochemical sampling done the year before. Later that year, L. Elliott staked the nearby Now claims and optioned them to Cominco, who completed mapping and soil sampling in 1968 and 1969 (Johnson and Richardson, 1969a and b).

In 1977, the Prism Joint Venture (Asamera Oil Corp, Chieftain Development Company Limited, Prism Resources Ltd, Siebens Oil & Gas Limited and E & B Exploration Limited) staked the area of the Cominco claims as part of a larger block that extended for about 20 km along the north side of the Beaver River. In 1979, Dome Petroleum Ltd. replaced Siebens in the joint venture.

The Prism Joint Venture conducted most of its activities around the original Beaver claims. Soil sampling and mapping were performed in 1977 (Montgomery and Dewonck, 1978) and additional soil sampling and trenching were done in 1978 (Prism Joint Venture, 1979a). In 1979 the Prism Joint Venture completed six diamond drill holes that totaled 610 meters (Dewonck, 1980). This work focused primarily on sedimentary exhalative and Mississippi Valley type lead-zinc mineralization, but resulted in the discovery of a narrow gold-rich vein (the Now Showing).

NDU Resources Ltd. (“NDU”) staked claims over the Now Showing in 1987 to cover the lead, zinc and silver soil geochemical anomalies identified by Cominco and the Prism Joint Venture. The following year, NDU conducted a geochemical sampling program that focused on the gold vein mineralization at the Now Showing (Cathro, 1989).

In 1977, 6.25 km further to the northwest, the Prism Joint Venture conducted mapping, soil sampling and electromagnetic surveys. Numerous samples from that program returned high zinc soil values ranging from 2,100 ppm to 12.2%. One sample collected from a large transported gossan (Ocelot Showing) yielded 3.8 g/t silver, 800 ppm lead and 12.2% zinc (Montgomery and Cavey, 1978), suggesting the metals were leached and remobilized in acidic groundwater before being re-precipitated when the fluids were neutralized. These results were not followed up. In 1977, the Prism Joint Venture also

performed minor soil sampling near a strong gossan developed along the eastern edge of the Property (Kathy Showing) (Prism Joint Venture, 1979b).

In 1979 and 1980, the Prism Joint Venture explored in two areas in the north central part of the Property and conducted prospecting, soil geochemical sampling and drilled one core hole. This work led to the discovery of scheelite mineralization at the Blue Lite and Flat Top Showings. Tremolite skarn specimens from the Flat Top Showing assayed 8.4% WO₃, but most material graded below 0.04% (Churchill, 1980). No further work was done at either showing.

ATAC became interested in the location of an isolated, high gold value (150 ppb) reported by a regional-scale stream sediment geochemical survey, conducted by the Geological Survey of Canada (Hornbrook, et al 1990). This value is in the 99th percentile of gold results from the survey and is supported by a 99th percentile tungsten value (25 ppm). The sample was collected near the Rackla Pluton, east of the Tiger Deposit.

In summer 2006, ATAC staked 64 claims to cover the anomalous drainage. During the staking, a number of rock and soil samples were collected, many of which returned anomalous values for tungsten and a few were notably enriched in gold, lead, zinc, silver and copper. Cursory prospecting located scheelite-bearing tremolite skarn (Flat Top Showing) and discovered tungsten in diopside-actinolite skarn and highly fractionated intrusive rocks, about 1,500 meters to the south.

In 2007, ATAC completed geological mapping, prospecting, grid soil sampling and helicopter-borne variable time-domain electromagnetic (VTEM) surveys (Eaton and Panton, 2008). This work partially delineated a large hydrothermal system centered on the largely buried Rackla Pluton. Following that program, ATAC staked an additional 32 claims, mostly to improve coverage around a very strong gold-in-soil anomaly outlined on the western edge of the grid.

ATAC and Yankee Hat Minerals Limited signed an option agreement in spring 2008 concerning 40 claims that covered the Rackla Pluton and the tungsten-bearing skarns. During the summer of 2008 Yankee Hat conducted prospecting and a total of 437.4 meters of diamond drilling in three holes (Dumala, 2008). Several narrow skarn bands with weak to moderate tungsten mineralization were identified within the carbonate host rocks. The option agreement was terminated in late 2008 following poor results and the claims were returned to ATAC.

Also in the summer of 2008, ATAC conducted geological mapping, prospecting, soil and stream sediment geochemical sampling, 3,423.2 meters of diamond drilling in 18 holes and Property-wide helicopter-borne magnetic variable time-domain electromagnetic (VTEM) surveys on the claims not covered by the Yankee Hat option agreement. Drilling identified three stacked, gold-bearing horizons in what is now known as the Tiger Deposit. The central horizon (Discovery Horizon) contains gold in iron carbonate replacement and hosts the most abundant mineralization. In 2008, grid soil sampling and stream sediment sampling was extended to the northwest. Property wide geophysical and geochemical surveys completed later in the season suggested the trend extends for as much as 22 km (Dumala, 2009). In response to positive results, ATAC added 1,340 claims to cover the favorable stratigraphy along the anomalous trend.

In 2009, ATAC continued to delineate the Tiger Deposit with an additional 58 diamond drill holes that totaled 9,578.3 meters (Dumala and Lane, 2010). Drilling identified a significant oxide component to the northwest, within the Tiger Deposit. Prospecting in 2009 also identified several new showings containing mineralization similar to that found at the Tiger Deposit. These include the Cub, Lion, Jaguar, Panther, Cougar, Puma, Cheetah and Lynx Showings.

ATAC continued its exploration campaign in 2010 with regional scale silt and contour soil sampling, localized grid soil sampling, an airborne Z Axis Tipper Electromagnetic (“ZTEM”) survey, continued prospecting and mapping, ground gravity surveys and 18,450.4 meters of diamond drilling. The majority of the diamond drilling was focused within the Tiger Deposit for the purpose of resource definition but a number of peripheral targets were also tested based on combinations of positive geological, geochemical and geophysical response. Results of ATAC’s exploration programs conducted between 2007 and 2010 are summarized in Stroshein et.al. (2011).

No work was conducted on the Tiger Deposit in 2011. ATAC drilled 3,784.6 meters at the Ocelot Zone lead-zinc-silver discovery in 2011.

In 2012 and 2013, ATAC carried out reconnaissance exploration on the Property, resulting in a new gold discovery called the Bengal Zone (R. Carne, pers. com., 2014).

Late in 2013, ATAC collected a 975 kg bulk sample of oxide mineralization from the Tiger Deposit using a six inch diameter auger drill. The sample was shipped to KCA in Reno, NV, for metallurgical sampling over the winter of 2013-14. Limited auger drilling was also carried out at proposed tailings pond and leach pad sites for the purpose of geotechnical data collection.

7.0 GEOLOGICAL SETTING AND MINERALIZATION

The following italicized portions of section 7.0 of this report, **GEOLOGICAL SETTING AND MINERALIZATION**, are taken from verbatim from Stroshein (Protore Geological Services) et.al. from the previously published NI 43-101 Technical Report, dated November 15, 2011. Minor updating of this text by the Author (Carlson) is not italicized. Figures (photos of core) have been omitted from this presentation of the previously published report.

7.1 Regional Geology

The Geological Survey of Canada performed geological mapping in the vicinity of the Rau Property at 1:250 000 scale in the 1960s (Green, 1972) and 1970s (Blusson, 1978). More recent mapping in the area was completed at 1:50 000 scale by Indian and Northern Affairs Canada (Abbott, 1990 and Roots, 1990).

The Rau Property lies within a band of regional-scale thrust and high angle reverse faults that imbricate rocks of Selwyn Basin and Mackenzie Platform (Figure 7-1). Selwyn Basin stratigraphy consists of regionally metamorphosed, basinal sediments of Neoproterozoic to Paleozoic age. Mackenzie Platform stratigraphy comprises dominantly shallow water carbonate and clastic sediments that were deposited from Mid-Proterozoic through Paleozoic times. Both packages of sediments were deposited on the western margin of ancestral North America.

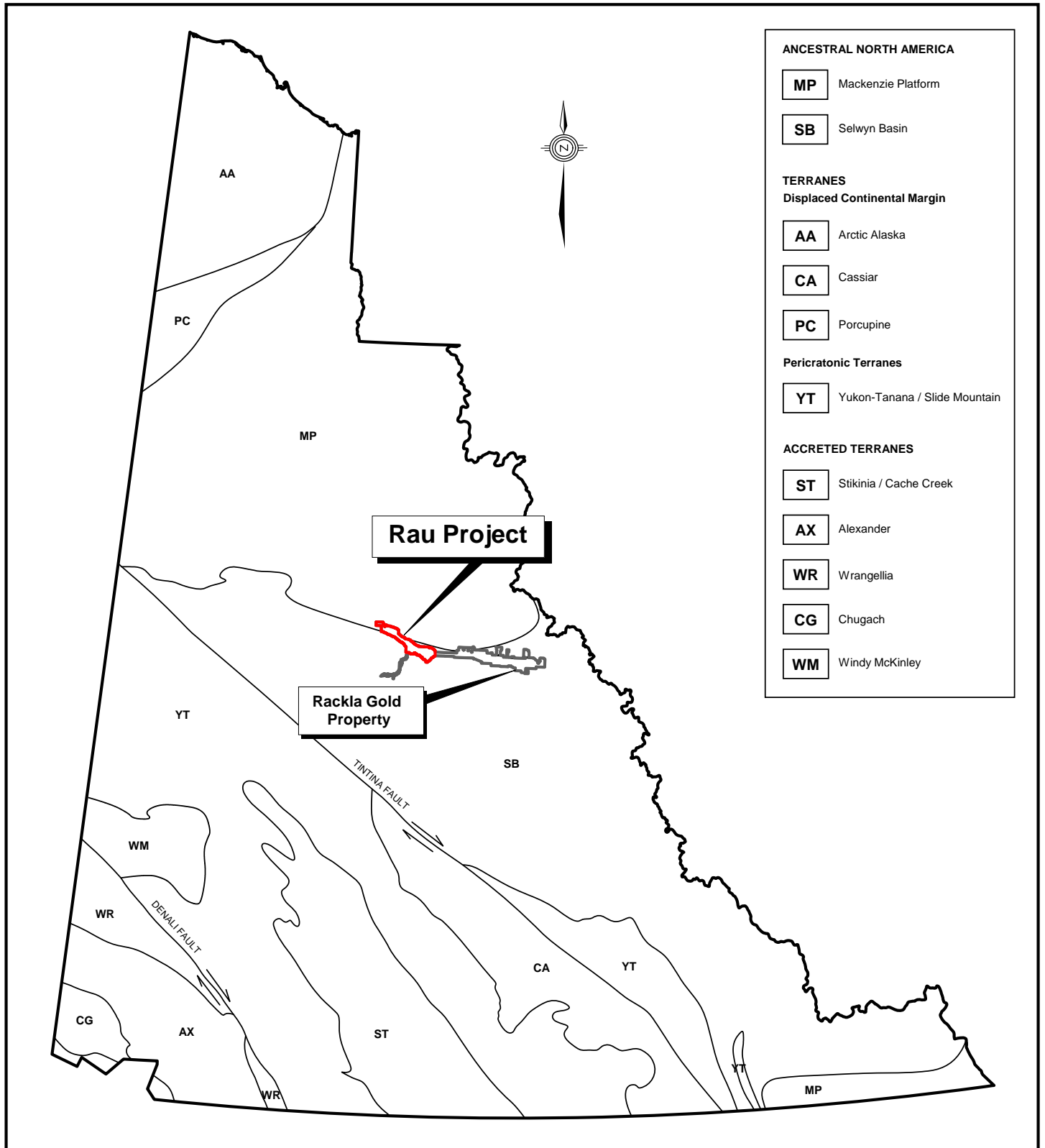

- ANCESTRAL NORTH AMERICA**
- MP** Mackenzie Platform
 - SB** Selwyn Basin
- TERRANES**
- Displaced Continental Margin**
- AA** Arctic Alaska
 - CA** Cassiar
 - PC** Porcupine
- Pericratonic Terranes**
- YT** Yukon-Tanana / Slide Mountain
- ACCRETED TERRANES**
- ST** Stikinia / Cache Creek
 - AX** Alexander
 - WR** Wrangellia
 - CG** Chugach
 - WM** Windy McKinley



ATAC RESOURCES LTD.

ARCHER, CATHRO & ASSOCIATES (1981) LIMITED
FIGURE 7-1

TECTONIC SETTING
RAU PROPERTY





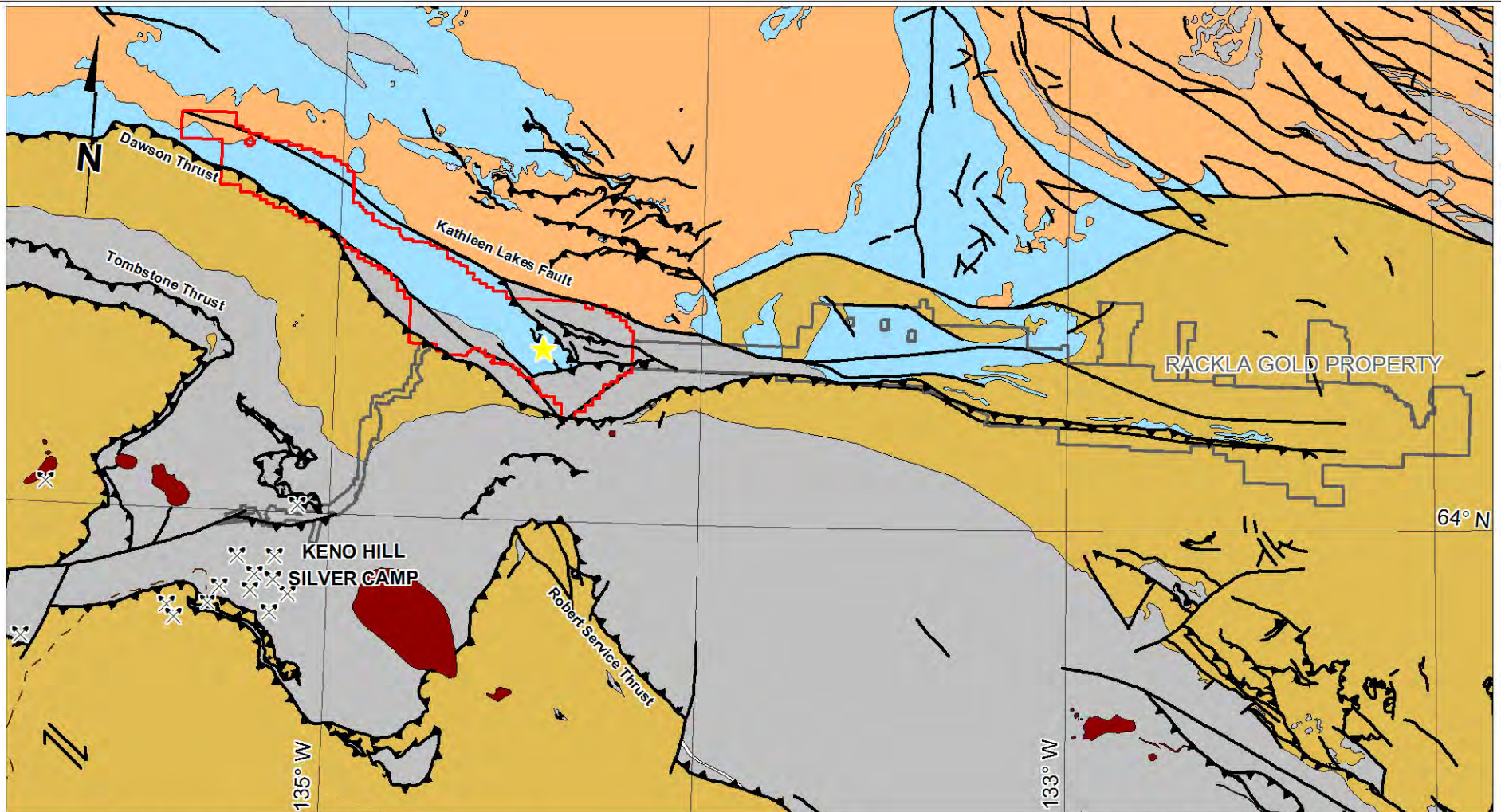

0 200 km

FILE: ...2014\RAU DATE: JUNE 2014

The thrust faults were active during Jurassic to Cretaceous times (160 to 130 Ma), when the area underwent compressional orogenesis related to large-scale plate convergence (Fingler, 2005). During Late Cretaceous (94-90 Ma), intermediate to felsic plutons of the Tombstone Suite were emplaced (Mortensen et al, 2000). Another compressional orogenic event that occurred about 65 Ma, was accompanied by emplacement of felsic intrusions assigned to the McQuesten Suite.

Figure 7-2 shows regional geology in central Yukon. It is a geological compilation that takes into account recent age dating and new unit correlations that Dr. Charlie Roots prepared for the Yukon Geological Survey (Cathro, 2006).



- | | |
|---|--|
|  Tombstone Suite Intrusions |  Former mine |
|  Earn Group |  High angle fault |
|  Bouvette Formation |  Thrust fault |
|  Hyland Group |  Major transcurrent fault |
|  Proterozoic Sediments |  Road |
| |  Tiger Zone |

Modified from: Gordey and Makepeace (2001)

ATAC RESOURCES LTD.

ARCHER, CATHRO & ASSOCIATES (1981) LIMITED

FIGURE 7-2

REGIONAL GEOLOGY

RAU PROPERTY



FILE: 2014\RAU	DATE: JUNE 2014
----------------	-----------------

The Tombstone, Dawson and Robert Service thrust faults plus a number of lesser thrust faults affect stratigraphy along the trend of the Rau claim block. All thrusts verge northeasterly and predate emplacement of the Tombstone Suite intrusions. The thrust panel that contains the Rau Property approximately straddles the boundary between Selwyn Basin and Mackenzie Platform and includes units belonging to both tectonic elements.

Table 7-1 contains a brief summary of the rock units in the area of the Rau Property.

Table 7-1
Regional Lithological Units (after Roots in Cathro, 2006)

<u>Tectonic Element</u>	<u>Age (Ma)</u>	<u>Unit and Lithologies</u>
<u>Rocks of Ancestral North America</u>		
Mackenzie Platform	1700 - 1800	Gillespie Lake Group: orange-brown dolostone and sandstone.
Mackenzie Platform	540 - 390	Bouvette Formation: white and grey limestone with rare black shale.
Mackenzie Platform	540 - 420	Marmot Formation: dark green to brown mafic, vesicular and amygdaloidal volcanic flows.
Selwyn Basin	750? - 530	Hyland Group: brown quartz-mica schist, with rare limestone.
Selwyn Basin	530 - 500	Gull Lake Formation: brown and green shale, sandstone, conglomerate and volcanic tuff.
Selwyn Basin	500 - 480	Rabbitkettle Formation: dark silty limestone and limy mica-rich conglomerate.
Selwyn Basin	480 - 390	Road River Group: black shale, chert and limy siltstone.
<u>Rock formed before orogenic event</u>		
	390 - 350	Earn Group: black shale and chert with lesser pebble conglomerate, sandstone and grit.
	340	Keno Hill Quartzite: grey metamorphosed sandstone, minor black shale and phyllite.
<u>Rocks formed during orogenic event</u>		

225	<i>Galena Suite intrusions: brown and green diorite and gabbro.</i>
200 - 250	<i>Jones Lake and Mt. Christie Formations: sandstone, brown shale and dark limestone.</i>

Rocks formed after orogenic event

90 - 94	<i>Tombstone Suite intrusions: granite and granodiorite.</i>
62 - 67	<i>McQuesten Suite intrusions: granite with two types of mica.</i>

Sediments younger than 3 Ma

0 - 3	<i>Overburden: ice-deposited sand and gravel; river silt.</i>
-------	---

7.2 Property Geology

Very little detail geological mapping has been conducted within the Property boundary, except within the vicinity of the Tiger Deposit. Most work has focused within the favorable Bouvette Formation stratigraphy in close proximity to the Tiger Deposit mineralization. The following descriptions are taken largely from previously documented government and historical mapping.

The Rau Property lies within a northwest trending thrust package bound to the south by the Dawson Thrust and to the north by the Kathleen Lakes Fault (Figure 7-3). Stratigraphy within this package forms open folds that are aligned parallel to the thrusts and plunge gently to the southeast. Several high angle faults that parallel the general structural trend are inferred on the Property and others could be present. One or more of these faults may have acted as a conduit for mineralizing fluids.

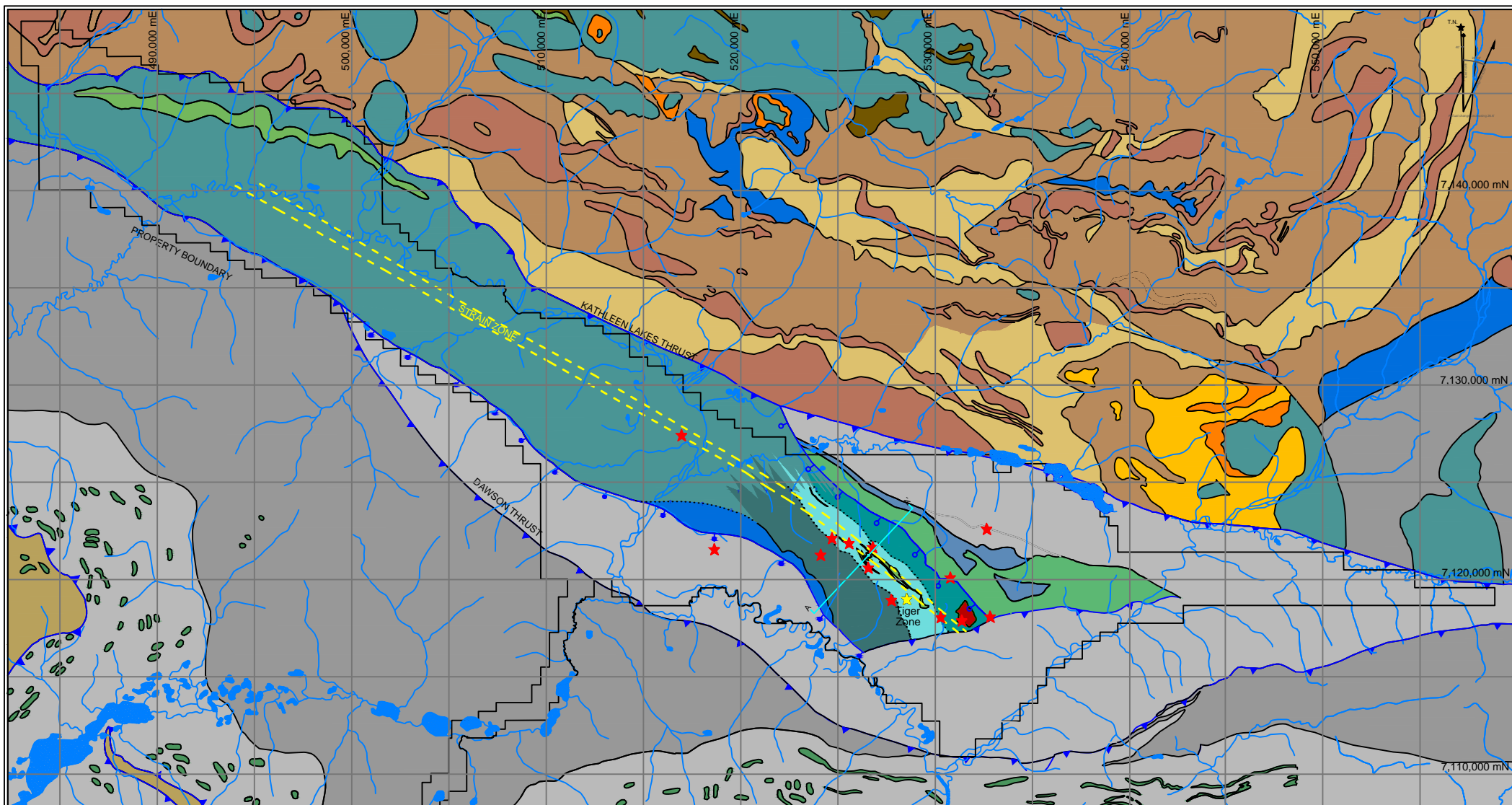

- Lower Paleogene**
- Rackla Pluton: granite with two types of mica.
- Triassic**
- TPG Galena Suite: brown and green diorite and gabbro.
- Carboniferous to Permian**
- CPps Skolai Group: dark grey slate interbedded with laminated quartz sandstone and thick bedded massive, fine grained quartzite; buff and green phyllite.
- Carboniferous to Permian**
- CPI Icefield Ranges Suite: thick bedded, buff and grey weathering, dark grey limestone.
- Mississippian**
- MK Keno Hill Quartzite: grey metamorphosed sandstone, minor black shale and phyllite.
- Devonian and Mississippian**
- DME Earn Group: black shale and chert with lesser pebble conglomerate, sandstone and grit.
- Devonian**
- DG Gossage Formation: limestone and dolostone with lesser black limestone and shale.

- Upper Cambrian to Lower Devonian**
- CDB Bouvette Formation: white and grey limestone with rare black shale.
 - CSc Cambrian to Devonian: massive pale grey dolostone, oncologic dolostone, minor quartzite, sandy dolostone.
 - OSc Ordovician to Silurian: thin to medium bedded grey and buff weathering silty limestone with massive white limestone and well bedded tan grey limestone in the upper part of the unit.
 - SDs Silurian and Devonian: thick bedded to massive light grey dolostone and limestone.
- Cambrian to Silurian**
- CSM Marmot Formation: dark green to brown mafic, vesicular and amygdaloidal volcanic flows.
- Lower and Middle Cambrian**
- InCs Slat Creek Formation: rusty brown turbidic quartz sandstone, minor shale and siltstone.
 - ICI Iltyd Formation: light grey, medium bedded dolostone and limestone.
- Upper Proterozoic to Lower Cambrian**
- PCH Hyland Group: brown quartz-mica schist with rare limestone.

- Middle Proterozoic**
- mPPF Fifteen Mile Group: red, green and grey shale to silty dolomite.
 - mPH Hart River Formation: dark weathering mafic volcanic flows.
- Lower Proterozoic**
- IPG Gillespie Lake Group: orange-brown dolostone and sandstone.
 - IPO Quartet Group: black shale and siltstone.
- Structural Symbols**
- ↕ High angle fault
 - ▶ Thrust fault
 - Defined contact
 - Inferred contact
 - ★ Showing

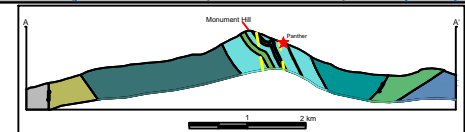

ATAC RESOURCES LTD.
 ARCHER, CATHRO & ASSOCIATES (1981) LIMITED
FIGURE 7-3
PROPERTY GEOLOGY
RAU PROPERTY

0 1 3 10 km

FILE: F_7.3.dwg DATE: JUNE 2014

The Bouvette Formation is the most abundant inferred rock type shown on government based maps and is the principal focus of ATAC Resources Ltd. exploration. It can be divided into three main units that young to the northeast. In order from oldest to youngest:

- 1) Cambrian and Ordovician – massive pale grey dolostone, oncolitic dolostone, minor quartzite and sandy dolostone.*
- 2) Ordovician and/or Silurian – thin to medium bedded grey and buff weathering silty limestone; massive white limestone, well bedded tan and grey limestone in the upper part of the unit.*
- 3) Silurian and Devonian – thick bedded to massive light grey dolostone and limestone. Dark grey, fetid limestone that contains “two-hole” and “star” crinoids occurs at the top of the unit.*

The thickness of the Bouvette Formation on the Property is estimated to be at least 1,400 meters. The primary focus of mapping has been largely limited to the area around Monument Hill and the Tiger Deposit within the Ordovician-Silurian strata hosting carbonate gold replacement mineralization. Elsewhere the Bouvette Formation has not been mapped in detail and remains undifferentiated.

A narrow sliver of Middle Proterozoic Fifteen Mile Group dolostone lies beneath the Bouvette Formation, to the southwest. This unit is composed of chocolate to orange brown weathering, cryptalgal laminated, medium to thick bedded dolostone, overlain by rusty brown weathering, olive green siltstone and shale with lesser maroon black and buff shale.

The Marmot Formation consists of thin volcanic horizons that are inter-bedded with the Ordovician and/or Silurian Bouvette Formation. The horizons range from a few meters to about 20 meters thick and comprise dark green to brown weathering mafic, vesicular volcanic flows, carbonate-cemented hyaloclastic breccias and volcanic-derived sandstone, grit and pebble and cobble conglomerate. Locally these horizons are magnetic. Although the Marmot Formation is volumetrically insignificant, it appears to have played an important role in localizing mineralization in the underlying carbonate by acting as an impermeable cap.

Devonian and Mississippian Earn Group rocks are located in the southern half of the Property and bounds the Bouvette Formation to the south, east and north. This unit is

generally recessive weathering and is mostly composed of black shale and chert. To the south a high angle normal fault places Earn Group against Bouvette Formation, while a thrust fault marks the southeastern contact. To the north, the Earn Group conformably lies above Cambrian to Devonian shale and limestone, which has been placed against the Bouvette Formation by another high angle fault.

The central part of the Property hosts numerous dykes and sills believed to represent a roughly 1000 m diameter granitic plug referred to as the "Rackla Pluton". The plug is mostly composed of coarse grained, equigranular, biotite-and muscovite-bearing granite that locally is miarolitic (Panton, 2008). The dykes and sills typically range between 30 centimeters and seven meters in thickness. They are often more fractionated than the plug and include garnet bearing aplite and coarse pegmatite that locally features beryl, amazonite (a green variety of feldspar) and one or more tourmaline minerals (rubellite, indigolite and schorl). The pegmatite bodies comprise mainly orthoclase and quartz but often exhibit abundant lithium-and vanadium-rich micas on their margins.

On surface, the Rackla Pluton is mostly covered by glacial till and only aplite and pegmatite sills and dykes are visible. The pluton is best delineated by its airborne magnetic signature. At the property scale the pluton is represented by a strong magnetic high. When the data is collapsed to the area immediately surrounding the pluton and a high-pass filter is applied, the signature shows a core magnetic low with a fringing magnetic high.

Analysis of several small bodies of granitic aplite and pegmatite have yielded $^{40}\text{Ar}/^{39}\text{Ar}$ muscovite ages of 62.3 ± 0.7 Ma, 62.4 ± 1.8 Ma and 59.1 ± 2.0 Ma (Kingston, 2009 and Kingston et al., 2010). Based on this data and the composition of the intrusion, Kingston concludes that the Rackla Pluton is younger than the McQuesten Suite (65.2 ± 2.0 Ma) intrusive bodies.

Skarn and minor hornfels are developed locally within the Bouvette Formation proximal to the intrusions. Skarn grades from distal tremolite-rich (iron-deficient) facies, which are most abundant near the Flat Top Showing (about 1 000 meters northwest of the pluton), to proximal actinolite-diopside \pm garnet \pm pyrrhotite (iron-rich) facies, which are found closer to the pluton and on the margins of some dykes and sills. Massive skarns are mostly developed at contacts between limestone and volcanoclastic horizons. Hornfels is restricted to thin volcanoclastic layers within the Marmot Formation. It is normally rusty weathering and often contains disseminated to semi-massive pyrrhotite. Limestone and dolomite are locally altered to marble and often contain disseminated,

light grey scapolite crystals. The scapolite is difficult to recognize on freshly broken surfaces but stands out on weathered surfaces as prismatic randomly orientated crystals.

7.3 Deposit Scale Lithology

During 2010 detail deposit scale mapping was conducted within the Bouvette Formation carbonate sequence in the vicinity of the Tiger Deposit mineralization. This work was conducted at different periods during the field season by Dr. Elizabeth Turner (Laurentian University), Dr. Harry E. Cook (Nevada consultant and formerly with the USGS) and Archer Cathro personnel. The following descriptions are largely based upon the observations made by Drs. Turner and Cook.

The stratigraphy of the carbonate sequence at the Tiger Deposit was established using rock texture, fossil composition and relationships with the inter-layered non-carbonate material. Most carbonate, volcanic flow and volcanoclastic lithostratigraphic units exposed at surface are relatively laterally continuous but differences in structural thinning of individual units are evidenced.

The stratigraphic succession exposed at surface above the Tiger Deposit mineralization consists of ten carbonate units (0-10) and seven intercalated non-carbonate units (A-G). Carbonate units 1 through 10 are identified based largely on their fossil composition, textures and relationships with associated volcanic and volcanoclastic rocks. These carbonate units are grouped into four subtly distinct packages based on fossil content and rock texture. Non-carbonate units A through G consist of volcanic flows and associated reworked volcanic material.

The relationship of the map units and descriptions are illustrated in Figure 7-4.

ATAC RESOURCES LTD.

ARCHER, CATHRO & ASSOCIATES (1981) LIMITED
 FIGURE 7-4
 STRATIGRAPHIC SECTION - Tiger Zone
 RAU PROPERTY

FILE:2014RAU

DATE: JUNE 2014

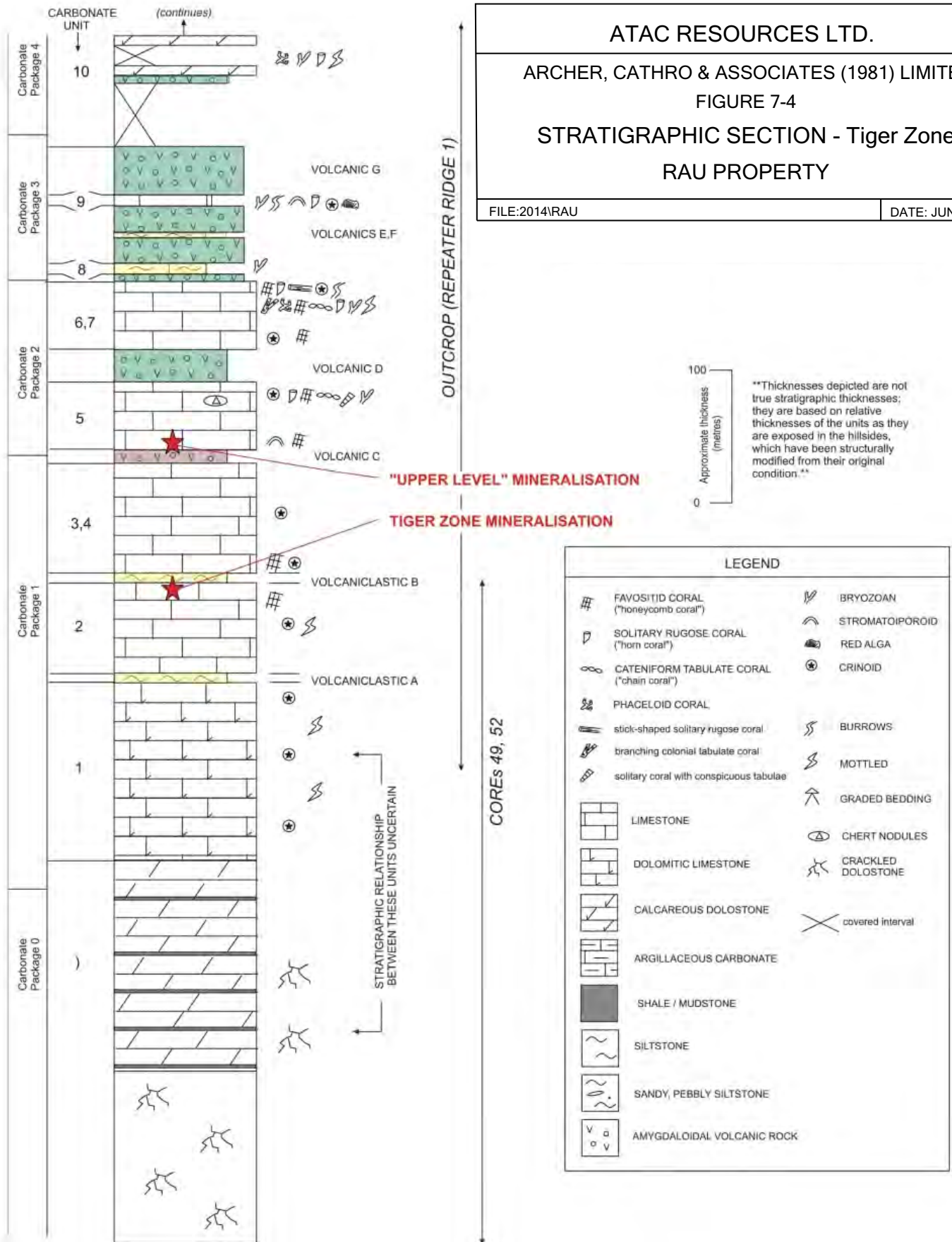

100
 Approximate thickness
 (metres)
 0

Thicknesses depicted are not true stratigraphic thicknesses; they are based on relative thicknesses of the units as they are exposed in the hillsides, which have been structurally modified from their original condition.

LEGEND

	FAVOSITID CORAL ("honeycomb coral")		BRYOZOAN
	SOLITARY RUGOSE CORAL ("horn coral")		STROMATOPOROID
	CATENIFORM TABULATE CORAL ("chain coral")		RED ALGA
	PHACELOID CORAL		CRINOID
	stick-shaped solitary rugose coral		BURROWS
	branching colonial tabulate coral		MOTTLED
	solitary coral with conspicuous tabulae		GRADED BEDDING
	LIMESTONE		CHERT NODULES
	DOLOMITIC LIMESTONE		CRACKLED DOLOSTONE
	CALCAREOUS DOLOSTONE		covered interval
	ARGILLACEOUS CARBONATE		
	SHALE / MUDSTONE		
	SILTSTONE		
	SANDY, PEBBLY SILTSTONE		
	AMYGDALOIDAL VOLCANIC ROCK		

STRATIGRAPHIC RELATIONSHIP BETWEEN THESE UNITS UNCERTAIN

Mineralization at the Tiger Deposit is hosted by carbonates in the middle of the succession near the contact of Carbonate Unit 2 and Volcaniclastic Unit B. Additional mineralization in an upper horizon occurs within carbonates of the lower Carbonate Unit 5 immediately above the lowest amygdaloidal volcanic unit. A brief description of all pertinent stratigraphy comprising the stratigraphic column is contained below.

Carbonate Unit 0 consists of graded beds of dark grey to black, variably calcareous mudstone or argillaceous carbonate mudstone, interlayered with paler layers of coarser particles. Original layering is generally obliterated by collapse brecciation, such that dark and light breccia clasts are intermingled. The original layering, where preserved, represents turbidites. This lithofacies passes downward into crystalline dolostone with no hint of original rock texture. The exact relationship with overlying units 1-10 is uncertain because the core crosses a presumed fault zone.

Carbonate Unit 1 is dominated by crinoid wackestone and lime mudstone, with rare favositid and halysitid coral fragments and solitary rugose corals. Yellow dolomitic mottles are locally conspicuous.

Volcaniclastic Unit A consists of sericitized silt- to mud-grade clastic material presumed to be of volcanic origin. It may be laterally equivalent to a thin pyroclastic flow exposed on the knoll of the Puma showing.

Carbonate Unit 2 is dominated by lime mudstone with rare crinoid fragments. Layering and sedimentary structures are generally absent.

Volcaniclastic Unit B consists of sericitized silt- to mud-grade clastic material and local granule-grade particles, and is presumed to be of volcanic origin. It may be laterally equivalent to a thick pyroclastic flow exposed on the knoll of the Puma showing.

Carbonate Units 3 and 4 are dominated by crinoid wackestone and lime mudstone, with no layering or sedimentary structures.

Volcanic Unit C consists of brownish-green-weathering variably amygdaloidal volcanic flows and associated volcaniclastic material.

Carbonate Units 5 to 7 consist of lime mudstone to crinoid wackestone with rare large fossils that are dominated by a range of tabulate and rugose corals and distributed both as isolated specimens and in conspicuous fossil-rich rudstone to floatstone layers.

Carbonates 5 and 6 are separated by a green-weathering volcanic flow unit (Volcanic D). Carbonate 7 is overlain by volcanic flow unit E.

Volcanic Unit D is a conspicuously green-weathering volcanic flow unit that generally lacks vesicular textures. It lies between carbonate units 5 and 6.

Volcanic Unit E is a very thin (several m), green-weathering amygdaloidal flow unit

Carbonate Unit 8 is very thin and lies between volcanic flow units E and F. It consists of bryozoan floatstone in a matrix of mixed carbonate mudstone and volcanoclastic fines.

Carbonate Unit 9 thinly separates volcanic flow units F and G, and consists of lime mudstone and skeletal wackestone with a characteristic fauna of bryozoans, rugose corals and crinoid fragments.

Volcanic Unit F is a green-grey-weathering amygdaloidal flow unit.

Carbonate Unit 10 is a group of different rock types, including distinctly mottled carbonates, lenses of amygdaloidal volcanic rock and bright orange marker dolostone layers. The biota is dominated by large phaceloid tabulate corals, bryozoans, and rugose corals concentrated in certain beds only. This part of the succession was not examined in detail. Its contact with the underlying volcanic succession (volcanics E-G) may be structurally modified.

7.4 Mineralization

Several types of mineralization are known to occur on the Rau Property including: 1) sediment-hosted replacement-style gold; 2) zinc±silver±lead±gold±bismuth in limonite-rich veins and replacement bodies; 3) scheelite in tremolite skarns; 4) pyrrhotite±scheelite±chalcopyrite in actinolite-diopside±garnet skarns; 5) wolframite±tantallite in granite; 6) gold bearing quartz-boulangerite veins; and 7) pyrite-sphalerite-galena in carbonate replacement deposits. The sediment-hosted replacement style gold mineralization is the most significant economic mineralization explored on the Property to date and includes the Tiger Deposit.

Replacement Style Gold Mineralization – Tiger Deposit

Replacement style gold mineralization has been the primary focus of exploration on the Rau Property. The Tiger Deposit is the best understood and most aggressively explored occurrence of that type identified to date and is the focus of this technical report.

Tiger Deposit

The Tiger Deposit is located 3 km west-northwest of the Rackla Pluton in a moderate to steep walled valley. It consists of a thick northwesterly trending body of carbonate replacement style gold mineralization hosted by a moderately northeast dipping horizon. It is currently 700 meters long, 100 to 200 meters wide and up to 96 meters thick. Mineralization is developed within and adjacent to a regionally extensive corridor of highly strained rocks that are manifested as a 40 to 150 meter wide zone of small scale folding and shearing. The geometry of the mineralized system is defined by a series of stacked and folded carbonate horizons intercalated with locally extensive mafic flows and volcanoclastic units.

Most of the exploration at the Tiger Deposit has been directed toward the Discovery Horizon, although there is evidence of at least one additional stratabound interval of gold mineralization above the Discovery Horizon.

Due to a combination of topography, overburden and stratigraphic orientation, the Discovery Horizon is the only mineralized horizon observed at surface. It is exposed over a 75 meter long by 10 meter wide area on the east side of Tiger Creek. At the northeast end of this exposure, a hand trench dug in 2009 uncovered moderately oxidized limonite boxwork with remnant sulfide mineralization, capped by highly sericite altered volcanoclastic unit. Two samples of sub crop collected in 2008 from the area near this trench returned 22.5 g/t gold, greater than 1% arsenic, 415 ppm bismuth and 116 ppm tungsten; and 13.6 g/t gold, greater than 1% arsenic, 410 ppm bismuth and 51.9 ppm tungsten.

Gold occurs in both sulfide and oxide facies mineralization at the Tiger Deposit. Sulfide mineralization is accompanied by, and developed within, limestone that is replaced by ferruginous dolomite and iron carbonate minerals. Sulfide species consist of disseminated to banded pyrite, with subordinate arsenopyrite and pyrrhotite and minor bismuthinite and sphalerite. Small amounts of disseminated scheelite are also present. The main sulfide minerals exhibit at least three stages of mineralization. The best

intersection from sulfide bearing mineralization averaged 4.04 g/t gold over 96.0 meters true width from hole Rau-09-66.

Oxide mineralization is completely devoid of sulfide minerals and ranges from very competent, weakly porous limonitic mud to rubbly porous limonitic grit. The oxide appears texturally amorphous within most intersections but occasionally exhibits residual color banding that may represent relict sulfide textures. Complete oxidation extends up to 150 meters from surface. The best oxide grades (e.g. hole Rau-09-19 assayed 24.07 g/t gold across 28.0 meters) and deepest oxidation occur where northerly trending extensional faults intersect the northwest trending regional shear structure. Detail observations predominantly collected from drill core on site are described below with respect to pre-mineralizing ground preparation and sulfide/oxide paragenesis. Much of this work is based on paragenetic studies conducted by Eric Theissen for his Master's thesis (Theissen, 2013).

Carbonate Ground Preparation

The favorable carbonate lithological horizons consist of carbonate units 2, 3, and 4. Carbonate unit 2 is expressed in drill core as mineralized and non-mineralized Tiger Deposit equivalent stratigraphy and carbonate units 3 and 4 occur stratigraphically above the Tiger Deposit mineralization.

Ground prepared units are characterized by grey fluid-assisted to solution collapse brecciated lime-mudstone to dolo-mudstone. Clasts average 3 to 10 centimeters and have sub-angular to sub-rounded to corrosive-irregular margins with many re-entrants due to dissolution and subsequent clast formation. These primary carbonate clasts average a homogenous to slightly mottled medium-grey colour. Mottling is due to bioturbation as well as irregular anastomosing stylo-mottling. Fossils and clastic textures are rare. Single-seamed serrated stylolites are common and may be as abundant as several hundred per meter in places. Polyphase carbonate and silicate fluid events establish what is observed today as classic karst dissolution and phreatic zone precipitation followed by subsequent open-space filling fluids.

The delicate and irregular margins of the carbonate clasts as well as the rarely preserved speleothems are the product of meteoric karsts that differ from the 'puzzle piece' angular fragments commonly produced from tectonic brecciation. The clasts and open space margins are lined by 'dog-tooth' calcite spar, white sub-centimeter size angular calcite crystals which are in turn often rimmed by a thin veneer of sub-mm size tabular pyrobitumen. The 'dog-tooth' calcite spar cement, which lines open spaces and clasts, is

a product of calcite crystallization in the phreatic zone of the meteoric realm, meaning that the open spaces were fully saturated with meteoric fluids allowing isopachous crystallization on all clast faces and open spaces. This calcite spar is also differentiated from marine cement since it exhibits a low-Mg calcite.

Regionally thrust and compressed basinal shales may be the source of pyrobitumen that channel through platform porosities. It is likely that petroleum residues once resided in the karst produced openings, later remobilized and are now lining the calcite spar. Open space filling is primarily composed of a clear anhedral pyrite-bearing quartz-calcite phase with other phases of grey coarse-grained calcite filling voids.

This carbonate unit is interpreted to have acted as a fluid pathway or ground preparation for the mineralization present today. The favorable mineralized horizon, Carbonate unit 2, bounded by two volcanic packages is exposed at surface.

Tiger Deposit sulfide paragenesis

The primary Tiger Deposit mineralization occurred in at least three distinct events with potentially more cryptic events. The earliest recognizable event in the Tiger Deposit, phase one, is a pervasive, fabric destructive, re-crystallized hydrothermal ankerite phase associated with arsenopyrite. The ankerite occurs as medium to coarse-grained euhedral to anhedral angular crystals that have no distinct sign of strain. Some mineralized open spaces, postulated to be equivalent to the karstification vugs in non-mineralized units, display hydrothermal saddle ankerite with curvilinear crystal faces. The ankerite varies in colour from a deep peach-salmon colour to a white-buff colour.

Ankerite in the Tiger Deposit occurs in these two seemingly distinct forms, the white version is dolomite as confirmed using the carbonate staining technique 'Alizarin Red and Potassium Ferricyanide'. The arsenopyrite occurs commonly as disseminations to weakly bedding/cleavage plane parallel and crystals are medium to coarse-grained and commonly euhedral. Arsenopyrite crystals appear to be in equilibrium with the initial carbonate phases as well as being unstrained. The arsenopyrite and ankerite are thought to have been precipitated by a common arsenian and iron rich hydrothermal fluid.

Phase two of the sulfide mineralization is characterized by pyrite precipitated in a strained environment to produce parallel bands (stripes) that give rise to the "Tiger" stripe nature of sulfide mineralization.

This pyrite is referred to as pyrite-1 and occurs as medium to fine-grained commonly cubic euhedral grains that cut between ankerite grain boundaries and across arsenopyrite in a non-destructive manner. Moreover, pyrite 1 overprints the ankerite and arsenopyrite yet appears in equilibrium with these phases as they remain euhedral and in their primary form. The pyrite-1 banding is parallel to the banding developed within the volcanic packages bounding the Tiger Deposit stratigraphy, and thus thought to be coeval. Although no obvious ductile structures occur within the Tiger Deposit sulfide mineralization, sigmoidal shear bands amongst other shear sense indicators occur in the foliation parallel fabric of the bounding volcanic units (personal communication, John Fedorowich, 2010). These observations as well as the lack of brittle features within the Tiger Deposit sulfide mineralization indicate that pyrite-1 was likely precipitated during a ductile stress regime. This shearing is also likely responsible for the alignment of the micaceous cleavage in the bounding volcanic packages and has aided in the broken nature of those units along their sericitized micaceous foliations.

A grey coarse-grained euhedral and often zoned ferro-dolomite occurs as a late stage mineral phase within phase two that hosts pyrite-1 mineralization. This ferro-dolomite occurs in bands parallel to pyrite-1, and may exist as thin millimeter-scale or thick centimeter-scale units. The ferro-dolomite often occurs along the same foliation plane as pyrite-1, surrounding the sulfide and giving the appearance of coeval precipitation. This ferro-dolomite is suggested to be a late stage mineral in the same phase because it also intrudes parallel and between pyrite-1 bands plastically deforming the once planar pyrite-1 fabric.

The next stage in mineralization, phase three, consists of an intruding fluid phase of quartz-ferro-calcite-talc +/- pyrite-pyrrhotite-bismuthinite-sphalerite and is potentially associated with secondary magnetite and biotite. This fluid phase is destructive and overprints all minerals in phases one and two. A second pyrite (pyrite-2) occurs and overprints all mineral phases in phase one and two, but is overprinted or destroyed by the intruding fluids of phase three.

Pyrite-2 occurs as fine to very-fine anhedral grains commonly with a dull green hue and pervasively overprints all previous phases.

Its most common occurrence is as anhedral diffuse masses but also occurs parallel to pyrite-1 bands and cuts obliquely across foliation to pyrite-1. Rather than placing pyrite-2 into its own class or fluid phase, it is suggested that pyrite-2 is a product of pyrite-1 from phase two interacting with the fluids and stress regime of phase three. Because pyrite-2 is cut by the mineral phases in phase three, phase three is by inference a later

phase. Pyrite-2 often forms parallel to pyrite-1 bands, and is commonly rimmed on its margins by a medium to fine-grained pyrite diagnostic of pyrite-1. This infers that pyrite-2 is not necessarily a newly precipitated mineral but that it could be the product of re-crystallization of pyrite-1 in a slightly different stress regime. The fine-grained dull nature of pyrite-2 thus may be characteristic of sub-grain formation via dynamic recovery mechanisms or thermally induced grain boundary migration.

The notion of phase three occurring in a different stress regime is due to oblique overprinting of pyrite-2 over pyrite-1, as well as phase three fluids that commonly crosscut earlier phases oblique to the pyrite-1 bands.

Phase three minerals consist of quartz-ferro-calcite-talc \pm pyrite-pyrrhotite-bismuthinite.

This mineral phase is not always observed together but when they do they exhibit a distinct relationship. Rimming phase three is a grey to white coloured fibrous ferro-calcite, the fibrous nature is accompanied by talc crystals and occur perpendicular to the phases contacts. Quartz commonly is central in the intruding phase as coarse-grained subangular grains. Pyrite-3 occurs as medium to coarse-grained angular to euhedral grains disseminated within the fluid phase as well as disseminated overprinting phase one and two minerals in close proximity to phase three.

The pyrrhotite occurs mostly as fine-grained anhedral masses within the ferro-calcite or interstitial to the quartz, and more rarely interstitial to the quartz and more rarely interstitial to the phase one and two minerals. Pyrrhotite rarely occurs as 1-2 meter intervals of massive sulfide where phase three fluids have had profound influence. Red sphalerite occurs in very small amounts as anhedral fine- to medium- sized grains within late calcite veins that cut all phases. Phase three is associated with the destruction of previous mineralization phases including arsenopyrite.

Tiger Deposit Oxide Mineralization

The overall character of the oxide zone is partial to complete destruction of primary features and rarely preserved secondary features. The oxide is a combination of siderite, goethite and limonite (potentially more phases) that vary from moderately hard competent sections to gritty-clay to silt rich rubble. Oxide colour varies from deep red to bright orange-rust to dark brown in color.

Transition zones of oxide to sulfide where the rock has not undergone complete destruction, support first order observations that can be made on general paragenesis.

Non-oxidized rock is often equivalent to Tiger Deposit sulfide mineralization with minor but important differences. Typically the ankerite and phase three minerals are present; however there is usually a depletion of arsenopyrite accompanied by strong iron staining throughout. Strongly oxidized portions may show a fine-grained diffuse pyrite (pyrite-2?) that is resistant to the oxidation. Brittle core axis parallel fractures occur more frequently in these sulfide-oxide transition zones and are thought to be attributed to a higher fracture density proximal to the late north trending structures.

Alteration phases

Sericite alteration is light brown to pale yellow and often occurs within the volcanic horizons proximal to the Tiger Deposit. The sericite is best developed at the upper and lower contacts of the volcanic packages bounding the Tiger Deposit sulfide mineralization. The sericitized volcanics have a preferred banding/cleavage developed parallel to pyrite-1 and is thought to be coeval with pyrite-1. Pyrite-2 is observed to overprint sericitized volcanic units thus sericitization occurred before pyrite-2 and phase three mineralization.

Talc forms white-to-grey fibrous-to-radiating crystals associated with the ferro-calcite minerals of phase three. The talc is most often rimming a phase three fluid intrusion with ferro-calcite surrounding a central quartz phase.

Potassic alteration occurs as an overprinting biotite-magnetite-calcite phase mostly within the volcanic packages, and more specifically within the sericitized units. This phase commonly intrudes and occurs as bleb-like clear calcite masses with rounded boundaries connected to one another by an irregular stockwork pattern.

These intrusions bend and warp the cleaved and wispy sericitized ash within the volcanics. Rimming the calcite phase is a fine-grained biotite that lines the calcite contacts by a thin brown demarcation. Magnetite often occurs as fine-grained euhedral disseminations throughout the volcanic units and may occur in more concentrated masses. This late phase fluid also precipitates an anhedral fine-grained pyrite and pyrrhotite usually within the calcite phase. Relationships of this phase and phase three mineralization are unknown.

Lower Pyrite Zone

The Lower Massive Pyrite Zone is only observed in DDH Rau-08-18 and Rau-09-18. The host lithology is a heavily altered cryptic carbonate unit that occurs stratigraphically

beneath Tiger Deposit mineralization. Pyrite mineralization occurs in intervals tens of meters in length and is closely associated with quartz. The pyrite is coarse-grained, generally massive, angular to euhedral textured with variable amounts of clear to white anhedral quartz within interstices. Pyrite often exhibits a brittle fracturing habit of coarse-grain which are subsequently annealed around grain margins. These pyrite grain margins exhibit no fracturing and appear to be a recrystallization of the brittlely deformed pyrite. All primary textures of the limestone have been destroyed by the pervasive silicification.

This late quartz-base metal mineralization is also observed as a late phase in the Tiger Deposit. Overall, this style of mineralization does not appear to be associated with the earlier gold mineralizing events.

East Zone Mineralization

The East Zone occurs in a litho-stratigraphical unit equivalent to the Tiger Deposit mineralization down dip to the southeast and structurally down dropped. Key distinctions that differ from the East Zone from the Tiger Deposit are a decrease in hydrothermal ankerite and arsenopyrite and an increase in phase three mineralization, in particular pyrite-3 accompanied by pyrrhotite and talc.

The East Zone horizon, where unaltered, displays karst solution brecciation and subsequent dogtooth spar, bitumen, and quartz infilling. This carbonate package is bound by traceable volcanic units that correlate to the equivalent litho-stratigraphy as the Tiger Deposit horizon. Typical Tiger Deposit mineralization, ankeritization and foliated pyrite (phase 1 and phase 2), occur replacing carbonate textures in only a few of the East Zone intersections. Tiger Deposit equivalent style mineralization within the East Zone occurs in small discrete intervals, has low amounts of arsenopyrite, and becomes non-existent down dip to the southeast. Massive pyrite and quartz occur in discrete intervals separated by a light-grey 'bleached' silicified limestone.

Phase three mineralization (quartz-calcite-talc-pyrrhotite-pyrite-3-bismuthinite) occurs in much greater abundances in the East Zone overprinting mineralized units as well as overprinting unmineralized karsted limestone. Mineralization ranges from long intervals of coarse to fine-grained pyrite, to massive pyrrhotite and is commonly associated with extensive talc alteration. The pyrite occurs either as 'splashy' medium-grained disseminations, massive coarse-grains or massive fine-grains, and is often associated with quartz. All of these pyrite types overprint all previous phases including brecciated limestone and Tiger Deposit style mineralization.

Pyrrhotite-talc and lesser bismuthinite also occur in the East Zone in much higher proportions than in the Tiger Deposit and do not appear to be positively correlated to gold grade.

East Zone Alteration

Sericite: The volcanic packages bounding the East Zone are traceable and believed to be equivalent with the Tiger Deposit volcanic horizons. However, the volcanic horizons in the East Zone show a much stronger sericite alteration being very pale yellow and are often strongly cleaved. The sericite is mostly localized within what appears to be fine-grained volcanic ash and pumice fragments that occur as weak bands.

Potassic: The volcanic packages bounding the East Zone are also highly altered, in contrast to the moderately altered Tiger Deposit volcanics, by a calcite-biotite-pyrite-pyrrhotite-arsenopyrite phase. This alteration is much more pervasive and extensive compared to the Tiger Deposit 'potassic' alteration and in particular has much more biotite and pyrrhotite throughout. The calcite intrudes in rounded irregular masses connected by a stockwork calcite matrix. This phase bends and warps the sericitized ash fragments as it intrudes. The calcite is rimmed with fine-grained brown biotite crystals and has fine-grained anhedral pyrite and pyrrhotite within the phase. Arsenopyrite occurs as medium-grained euhedral crystals within this phase in the volcanic horizons above the East Zone.

Upper Tiger Zone

A mineralized zone was discovered by drilling above the East Zone mineralization in 2010 above the amygdaloidal Volcanic Unit C. The Upper Tiger Zone is between four and 11 meters thick and is almost identical to typical Tiger Deposit mineralization – on the west side of Tiger Creek. The ankerite in the Upper Tiger Zone is white and pyrite-1 is difficult to distinguish. The arsenopyrite is coarse-grained and very prevalent throughout the unit and appears to be in equilibrium with all other phases present. The upper and lower contacts of the Upper Tiger Zone are very sharp and consist of a white marble. Phase three mineralization is observed in small amounts in the Upper Tiger horizon.

Several other showings containing mineralization similar to that found at the Tiger Deposit have been identified on the Property. These include the Cub, Lion, Jaguar,

Panther, Cougar, Puma, Cheetah and Lynx Showings (Figure 4-3). All of the showings are occurrences of mineralized float found on grassy or talus covered slopes and ridges.

Replacement Style Gold Mineralization - Peripheral Occurrences

The Cub Showing occurs 575 meters to the east of the Tiger Deposit. Mineralized float was found in a 110 meter wide by 250 meter long area on a south facing talus covered slope. The showing coincides with a strong bismuth-in-soil anomaly (>200 ppm). Float samples typically yielded values of 200 ppm bismuth and include peak values of 1 645 ppm, 1,990 ppm and 6,160 ppm. Rock samples returned peak gold values of 1.08 g/t and 1.15 g/t. A float sample taken from the southeastern edge of the showing contained 18.15 g/t silver, 4,630 ppm lead and greater than 1% zinc. The sample that contained 1,990 ppm bismuth also produced the highest tungsten value (223 ppm).

The Lion Showing was discovered while surveying the Tiger Deposit drill access road. Here, strongly pitted orange-black limonite and orange-red limonitic siderite and dolomite cobbles were found 770 meters west of the Tiger Deposit. A sample of this material returned 0.17 g/t gold, greater than 1% arsenic, 2 000 ppm lead, 2,080 ppm tungsten and 1.36% zinc.

The Jaguar Showing is located on a grassy spur radiating outwards from the south side of Monument Hill. Thirteen samples were collected within a 400 meter by 300 meter area. Float samples generally consisted of dense, rusty purple, goethite-rich limonite with rare patches of quartz.

Two samples taken from this showing in 2009 returned 1.57 g/t and 2.81 g/t gold. Only cursory prospecting has been performed at this locale and the source of mineralization has yet to be identified.

The Panther Showing is situated along a ridge on the north side of Monument Hill. Limonite float was found within a north northeast trending recessive linear feature that marks the contact between limestone to the south and volcanoclastic to the north. A specimen returned 5.72 g/t gold, 5.01 g/t silver, 9,460 ppm arsenic, 61.7 ppm bismuth, 94.9 ppm lead and 1,070 ppm zinc. Limonitic float was also found downhill, to the north and yielded 0.06 g/t gold, 11.05 g/t silver, 6,200 ppm arsenic, 47.3 ppm bismuth, 2 100 ppm lead and 1.29% zinc. The source of mineralization has not yet been located.

The Cougar Showing is located in a north facing cirque, along the northwest slope of Monument Hill. Mineralized float is found in an avalanche chute which stretches

approximately 600 meters from the base of the hill to the ridge. This float train continues over the ridge and into the valley to the southeast. Cobbles of dense rusty limonite with rare blebby bismuthinite and galena in quartz occur in a talus field comprising mostly limestone with volcanoclastic material to the east and west. Mineralized float becomes more concentrated near the ridge, although no outcrop was located.

A number of samples collected from this float train produced elevated gold (1.57 g/t and 3.13 g/t) and silver values (483 g/t). Three samples taken near the ridge yielded greater than 1% bismuth; however, these samples were only slightly elevated for other elements. Arsenic values throughout the Cougar Showing were elevated and include peak values of 1.2% and 2.1%. Four samples yielded greater than 10% lead with a peak of 35.7%, while most samples contained below 5000 ppm lead. The sample yielding 1.57 g/t gold also contained 19.4% lead.

The Puma Showing is located on an east-facing slope approximately 750 meters northwest of the Cougar Showing. Oxidized cobbles were found scattered along a grassy hillside in a 250 meter by 450 meter area. Many of the samples collected from this showing are dense, rusty, dark purple siderite and goethite containing patches of box-work limonite. Other samples consisted of limonite or altered carbonate, with occasional narrow quartz veins containing bismuthinite and galena. Bismuthinite crystals, up to 3 centimeters long, were observed in one sample.

Six goethite or goethite rich limonite samples collected from the Puma Showing in 2009 returned gold values greater than 1.0 g/t including a peak value of 18.45 g/t gold. Silver ranged between 0.2 g/t and 68.8 g/t with four samples exceeding 100 g/t to a maximum of 241 g/t silver. Three samples collected from the Puma showing in 2013 assayed 9.62 g/t gold and 5.36 g/t silver, 8.92 g/t gold and 23 g/t silver, and 8.1 g/t gold and 8.7 g/t silver (R. Carne, pers. com., 2014)

The Cheetah Showing is located approximately 800 meters west northwest of the Puma Showing. A 500 meter long by 100 meter wide float train extends up a south facing slope to a ridge which is cut by a northeast trending linear. The linear was traced for approximately 30 meters to the northeast until becoming buried in limestone talus. A sample of a purple brown, goethite rich box-work limonite collected in 2009 returned an assay of 3.06 g/t gold.

Six diamond drill holes at the Cheetah Showing targeted a prominent linear feature corresponding to a 310 meter long string of anomalous soil samples. Drilling intersected dolomite and limestone cut by a steeply dipping oxidized zone. The most significant

intersection came from CH-10-04 and graded 1.29 g/t gold over 16.9 meters core length. The true width cannot be determined until the orientation of the mineralization has been established.

The Lynx Showing is located 2.3 km west of Monument Hill and consists of isolated limonite float within a limestone talus field. This showing is located on the opposite side of the valley as the Cheetah Showing. A sample collected at the Lynx returned 0.24 g/t gold, 7,290 ppm arsenic, 789 ppm lead and 5,970 ppm zinc. A similar sample, collected 700 meters to the east, yielded 1.45 g/t gold.

Scheelite Tremolite-Actinolite Skarns

Four known tungsten skarn showings occur on the Rau Property (Figure 4-3). Three of these are located less than 1.5 km from the Rackla Pluton, while the fourth is located 4.8 km to the north. They are a combination of scheelite-tremolite and actinolite skarns containing varying concentrations of pyrite, pyrrhotite and rare chalcopyrite. These showings have associated moderate to strong tungsten, gold and copper soil geochemical anomalies (Dumala, 2009).

The Hogs Back Showing is located 800 meters southwest of the pluton. This showing is exposed on the north and south side of a northwest trending gully. It was first identified in 2006 and followed up in 2007. The showing consists of three actinolite skarn layers occurring conformably within a portion of the Bouvette limestone sequence. Mineralization comprises finely disseminated to patchy pyrrhotite, pyrite and lesser chalcopyrite. Marble in the enclosing limestone is variable but extends up to 5 meters in areas. The skarn layers have been traced to the northwest for over 750 meters and vary in thickness from 0.3 meters to 6 meters, averaging 0.8 meters. The thickest and best mineralized exposure occurs at the southeast edge of a crosscutting drainage before disappearing to the southeast beneath cover. In general the exposed skarn horizons appear too thin to the northwest.

The two thickest packages of mineralization appear proximal to a pair of southwest striking, quartz muscovite pegmatite dykes. The northwesterly dyke is one meter wide and exposed along strike for only two m, while the dyke to the southwest is three meters wide and exposed for ten meters. No direct contact was observed between the dykes and the skarns.

Select rock samples collected from this showing in 2006 and 2007 yielded peak values of 4010 ppm tungsten and 1.24 g/t gold from the north side of the showing (Dumala, 2008),

while chip samples collected in 2009 from the south side returned gold values less than 0.05 g/t, and a peak tungsten result of 3,110 ppm. A one meter chip sample of sugary weathered limestone containing fine grained pyrite that was taken between two skarn layers returned 0.45 g/t gold. A single diamond drill hole tested this showing in 2008; however, it was collared too far forward and did not intersect the skarn mineralization.

The Ridge Crest Showing, located on the southwest side of the Rackla Pluton, was discovered in 2009 while following up a gold-in-soil anomaly (990 ppb) within the 2007 sample grid. A 70 centimeter deep hand pit dug at this location revealed glacial till and grey limestone fragments. Two cobbles of rusty dark green pyroxene skarn and several oxidized skarn fragments were also extracted from this pit. Grab samples of the skarn yielded 0.02 g/t gold and 850 ppm tungsten. A dyke containing equigranular, coarse grained white to smoky quartz and minor muscovite with occasional patches of chlorite and trace fine grained sulfides occurs 15 meters to the west. A nearby float sample returned 1,060 ppm tungsten.

The Flat Top Showing occurs along a north trending ridge approximately 1.3 km northwest of the Rackla Pluton. It is localized along the contact between the Bouvette Formation and Earn Group strata. The showing is marked by approximately coincident, moderately to strongly anomalous gold, copper and tungsten soil geochemical values approximately 600 meters long and up to 300 meters wide. Scheelite in tremolite skarn was first found at this locale in 1979 by Prism. Prospecting in 2009 traced skarn mineralized float around the nose of the ridge for 400 meters.

Four types of skarn mineralization occur across a stratigraphic thickness of 40 meters. The first, found immediately above the contact, occurs as felted to radiating masses of acicular tremolite/actinolite or wollastonite/actinolite localized in a band that ranges from a few 10's of centimeters to a few meters thick. The second, found within unaltered carbonate rock, are masses of tremolite mixed with calcite found in 0.5 millimeter to 2 centimeter thick veinlets. Thirdly, an iron rich skarn consisting of coalescing aggregates of radiating acicular masses of tremolite/actinolite preferentially replaces the host carbonate. Rare interstitial green tourmaline or vesuvianite, calcite and quartz also occur with this skarn type. Finally extending upward from the contact is the most iron rich species. It contains felted masses of light green actinolite with local black tourmaline, biotite books, light grey to smoky quartz and patches of massive medium brown limonite.

Prism Resources reported rock samples assaying up to 8.38% WO_3 , although most samples collected from the area grade less than 0.04% WO_3 (Churchill, 1980). One

sample consisting of a quartz fragment surrounded by green actinolite with black tourmaline and traces of pyrrhotite returned 0.127 g/t gold. A single diamond drill hole tested the area in 2008 but it was collared too far downhill and only intersected shale belonging to the Earn Group.

The Blue Lite Showing, first discovered by the Prism Joint Venture in 1979, is a scheelite tremolite skarn located 4.8 km northeast of the Rackla Pluton. The skarn mineralization is well exposed on a cliffy outcrop on the north side of a prominent peak. Mineralization consists of scheelite as disseminations with massive pyrrhotite and minor chalcopyrite. The skarn horizon disappears under talus to the east and grass to the west. The Blue Lite Showing is located along a high angle normal fault that dips to the south. This fault marks the contact between Devonian-Mississippian clastics to the north and Devonian to Jurassic clastics to the south.

Samples collected by the Prism Joint Venture in 1979 from this showing returned between 0.02% and 4.3% WO_3 . A drill hole completed later that year yielded between 0.02% and 0.08% WO_3 in drill core across narrow widths. Three samples taken at the Blue Lite Showing in 2009 returned greater than 0.10% tungsten with a peak of 0.34%. Most of the other samples ranged from 200 to 950 ppm tungsten. Gold values were all below background, with a peak of 9 ppb. A sample collected by ATAC from the Blue Lite showing in 2013 returned 1.51 g/t gold (R. Carne, pers. com., 2014).

Gold-Bearing Quartz-Boulangerite Vein Style Mineralization

The Now Showing is situated within a pronounced northwest trending gully located approximately 8 km west of Monument Hill. Little outcrop is exposed here but abundant float occurs along more than 400 meters of the gully. Mineralization was first discovered in 1969 by Cominco Limited. Lead, zinc and copper anomalies were identified but no clear relationship between them was determined (Johnston and Richardson, 1969).

In the late 1970's the Prism Joint Venture conducted soil sampling, mapping, trenching and diamond drilling. Results of this soil sampling included values ranging from background to 7.4 g/t silver, 2.51 % lead and 790 ppm zinc within extensive northwest trending anomalies. A rock sample collected from a hand dug pit graded 74 g/t silver, 2.15% lead and 790 ppm zinc (Montgomery and Dewonck, 1977). Two samples of quartz rubble containing boulangerite were retrieved from a partially completed trench. The trench failed to reach bedrock due to permafrost but the grab samples returned 38.06 g/t gold, 343.55 g/t silver, 47.2% lead and 0.01% zinc and 39.43 g/t gold, 581.49 g/t silver, 23.26% lead and 0.06% zinc.

The most encouraging drill results obtained by the Prism Joint Venture were from two holes that tested beneath this trench. The first of these holes intersected boulangerite and sphalerite in a narrow quartz vein. A narrow interval yielded 1.51 g/t gold, 54.5 g/t silver, 2.74% lead and 5.26% zinc over 0.5 meters. The second hole, drilled at a steeper angle from the same pad, intersected the mineralized quartz vein that assayed 3.50 g/t gold, 60.3 g/t silver, 4.64% lead and 0.04% zinc over 1.1 meters. The true widths cannot be determined from the information in the report. The other four drill holes were either not sampled or contained no significant intersections.

In 1988, NDU Resources Ltd. collected rock samples in the areas identified by Cominco Limited and the Prism Joint Venture as being anomalous for zinc. Samples were collected from two blocky quartz veins, one with blebby galena and the other with jamesonite and boulangerite. The sample containing blebby galena graded greater than 1% lead while the sample containing jamesonite boulangerite contained greater than 1% lead and greater than 100 g/t silver (Cathro, 1989).

Prospecting by ATAC Resources Ltd. in 2009 revealed that these anomalies appears to follow the stratigraphy but are locally overprinted by one or more vein faults. The deep gully located near the Now Showing trends slightly oblique to bedding and corresponds to a main fault. Three of the six holes drilled by Prism are believed to have intersected this and are represented by gougy intervals surrounded by zones of intense veining. These intervals were not sampled.

Transported Gossans and Carbonate Replacement Lead-Zinc-Silver Mineralization

Two transported gossans occur on the Rau Property separated by approximately eighteen km. The Kathy Showing comprises a 40 meter wide by 30 meter long brick red gossanous ferricrete slab, located approximately 750 meters southeast of the Rackla Pluton. The gossan is situated downhill of a thrust fault that places Earn Group shale, to the south, over Bouvette Formation carbonates to the north. The interpretation is that the gossan is formed by fluids traveling along this thrust fault. Soil samples collected by the Prism Joint venture in 1978 returned silver values between 0.08 g/t and 25 g/t, lead values ranging from 32 to 90 ppm and zinc values ranging from 95 to 3,900 ppm. Results for other elements were not reported.

The Ocelot Showing (also referred to as EL) is located 11.5 km northwest of Monument Hill and was first identified by the Prism Joint Venture in 1978. The showing is marked by a 110 meter long by 25 meter wide gossan that formed by the precipitation of iron

oxides containing silver, lead and zinc from solutions traveling along a permeable horizon (Montgomery and Cavey, 1978). The gossan has a northwest orientation and parallels an adjacent topographic linear feature. The showing is most pronounced in a kill zone to the northwest that originates at a weakly flowing spring.

The gossan is predominately dolomite rubble cemented by iron oxides and is surrounded by buff to orange weathering dolomite and limestone. Soil samples collected by the Prism Joint Venture returned anomalous metal values that ranged up to peak values of 3.8 g/t silver, 800 ppm lead and 12.2% zinc.

Drilling near the Ocelot gossan in 2010, tested combined ground gravity and IP anomalies located uphill from the transported gossan. A total of 1,133.5 meters of drilling in five holes was completed at the Ocelot showing. The only significant mineralization intersected was in hole OC-10-01 that intersected 4.23 meters grading 552 g/t silver, 14.5% lead and 34.3% zinc from 49.12 meters to 53.35 meters. The true width of the interval cannot be determined as the orientation of the mineralization has not been determined.

In 2011, ATAC drilled 19 holes totaling 3,784.75 meters at the Ocelot gossan. This work intersected massive pyrite-sphalerite-galena mineralization in a 200 meter long, steeply dipping band in dolomite that was tested up to 250 meters from surface. True width ranges from 6 meters to 51 meters. The longest drill intersection assayed 8.18% zinc, 2.44% lead and 73.81 g/t silver over 63.44 m in hole OC-11-010. The richest drill intersection assayed 6.06% zinc, 8.69% lead and 188.01 g/t silver over 37.91 m in hole OC-11-011. This intersection included a galena-rich interval that assayed 20.44% lead, 9.50% zinc and 400.18 g/t silver (ATAC Resources Ltd., 2011).

8.0 DEPOSIT TYPES

The gold mineralization at the Tiger Deposit is sediment-hosted, carbonate replacement style gold mineralization. Carbonate replacement-type gold deposits are a class of gold deposits that span a broad classification from high temperature skarn/manto-type deposits through low temperature Carlin-type deposits. Although neither is completely unique to any locale, they do occur in great numbers in north-central Nevada and the total associated gold resource size there is considered world class. The Carlin-type deposits are characterized by concentrations of very finely disseminated gold in silty, carbonaceous, calcareous rock. The gold is present as micron-size to sub-micron-size disseminated grains, often internal to iron-sulfide minerals (arsenical pyrite is most common) or with carbonaceous material in the host rock. Free particulate gold, and particularly visible free gold, is not a common characteristic of these deposits thus significant placer alluvial concentrations of gold are not commonly produced when Carlin-type gold deposits are eroded.

Most of the Carlin-type deposits in Nevada have some general characteristics in common, although there is a wide spectrum of variants. Anomalous concentrations of arsenic, antimony, and mercury are typically associated with the gold mineralization; thallium, tungsten, and molybdenum may also be present in various amounts. Alteration of the gold-bearing host rocks of Carlin-type deposits is typically manifested by decalcification of the host, often with the addition of silica, addition of fine-grained disseminated sulfide minerals, remobilization and/or the addition of carbon to the rock, and late-stage barite and/or calcite veining. Small amounts of white clays (illite) can also be present. Decalcification of the host produces volume loss, with incipient collapse brecciation, which enhances the fluid channel ways of the mineralizing fluids. Due to the lack of free particulate gold, Carlin-type deposits generally do not have a coarse-gold assay problem common in many other types of gold deposits.

Deposit configurations and shapes are quite variable. Carlin-type deposits are typically somewhat stratiform, with mineralizing characteristics being best exhibited in specific stratigraphic units, although steeply dipping faults can host high-grade gold mineralization. Fault and solution breccias can also be primary hosts to mineralization.

The highest grade (5-15 g/t gold) gold skarn deposits are relatively reduced, are mined solely for their gold content, lack economic concentrations of other metals, and have a distinctive gold-bismuth-tellurium-arsenic geochemical association. Most high-grade gold skarns are associated with reduced ilmenite-bearing diorite-granodiorite plutons and

dike/sill complexes. They typically occur in clastic-rich protoliths rather than pure limestone and skarn alteration of dikes, sills, and volcanoclastic units is common. Reduced gold skarns are dominated by iron-rich pyroxene, but proximal zones can contain abundant intermediate grandite garnet. Other common minerals include K-feldspar, scapolite, vesuvianite, apatite, and amphibole. Distal/early zones contain biotite+K-feldspar hornfels that can extend for hundreds of meters beyond massive skarn. Due to the clastic-rich, carbonaceous nature of the sedimentary rocks in these deposits, most skarn is relatively fine-grained.

The mineralization identified at the Tiger Deposit shares characteristics of both Carlin-type gold systems and higher temperature intrusive related skarn systems, including:

- 1) Stratigraphic control on mineralization - mineralization is hosted primarily in dolomitized carbonate units;
- 2) Structural control on mineralization - mineralization occurs in karstic cavities, collapse breccias, anticlinal fold hinges and has undergone significant grade enhancement by late stage structural fluids;
- 3) Geochemical association - elevated arsenic, bismuth and tungsten accompany the gold mineralization, while silver and base-metal concentrations are generally low;
- 4) Alteration - mineralization is associated with initial dolomitization creating porosity and iron source for sulphidation, temperature gradients high enough to produce arsenopyrite and minor talc alteration.

Based on these observations associated with the Tiger Deposit mineralization, the most suitable classification is “sediment-hosted Nevada-type carbonate replacement style” gold mineralization.

Although the Author makes this comparison to the above-mentioned deposit type, the reader is cautioned that the Author cannot verify that these deposits are directly comparable with the mineralization at the Rau Property.

9.0 EXPLORATION

Exploration activities on the Rau Property prior to 2014 are referenced in this report as historical activities and are described in Section 6.0.

The diamond drilling programs, conducted between 2008 and 2010, that are the basis for the resource estimation reported herein, are discussed in Section 10.0.

9.1 Soil Sampling

Between 2007 and 2010 soil geochemical sampling was conducted within a 20 by 8 kilometer area of the Rau Ridge System defining the most favorable geological setting to host Tiger Deposit style mineralization (Figure 9-1). Soil geochemical data was collected by means of grid and contour sampling while drainage systems were evaluated by collecting stream sediment samples. At least 18,800 soil and stream sediment samples were collected along the favorable trend.

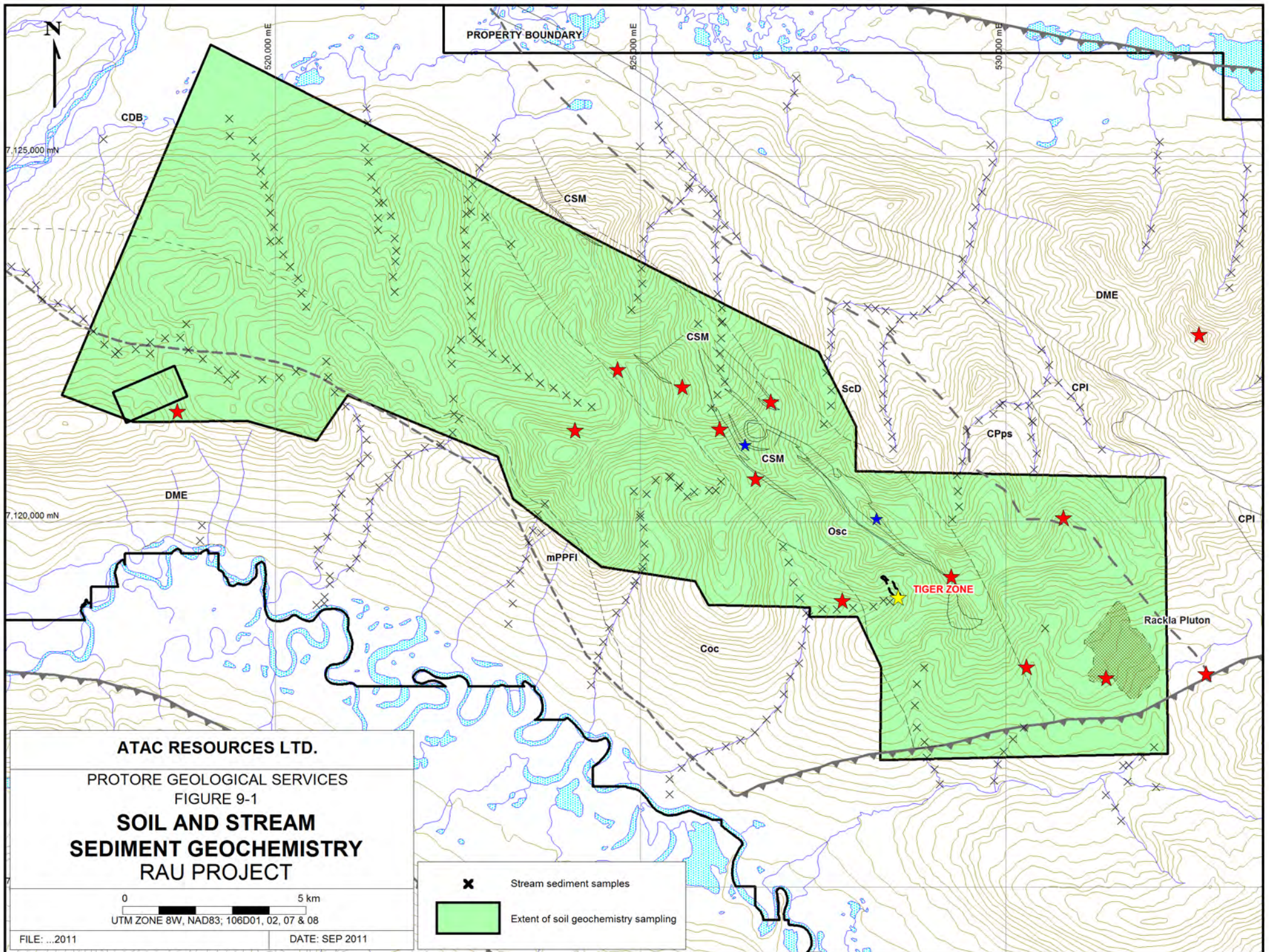

Grid samples were collected at 50 meter intervals along lines spaced 100 meters apart in most areas, while detailed 50 meter by 50 meter grids were established over the Now, Jaguar and Kathy Showings. The relative line positions were established using a handheld GPS, while sample spacing was maintained using compass and topofil chain. Sample sites are marked by wooden lath bearing aluminum tags inscribed with the corresponding sample number and the grid coordinates, where appropriate.

All soil samples were collected from holes that were dug with a mattock or hand auger to depths of 20 to 50 centimeters below surface. Soil was taken from the bottom of the holes and placed in pre-numbered Kraft paper bags. Above tree line, the samples consisted of poorly developed soils mixed with talus fines. At lower elevations, the sampled material mostly comprised residual soils mixed with glacially transported material.

Background and anomalous values for gold, arsenic and bismuth are summarized in Table 9-1. Background averages, weak, moderate, strong and very strong anomalous thresholds approximately correspond to the 50th, 90th, 98th, 99th and 99.9th percentiles.

Table 9-1
Geochemical Characteristics for Soil Samples, Rau Property

Level	Gold	Arsenic	Bismuth
Background	3	17	1
Weak	25	50	5
Moderate	50	100	10
Strong	100	200	25
Very Strong	200	500	50
Peak	11.65	10,005	1,300

(all values are ppm except gold which is ppb)

Integrated soil geochemical results for gold, arsenic and bismuth are illustrated on Figures 9-2 to 9-4 with the respective showings described in Section 6.0.

ATAC RESOURCES LTD.

PROTORE GEOLOGICAL SERVICES
FIGURE 9-2

GOLD SOIL AND STREAM SEDIMENT GEOCHEMISTRY RAU PROJECT

0 5 km
UTM ZONE 8W, NAD83; 106D01, 02, 07 & 08

FILE: ...2011

DATE: SEP 2011

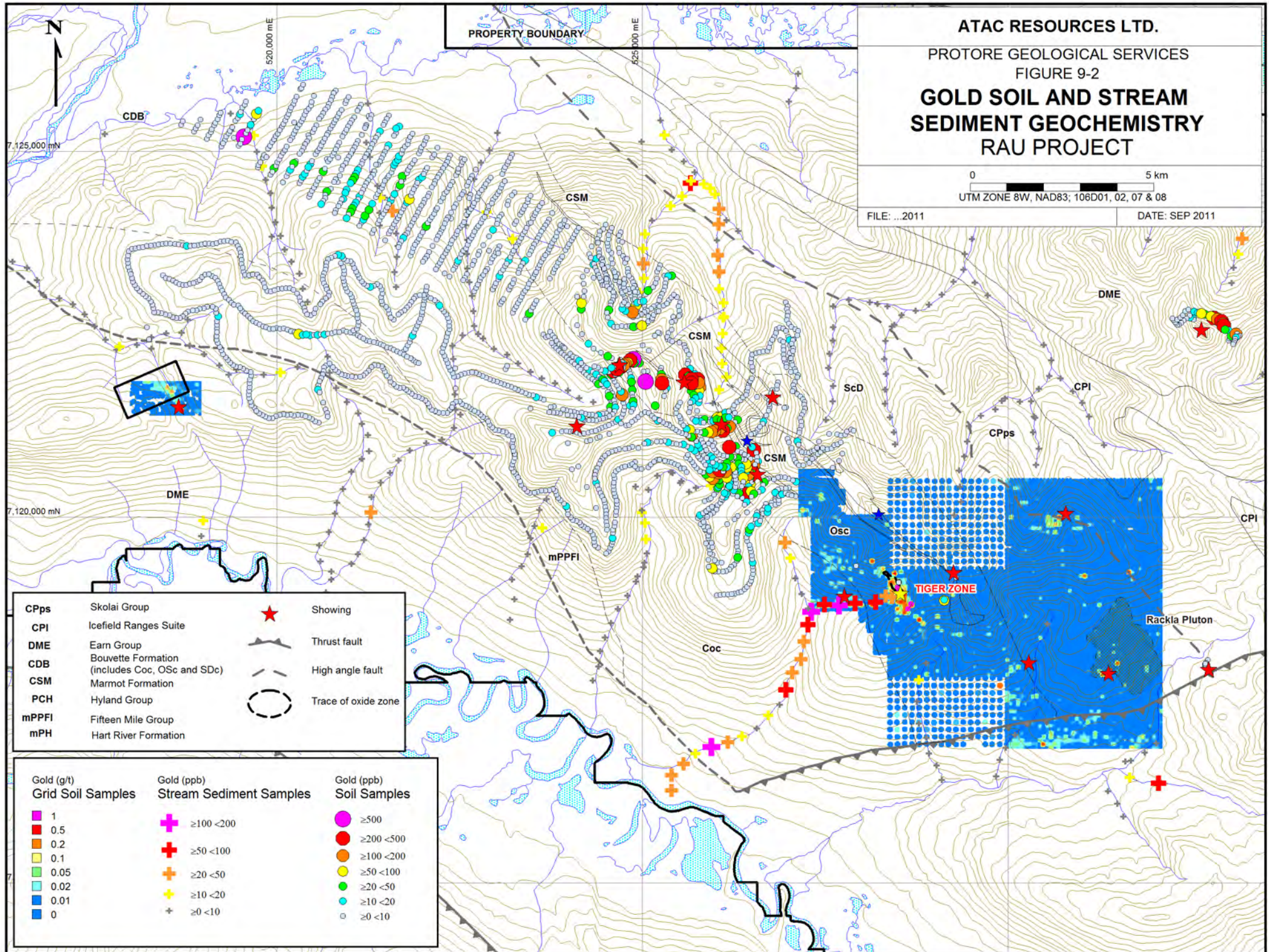

CPps	Skolai Group	★	Showing
CPI	Icefield Ranges Suite	▲	Thrust fault
DME	Earn Group	▬	High angle fault
CDB	Bouvette Formation (includes Coc, Osc and SDC)	○	Trace of oxide zone
CSM	Marmot Formation		
PCH	Hyland Group		
mPPFI	Fifteen Mile Group		
mPH	Hart River Formation		

Gold (g/t) Grid Soil Samples	Gold (ppb) Stream Sediment Samples	Gold (ppb) Soil Samples
■ 1	✦ ≥100 <200	● ≥500
■ 0.5	✦ ≥50 <100	● ≥200 <500
■ 0.2	✦ ≥20 <50	● ≥100 <200
■ 0.1	✦ ≥10 <20	● ≥50 <100
■ 0.05	✦ ≥10 <20	● ≥20 <50
■ 0.02	✦ ≥10 <20	● ≥10 <20
■ 0.01	✦ ≥10 <20	● ≥10 <20
■ 0	✦ ≥10 <20	○ ≥0 <10

ATAC RESOURCES LTD.

PROTORE GEOLOGICAL SERVICES
FIGURE 9-3

**ARSENIC SOIL AND STREAM
SEDIMENT GEOCHEMISTRY
RAU PROJECT**

0 5 km
UTM ZONE 8W, NAD83; 106D01, 02, 07 & 08

FILE: ...2011

DATE: SEP 2011

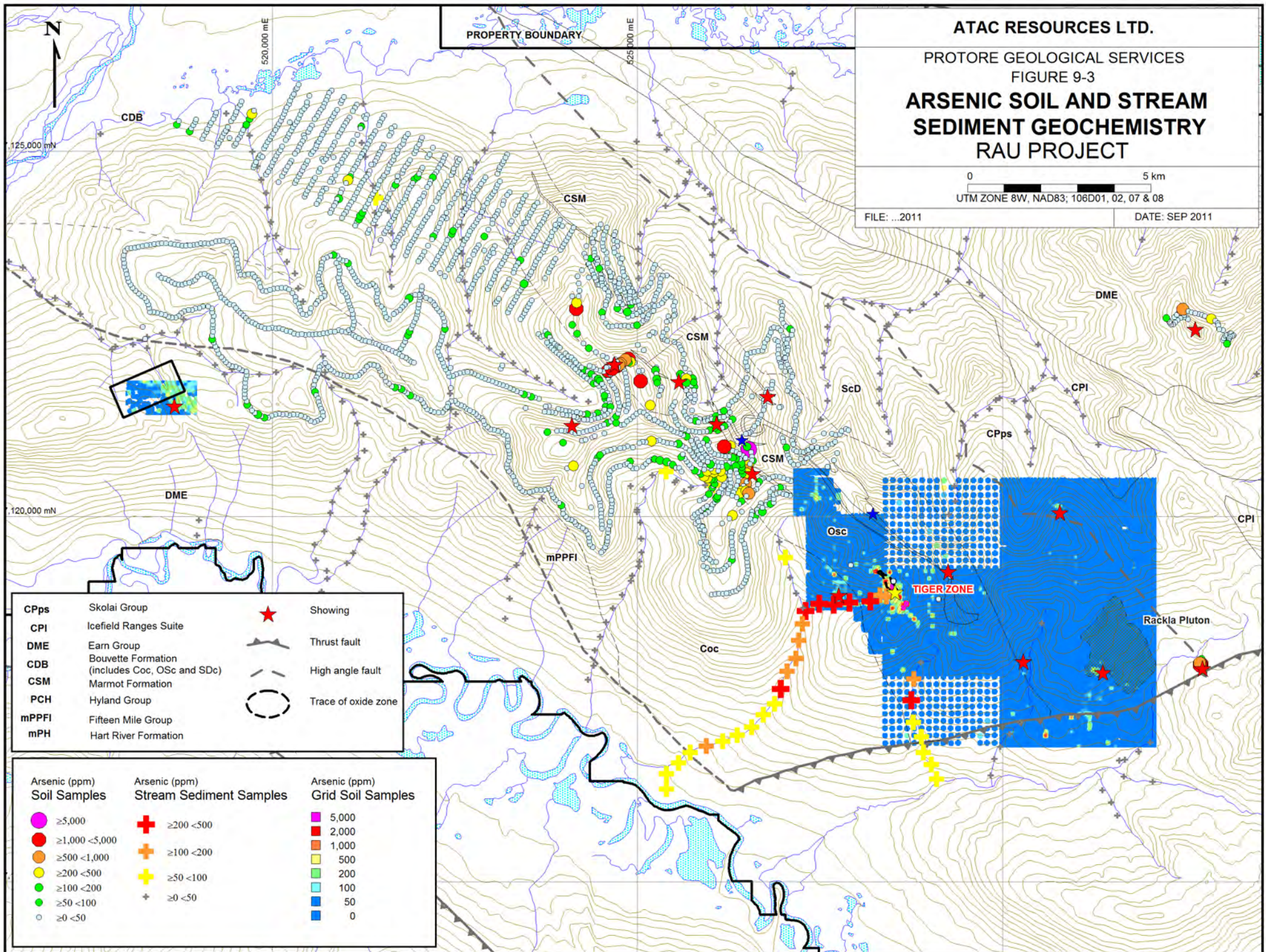

CPps	Skolai Group	★	Showing
CPI	Icefield Ranges Suite	—▲—	Thrust fault
DME	Earn Group	—▲—	Thrust fault
CDB	Bouvette Formation (includes Coc, OSc and SDC)	—▲—	High angle fault
CSM	Marmot Formation	—▲—	High angle fault
PCH	Hyland Group	○	Trace of oxide zone
mPPFI	Fifteen Mile Group	○	Trace of oxide zone
mPH	Hart River Formation	○	Trace of oxide zone

Arsenic (ppm) Soil Samples		Arsenic (ppm) Stream Sediment Samples		Arsenic (ppm) Grid Soil Samples	
●	≥5,000	+	≥200 <500	■	5,000
●	≥1,000 <5,000	+	≥100 <200	■	2,000
●	≥500 <1,000	+	≥50 <100	■	1,000
●	≥200 <500	+	≥50 <100	■	500
●	≥100 <200	+	≥50 <100	■	200
●	≥50 <100	+	≥50 <100	■	100
○	≥0 <50	+	≥0 <50	■	50
				■	0

ATAC RESOURCES LTD.

PROTORE GEOLOGICAL SERVICES
FIGURE 9-4

BISMUTH SOIL AND STREAM SEDIMENT GEOCHEMISTRY RAU PROJECT

0 5 km
UTM ZONE 8W, NAD83; 106D01, 02, 07 & 08

FILE: ...2011

DATE: SEP 2011

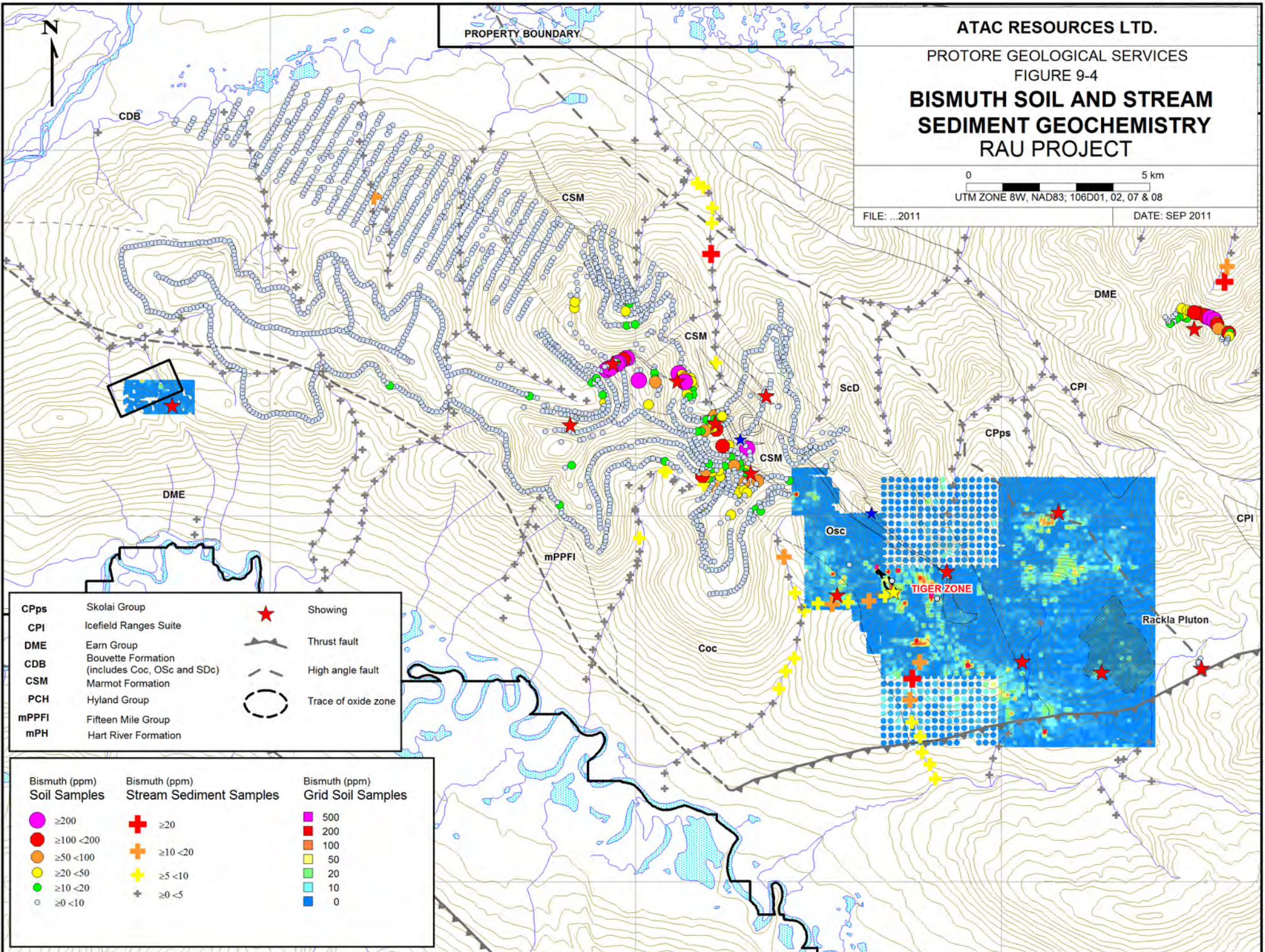

CPps	Skolai Group	★	Showing
CPI	Icefield Ranges Suite	▲	Thrust fault
DME	Earn Group	▬	High angle fault
CDB	Bouvette Formation (includes Coc, OSc and SDC)	○	Trace of oxide zone
CSM	Marmot Formation		
PCH	Hyland Group		
mPPFI	Fifteen Mile Group		
mPH	Hart River Formation		

Bismuth (ppm) Soil Samples	Bismuth (ppm) Stream Sediment Samples	Bismuth (ppm) Grid Soil Samples
● ≥200	★ ≥20	■ 500
● ≥100 <200	✚ ≥10 <20	■ 200
● ≥50 <100	✚ ≥5 <10	■ 100
● ≥20 <50	✚ ≥0 <5	■ 50
● ≥10 <20		■ 20
● ≥0 <10		■ 10
○ ≥0 <10		■ 0

9.2 Surface Rock Sampling

A total of 424 rock samples were collected from various targets along the Rau Ridge system between 2007 and 2010 (Figure 9-5). During 2007 only a limited amount of prospecting was conducted due to limited soil geochemical results available to follow up. The prospecting that was done was localized around the periphery of the Rackla Pluton in close proximity to the surrounding carbonates focusing on proximal tungsten-gold skarn potential. Forty-four grab samples were collected and submitted for 34 element Induced Coupled Plasma (ICP) analyses in addition to gold by fire assay and tungsten by x-ray fluorescence procedures. Samples of mineralized actinolite-diopside skarn generally returned low values but some material returned up to 3.23% WO₃ and one sample yielded a gold value of 1.24 g/t (Eaton and Panton, 2008).

ATAC RESOURCES LTD.

PROTORE GEOLOGICAL SERVICES

FIGURE 9-5

ROCK SAMPLE LOCATION

RAU PROJECT

0 5 km
UTM ZONE 8W, NAD83; 106D01, 02, 07 & 08

FILE: ...2011

DATE: SEP 2011

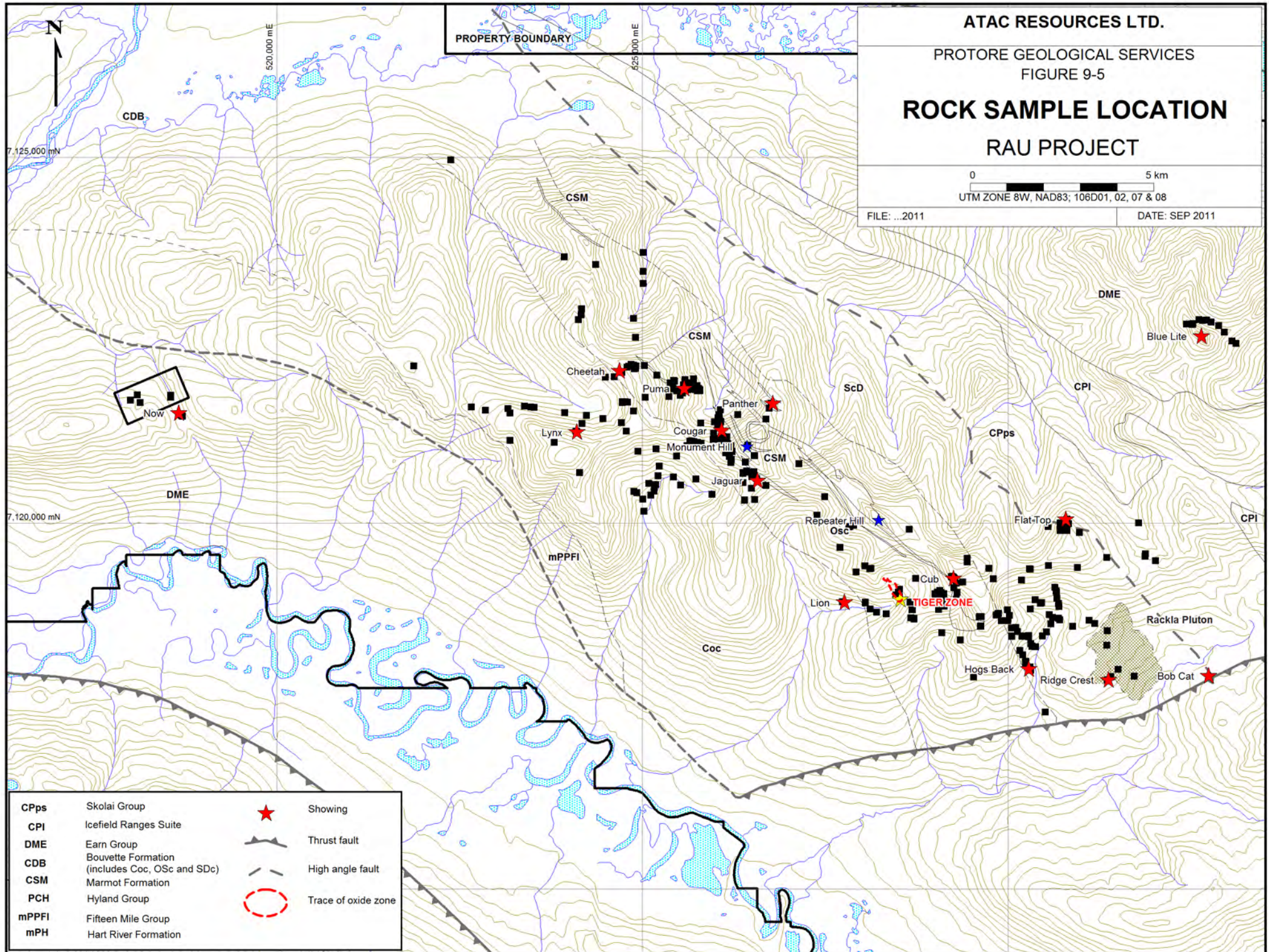

CPps	Skolai Group	★	Showing
CPI	Icefield Ranges Suite	▲	Thrust fault
DME	Earn Group	▬	High angle fault
CDB	Bouvette Formation (includes Coc, OSc and SDc)	○	Trace of oxide zone
CSM	Marmot Formation		
PCH	Hyland Group		
mPPFI	Fifteen Mile Group		
mPH	Hart River Formation		

Rock samples were collected by measured chip samples across mineralized zones. Grab samples were collected from selected mineralized intervals and mineralized float samples. Rock geochemical sample sites on the property were marked with orange flagging tape labeled with the sample number. The location of each sample was determined using a handheld GPS unit. The rock sampled at surface showings is commonly strongly weathered with sulfides oxidized to limonite. This material might be expected to yield higher metal assays than unweathered mineralized samples.

In 2008 additional prospecting ensued following up very strongly anomalous gold-in-soil geochemistry from the 2007 grid soil sampling survey. A total of 54 grab samples were collected mostly from the area of strong gold-in-soil geochemical response which resulted in the discovery of oxide gold mineralization at the Tiger Showing in Tiger Creek. Samples collected from the exposed Discovery Horizon yielded 22.5 g/t gold, >1% arsenic, 415 ppm bismuth and 116 ppm tungsten and 13.6 g/t gold, >1% arsenic, 410 ppm bismuth and 51.9 ppm tungsten. A limonitic float sample taken 90 meters downstream contained 241 g/t silver, 3,730 ppm arsenic, 388 ppm bismuth, 3.27% lead and 2.09% zinc (Dumala, 2009).

Another area of mineralized float (Cub Showing) was found 575 meters to the east of the Tiger Showing. Samples from the Cub Showing returned peak gold values of 1.15 g/t and 1.08 g/t. Neither of these samples had any noteworthy values for other metals. A sample taken from the southeastern edge of this showing contained 18.15 g/t silver, 4,630 ppm lead and >1% zinc. Nine other samples collected from the showing returned 0.98 to 6.54 g/t silver. Three of these samples also contained large amounts of bismuth (1,645 ppm, 1,990 ppm and 6,160 ppm), while most of other samples had >200 ppm. The highest tungsten value at this showing was 233 ppm, from the sample that contained 1,990 ppm bismuth.

The Ridge Showing is a gossan located about 375 meters southeast of the Tiger Showing. A soil sample site within this gossan yielded an exceptionally high gold value (11.65 g/t); but surprisingly the only two rock samples taken in the area returned low gold values. One of these samples, which contained siderite, returned 8.24 g/t silver, 369 ppm lead and 15.95% zinc, while the other yielded >1% arsenic, 36.1 ppm bismuth 92.4 ppm tungsten and 1,285 ppm zinc.

A sample of limonitic vein breccia float collected 1,600 meters southeast of the Tiger Showing in 2006 yielded 1.24 g/t gold, 2.2 g/t silver, 427.9 ppm bismuth and 206.5 ppm tungsten. The sample site is in a heavily vegetated area that has not yet been systematically prospected.

A limonitic float sample was taken along a ridge 650 meters northwest of the Tiger Showing. This sample yielded 1,580 ppm arsenic, 967 ppm lead, 4,760 ppm zinc and 82.6 ppm tungsten, but only 5 ppb gold.

Several more pieces of limonitic float were discovered in a north flowing drainage 5.5 kilometers northwest of the Tiger Showing. This occurrence is known as the Panther Showing. A sample of this material yielded 4.53 g/t silver, 2,900 ppm arsenic, 458 ppm bismuth, 5,760 ppm lead, >1% zinc and 47.7 ppm tungsten. While a second sample, collected 650 meters upstream, returned 8.96 g/t silver, 5,650 ppm arsenic, 275 ppm lead and >1% zinc. Both samples contained less than 16 ppb gold.

Prospecting in 2009 was focused primarily to the northwest up to 13 kilometers along strike from the Tiger Deposit following up gold and arsenic-in-soil geochemical anomalies defined at intermittent locales mainly in the upper regions of the Rau Ridge system. A total of 275 samples were collected of which many returned elevated gold response. The resulting showings/occurrences (Lion, Cub, Jaguar, Panther, Cougar, Puma, Cheetah, Lynx, Now, Blue Lite, Flat Top, Hogs Back and Ridge Crest) defined from this sampling are described in detail in Section 7.4.

In 2010 only a modest amount of additional prospecting was carried out within the same general area as the prospecting conducted in 2009 to follow up a series of ZTEM geophysical anomalies and to better define a number of the previously identified targets in preparation for diamond drilling.

Nine samples of limonite style mineralization were collected from the Condor Showing 8,000 meters northwest of the Tiger Deposit. Five of these samples yielded elevated gold values ranging from 0.53 to 1.50 g/t. An additional four samples were collected from the Puma Showing following up a series of samples collected in 2008 which returned similar assays with one sample yielding 18.45 g/t gold. The 2010 prospecting traced similar limonitic siderite breccia to source where samples collected across steeply dipping structures returned >5 g/t Au across narrow widths between 0.10 and 0.20 meters (Wengzynowski, pers comm., 2010)

9.3 Geological Mapping

Geological mapping was conducted on an ongoing basis between 2007 and 2010 at different locales determined by the focus of that particular exploration season. By 2009, however, the focus of the project was determinately sediment-hosted gold associated with the Tiger Deposit style mineralization and mapping was directed toward defining favorable carbonate rock units and structural settings along the trend of the Rau Ridge system.

Recent 1:50 000 scale geological mapping was compiled over the Rau area by Indian and Northern Affairs Canada in 1990 by Abbott. More detailed mapping was performed by Archer Cathro geologists at 1:20,000 scale with certain areas of interest receiving detailed mapping at 1:1,000 scale. The latter scale mapping was conducted primarily by consultants Dr. Elizabeth Turner and Harry E. Cook. The results are summarized in Section 7.3.

9.4 Geophysics

A variety of airborne and ground geophysical work was carried out over the Rau Ridge system hosting the Tiger Deposit mineralization between 2007 and 2010. Airborne surveys consisted of Vertical Time Domain Electromagnetic (VTEM) and Z axis Tipper Electromagnetic (ZTEM) surveys while ground surveys consisted of Induced Polarization/Resistivity (IP) and Gravity. The airborne surveys covered the entire Rau Ridge system while the ground based surveys were conducted specifically over the Tiger Deposit and isolated VTEM/ZTEM anomalies. In addition to these airborne and ground based surveys, Scintrex Limited was contracted to conduct a specialized Bore-hole Gravity Meter survey in a number of drill holes that intersected significant oxide mineralization for purposes of determining in situ specific gravity.

VTEM: Helicopter-borne magnetic and VTEM surveys were flown over the 64 claims that comprise the core of the Rau Property on August 12, 2008 by Geotech Ltd. of Aurora, Ontario. A total of 135.09 line-kilometers were flown on north-south lines spaced 100 meters apart. The total magnetic data outlined an area of high susceptibility directly over the Rackla Pluton. This high gradually weakens to the west but continues into the area of dykes and sills, suggesting that these tabular intrusions may coalesce with the Rackla Pluton to form a larger body at depth. Strings of weaker magnetic highs in the western part of the survey area are closely correlated magnetic volcanic horizons correlative with Units E, F and G.

Additional VTEM surveys were completed over the rest of the Rau Ridge system in two phases on July 14 and 15 and between August 13 and September 23, 2008 by Geotech Ltd. of Aurora, Ontario. In total, 2,994 line-kilometers were flown on north-south lines spaced 100 meters apart. The preliminary total magnetic and electromagnetic data outlined a strong, 23.5 kilometer long, northwest trending linear feature originating near the Rackla Pluton.

In spring 2009, Condor Consulting Inc., was retained to complete processing, analysis and interpretation of EM and magnetic data obtained from VTEM surveys completed in 2007 and 2008. Condor's work outlined a series of conductive units originating from the Tiger Deposit and extending approximately 15 kilometers northwest along trend (Figure 9-6). Many of these conductors parallel the property extensive shear zone believed to be associated with the fluid conduit localizing gold at the Tiger Deposit. An approximately 25 kilometer long linear magnetic high, corresponding to the Marmot Formation volcanic units can be traced through the center of the property. Typically, conductors can be found along the south side of this magnetic feature.

ATAC RESOURCES LTD.

PROTORE GEOLOGICAL SERVICES

FIGURE 9-6

MODELLED VTEM ANOMALIES

RAU PROJECT

0 5 km

UTM ZONE 8W, NAD83; 106D01, 02, 07 & 08

FILE: ...2011

DATE: SEP 2011

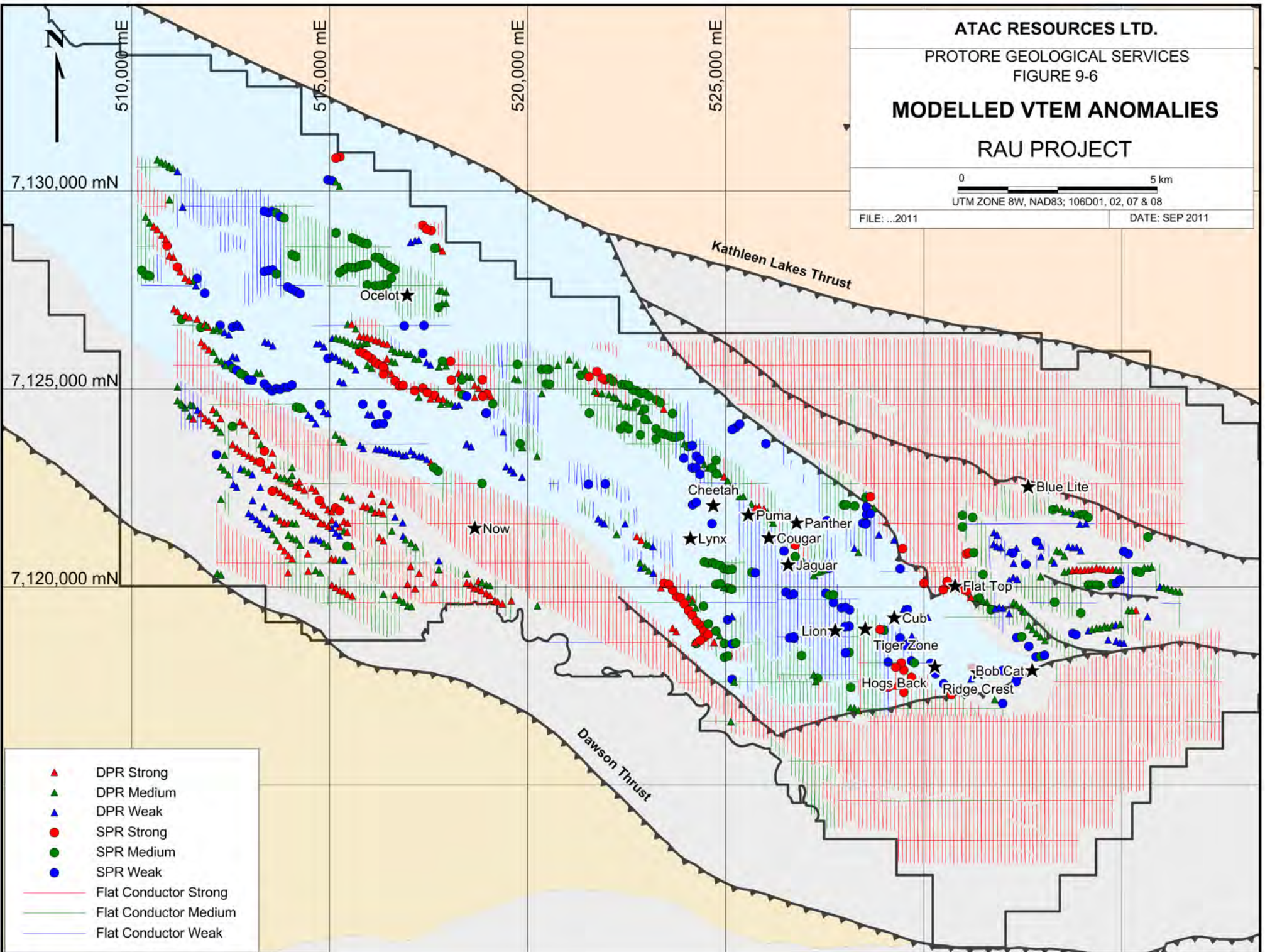

ZTEM: In late spring 2010, Geotech Ltd. was contracted to complete two helicopter-borne ZTEM and aeromagnetic geophysical surveys over the Rau Property. The initial survey was conducted between May 27 and June 6, and comprised 331 line-kilometers, while the second survey was completed between June 14 and June 22 and totaled 3,018.6 line-kilometers which included the area covering the Rau Ridge system.

Strings of ZTEM conductors were identified throughout the Rau Property many of which correspond with the VTEM conductors. A number of new anomalies were also identified a short distance from the Tiger Deposit with similar geophysical signatures which were the focus of some of the 2010 exploration. Figure 9-7 illustrates the extent of the ZTEM survey and the associated anomalies identified within the vicinity of the Rau Ridge system

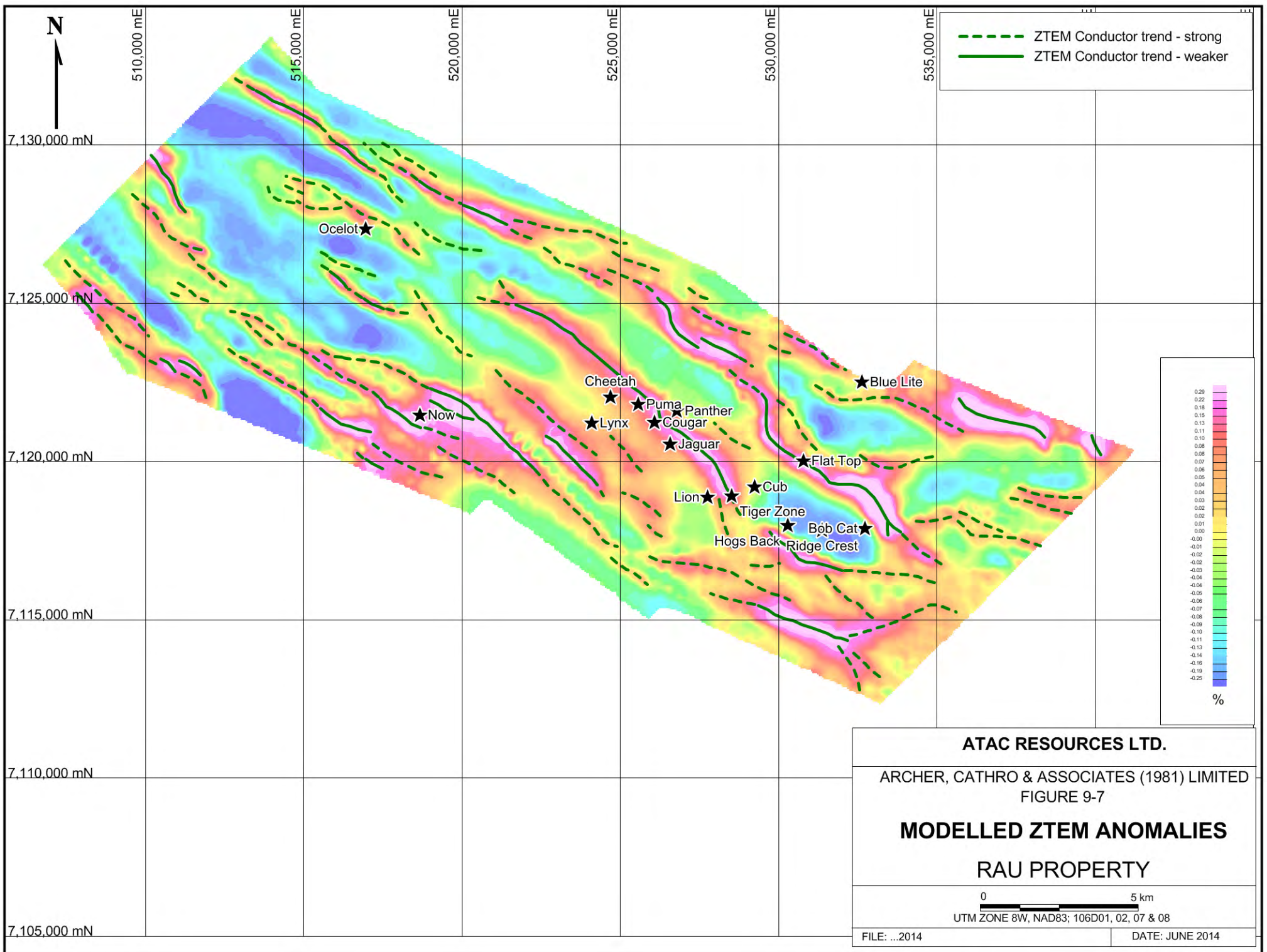

IP/Resistivity: A modified ground pole-dipole IP survey was completed at the Tiger Deposit by Aurora Geoscience of Whitehorse. The survey was done using a four person crew based out of a lodge located north of Mayo between August 4 and 13, 2009. Three lines, totaling 4.2 line-kilometers corresponding to section lines 10+400NW, 10+120NW and 09+650NW were tested by this survey.

On section line 10+400NW, a well-defined chargeability high is located to the southwest of the baseline. The lower portion of this anomaly would have been pierced by hole Rau-09-52, which intersected unmineralized, brecciated limestone in this area. Unfortunately noise on section line 10+120NW made interpretation at depth near the massive pyrite intersection in hole Rau-08-18 unusable. Only the near surface data (<100 meter) was usable in the area of interest. On section line 09+650NW, the chargeability high is located at surface at 10+1000NE and dips to the northeast at approximately 45°.

Gravity: In June 2011, MWH Geo-Surveys, Inc. completed ground gravity surveys over three grids along the Rau Ridge system. These grids were located over the Tiger Deposit, Condor and Puma showings. At the Puma Showing, a linear, north trending gravity high is defined along the western edge of the grid, near the ridgeline. No significant anomalies were identified at the Tiger Deposit or Condor Showing.

10.0 DRILLING

The following italicized portions of section 10.0 of this report, **DRILLING**, are taken verbatim from Stroshein (Protore Geological Services) et.al. from the previously published NI 43-101 Technical Report, dated November 15, 2011.

The mineral resource discussed in this report was determined using the data provided by diamond drilling completed by ATAC between 2008 and 2010. Figure 10-1 illustrates the drill hole locations utilized for the determination of the mineral resource.

Drilling at the Tiger Deposit has defined potentially economic gold mineralization in numerous drill holes that have delineated a cohesive oxide and sulfide zone from surface to 250 meters depth. This mineralization is confined to a single horizon that has been structurally displaced near Tiger Creek. The structural displacement also defines the boundary between oxide dominant and sulfide dominant portions of the mineralized system. The limits of the mineralization are not fully delineated along strike or down dip and there is evidence that suggests that there are potential mineralized horizons occur in a stacked nature above and beneath the Tiger Deposit Discovery Horizon.

A total 25,562.5 meters of exploration and definition drill holes were completed through 2010 and evaluated for use in the Tiger Deposit resource estimation (Table 10-1). Down hole drill depths range from 5 to 593.25 meters with an average depth of 192.2 meters. This drilling was completed on a nominal 50 meter spaced grid over the main area of interest with portions of the oxide mineralization being drilled at 25 to 30 meter spacing. The drill sections are all oriented northeast-southwest.

Table 10-1
Tiger Deposit Mineral Resource Database Summary

<i>Year</i>	<i>Holes Drilled</i>	<i>Total Drilled (m)</i>
<i>2008</i>	<i>19</i>	<i>3,516.85</i>
<i>2009</i>	<i>53</i>	<i>8,651.2</i>
<i>2010</i>	<i>61</i>	<i>13,394.4</i>
Total	133	25,562.45

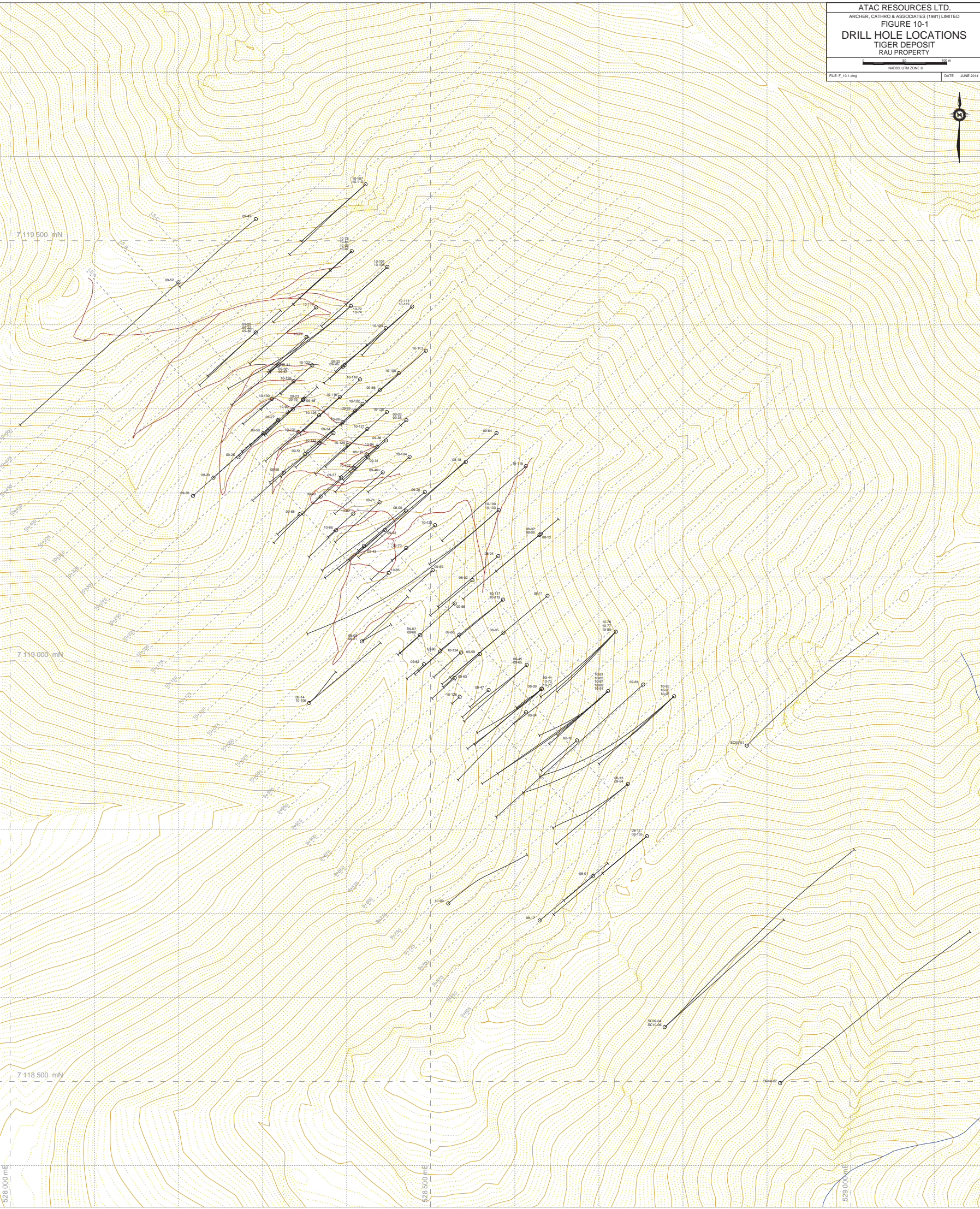

The Tiger Deposit is a thick northwesterly trending body of carbonate replacement style gold mineralization hosted by a moderately northeast dipping horizon. It is currently 700 meters long, 100 to 200 meters wide and up to 96 meters thick. Mineralization is developed within and adjacent to a regionally extensive corridor of highly strained rocks that are manifested as a 40 to 150 meter wide zone of small scale folding and shearing. The geometry of the mineralized system is defined by a series of stacked and folded limestone horizons intercalated with locally extensive mafic flows and volcanoclastic units. Examples of this geometry are illustrated within sections on Figures 10-2 and 3.

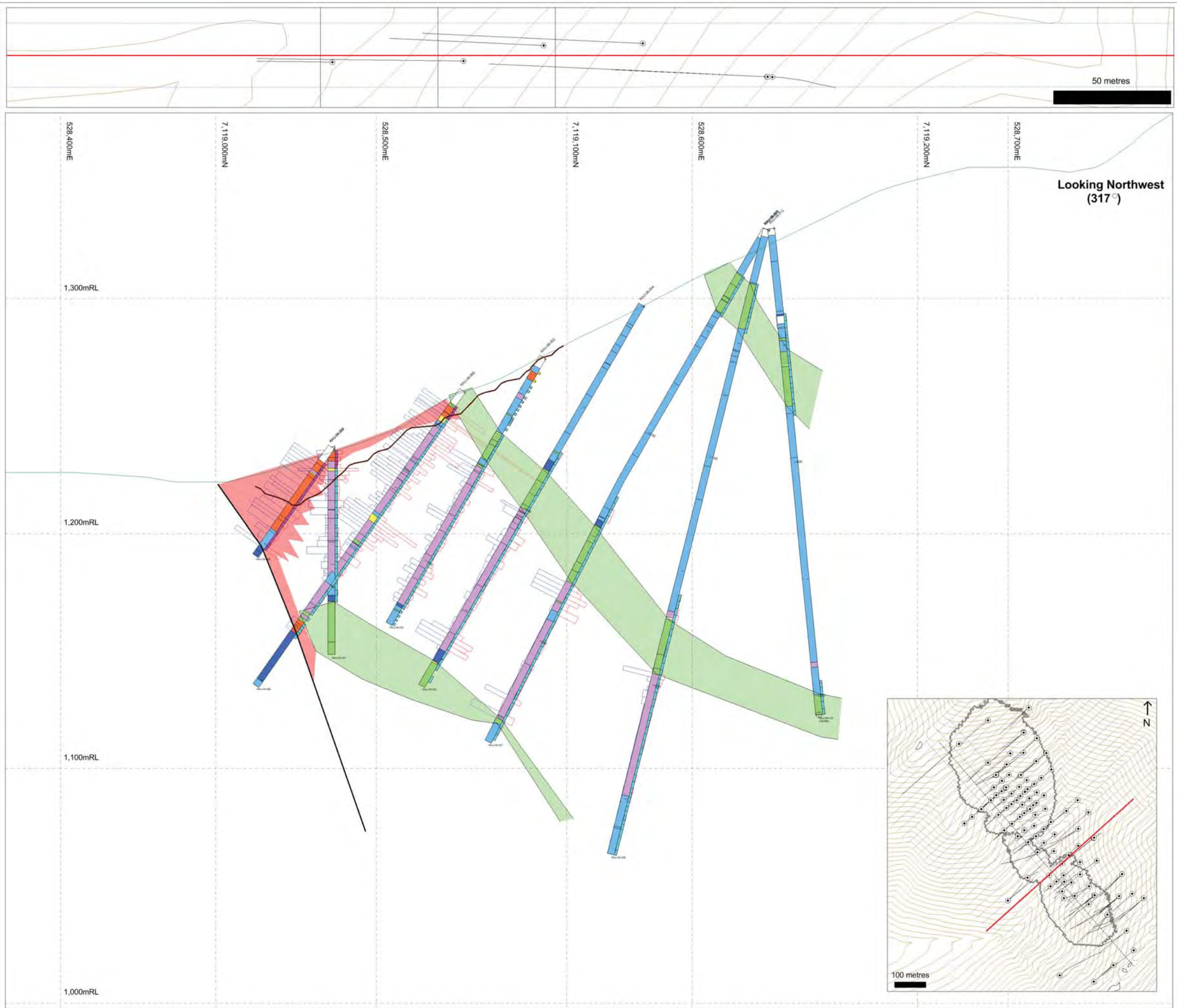

- Legend**
- GEOLOGY**
- Overburden
 - Limestone
 - Dolomite
 - Marble
 - Volcaniclastic
 - Iron oxide
 - Tiger fault
 - North-trending extensional fault
 - PEA pit shell
- OXIDATION STATE**
- Fresh
 - Transitional
 - Oxidized
- MINERALIZATION**
- Gold
Scale: 1 mm = 1 g/t
Max value capped at 50 g/t
 - Arsenic
Scale: 1 mm = 4,000 ppm
Max value capped at 50,000 ppm
 - Significantly mineralized iron oxide

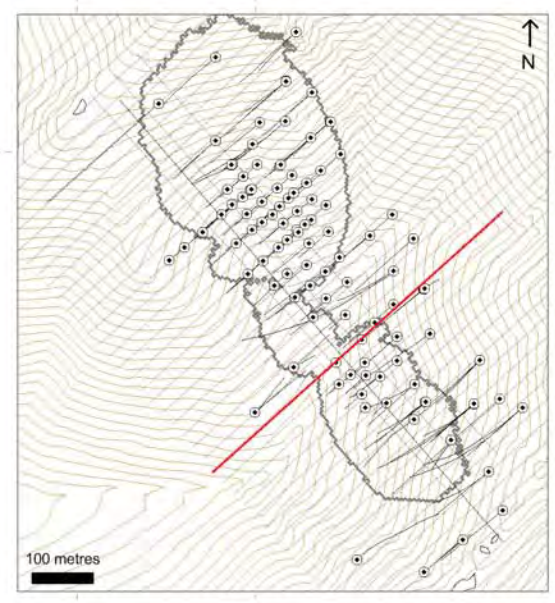

Section represents a 25 metre envelope

ATAC RESOURCES LTD.

Figure 10-2
 ARCHER, CATHRO & ASSOCIATES (1981) LIMITED
TIGER SECTION 10+000
 RAU PROPERTY

0 m 10 m 20 m 30 m 40 m 50 m
 NAD 83 ZN 8 Scale 1:1000

Rau_ARCHC wor JUNE 2014

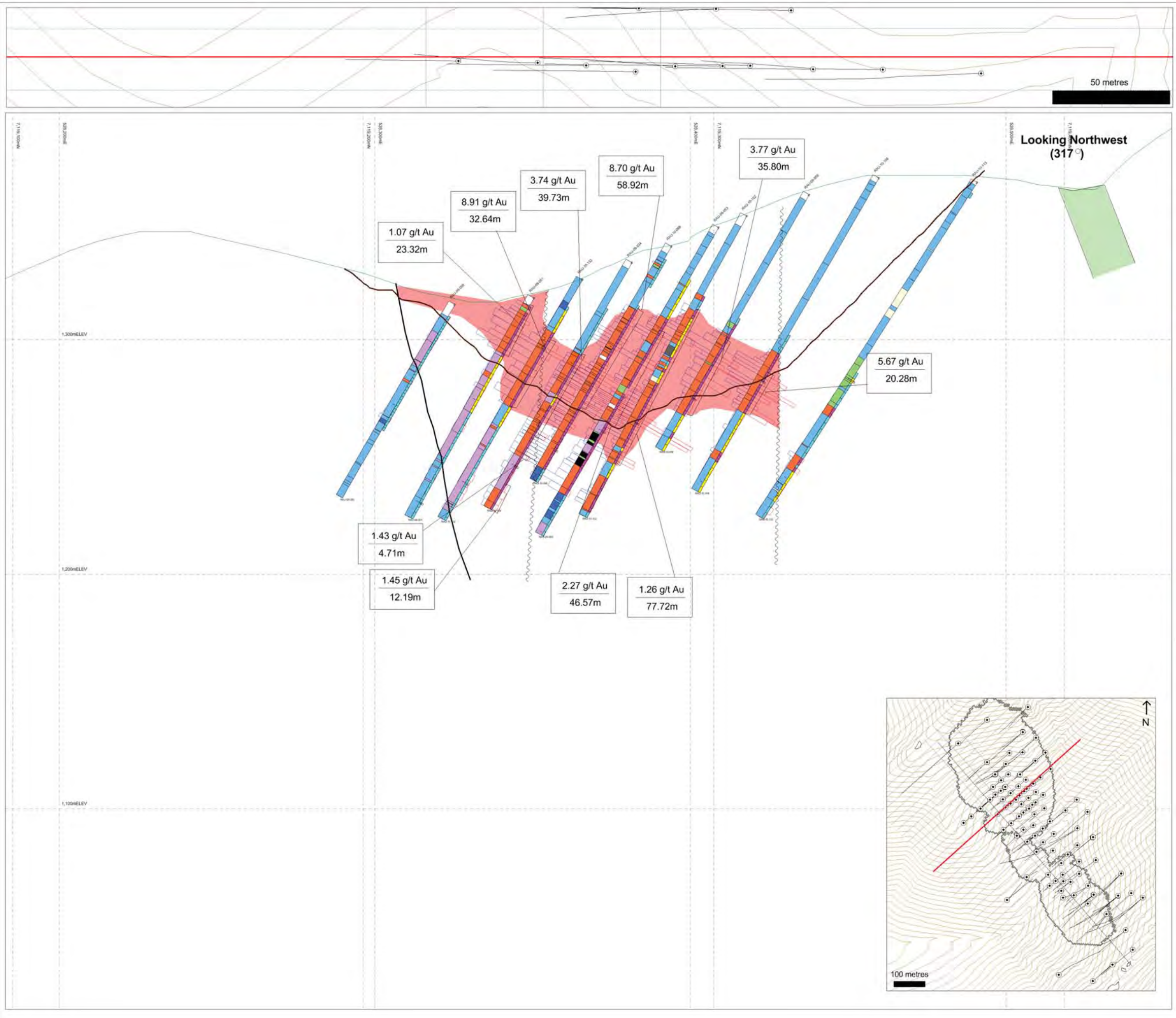

Legend

GEOLOGY

- Overburden
- Limestone
- Dolomite
- Marble
- Volcaniclastic
- Iron oxide
- Tiger fault
- North-trending extensional fault
- PEA pit shell

OXIDATION STATE

- Fresh
- Transitional
- Oxidized

MINERALIZATION

- Gold
Scale: 1 mm = 1 g/t
Max value capped at 50 g/t
- Arsenic
Scale: 1 mm = 4,000 ppm
Max value capped at 50,000 ppm
- Significantly mineralized iron oxide

Section represents a 25 metre envelope

ATAC RESOURCES LTD.

Figure 10-3
 ARCHER, CATHRO & ASSOCIATES (1981) LIMITED
TIGER SECTION 10+250
 Rau Property

0 m 10 m 20 m 30 m 40 m 50 m
 NAD 83 ZN 6 Scale 1:1000
 Rau_ARCHC.wor JUNE 2014

Gold occurs in both sulfide and oxide facies mineralization. Sulfide mineralization is accompanied by, and developed within, limestone that is replaced by ferruginous dolomite and iron carbonate minerals. Sulfide species consist of disseminated to banded pyrite, with subordinate arsenopyrite and pyrrhotite and minor bismuthinite and sphalerite. Small amounts of disseminated scheelite are also present. The main sulfide minerals exhibit at least three stages of mineralization. The best intersection from sulfide bearing mineralization averaged 4.04 g/t gold over 96.0 meters true width from hole Rau-09-66.

Oxide mineralization is completely devoid of sulfide minerals and ranges from very competent, weakly porous limonitic mud to rubbly porous limonitic grit. The oxide appears texturally amorphous within most intersections but occasionally exhibits residual color banding that may represent relict sulfide textures. Complete oxidation extends up to 150 meters from surface. The best oxide grades (e.g. hole Rau-09-19 which assayed 24.07 g/t gold across 28.0 meters true width) and deepest oxidation occur where northerly trending extensional faults intersect the regional structure. The nature of the contacts between the oxide and sulfide facies is poorly understood, as is the gold distribution within the mineralized horizon and within individual sulfide species.

Figure 10-4 illustrates the gold g/t x meter plot which distinctly defines and segregates the oxide mineralization and the sulfide mineralization.

ATAC RESOURCES LTD.

ARCHER, CATHRO & ASSOCIATES (1981) LIMITED
FIGURE 10-4

TIGER DEPOSIT

Gold Gram x Metre Plot

RAU PROPERTY

FILE:2014/RAU

DATE: JUNE 2014

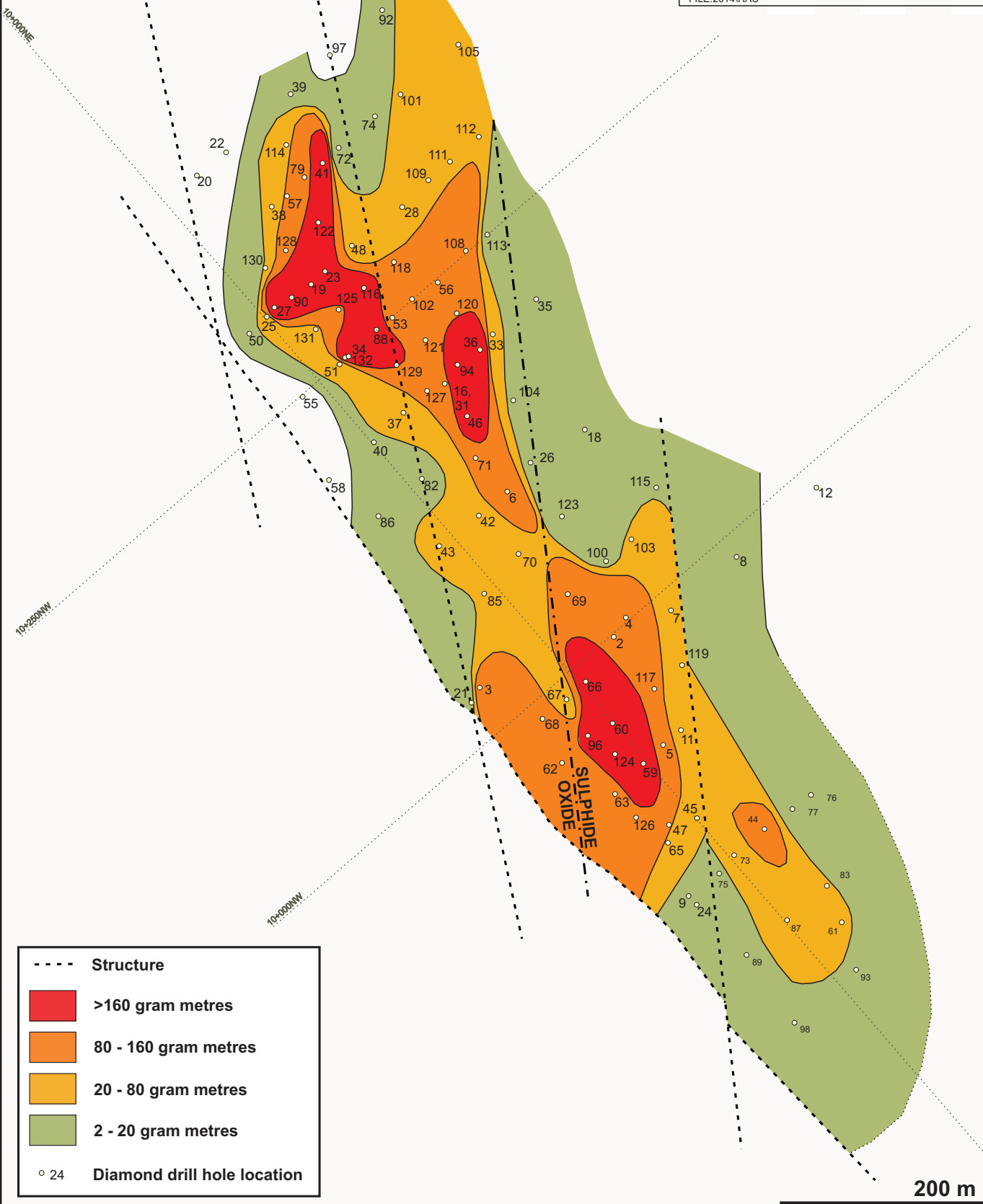

----	Structure
	>160 gram metres
	80 - 160 gram metres
	20 - 80 gram metres
	2 - 20 gram metres
○ 24	Diamond drill hole location

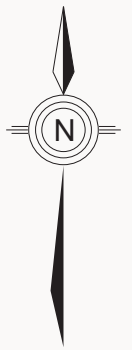

200 m

10.1 Diamond Drilling Specifications

All drill campaigns were contracted to Superior Diamond Drilling of Kelowna, BC which conducted all work within the deposit on behalf of ATAC.

During 2008 diamond drilling at the Rau Property was completed with a Mandrill 1200 diesel-powered drill using BTW equipment yielding core diameters 4.17 centimeters. In 2009, drilling was performed with a Mandrill 1200 and two B-15 diesel-powered drills using BTW (4.17 centimeter core diameter), NQ2 (5.06 centimeter core diameter) and HQ3 (6.11 centimeter core diameter) equipment. The same equipment was used among the three drills in 2010 with the addition of a track mounted mobilization system on one of the B-15 drills and the ability to utilize PQ (8.50 centimeter core diameter) tooling.

Different diameter tooling was used in certain parts of the mineralizing system as the effectiveness of certain diameters was determined throughout the evolution of the exploration campaigns. BTW tooling was considered efficient from a recovery perspective within the sulfide portion of the deposit while NQ2 and HQ3 were the best means of properly testing the oxide parts of the mineralizing system to maximize recovery. PQ size holes were drilled as infill and twinned holes from earlier campaigns to evaluate the effects of larger diameter core diameter with respect to recovery and continuity of gold grade.

10.2 Core Logging and Collar Surveys

Core logging started very basic in 2008 using a generic logging form that was filled out in hardcopy form during the day and entered digitally during the evening. As the project evolved a site specific core assessment manual with a project specific drill log was created for the Rau Property and included fields for rock type and modifiers for lithology, minerals, alteration, textures, structure, hardness, weathering and concentrations. Where oxide was logged, a Munsel color chart was utilized to characterize color for maximum continuity.

Drill core samples were collected using the following procedures:

- Core was lightly washed and measured.*
- Core was geotechnically logged.*

- Core was geologically logged and sample intervals were designated. Sample intervals were set at geological boundaries, drill blocks or sharp changes in sulfide/oxide content.
- Core recovery was calculated for each sample interval.
- Sample intervals were based on sulfide/oxide content.
- Core was sawn or split in half depending on the type of mineralization encountered. Oxide was generally split with the impact splitter to avoid washing away potential gold bearing material. One-half was sent for analyses and one-half returned to the core box.
- Samples were double bagged in 6 millimetre plastic bags, a sample tag was placed in each sample bag, then two (2) or three (3) samples were placed in a fiber glass bag sealed with a metal clasp and sample numbers were written on the outside of that bag with permanent felt pen.
- Two (2) blank and two (2) standard samples were randomly included in every batch of 31 core samples.
- Duplicate samples were collected by quartering sample intervals after the initial half split in every batch of 31 core samples.

A separate Geotechnical Log was filled out prior to geological logging and included the conversion of drill marker blocks from imperial to metric and determinations of recovery, rock quality designation (RQD) hardness and weathering. Wetted core photographs were taken prior to logging photographing three boxes at a time from a common marker to provide the same field of view for each photo taken. These photos were then catalogued for historical reference.

Sulfide mineralization and unoxidized intervals within the oxide zone were collected for “field-based” density measurements used both wet and dry evaluation methods to provide base level density data for resource evaluation. Magnetic susceptibility logs were also created where measurements were collected at one meter intervals along the entire hole.

All logging data was collected by means of hardcopy during the day and transcribed to digital format during the evenings or by designated personnel the next day.

The drill hole collars were surveyed by Archer Cathro employees using a Trimble real time kinematic GPS. Collars are marked by scrap drill rods cemented into the hole and a steel tag showing the hole number.

All down-hole surveys were conducted with the use of a “Ranger Explorer” magnetic multi-shot tool provided by Ranger Survey Systems. Shots were taken every 50 feet in the hole recording Azimuth, Inclination, Temperature, Roll Angle (Gravity and Magnetic) plus Magnetic Intensity, Magnetic Dip and Gravity Intensity (for quality assurance). The tool uses a landing collar that sits in the bit and aluminum extension rods to ensure that the tool is hanging beneath the rod string (about 20’) away from any magnetic interference.

All readings were reviewed and erroneous data (magnetic and/or gravity intensity were outside the normal range, or other obviously incorrect readings) were not used when plotting the final hole traces.

11.0 SAMPLE PREPARATION, ANALYSIS AND SECURITY

The following italicized portions of Section 11.0 of this report, **SAMPLE PREPARATION, ANALYSIS AND SECURITY**, are taken verbatim from Stroshein (Protore Geological Services) et.al. from the previously published NI 43-101 Technical Report, dated November 15, 2011.

This section describes the sample procedures followed during the diamond drilling exploration programs supervised and described by Archer Cathro for ATAC. The authors have reviewed the methods and approaches where described in the recent assessment reports and have discussed the processes in detail with the supervising geologist. Also described are sample handling procedures followed during the exploration programs managed by Archer Cathro for ATAC. A project specific sample handling manual was designed in conjunction with the field operations manual specific to core processing.

Soil samples were transported from the Property to Whitehorse in the custody of Archer Cathro employees. From there, they were shipped to ALS Canada (“ALS”) laboratory in North Vancouver. At the lab, soil samples were dried and screened to -35 mesh to produce a fine fraction, which was then pulverized to 85% passing 75 microns. Splits of the pulverized fraction were routinely dissolved in aqua regia and analyzed for 35 elements using the ICP-AES technique (ME-ICP41). All samples were also analyzed for gold using fire assay and ICP-AES (Au-ICP21).

Surface rock and core samples were flown by helicopter from the Property to a staging area at McQuesten Lake, then transported to Whitehorse by truck, escorted by a representative of Archer Cathro. The samples were shipped from Whitehorse to ALS. Core samples were dried and crushed to 70% minus 2 millimeters, before a 1.5 kilogram split was taken and pulverized to better than 85% minus 75 microns. To reduce cross contamination between samples during preparation, the equipment was washed twice with quartz silica sand. Splits of the pulverized fraction were routinely dissolved in aqua regia and analyzed for 48 elements using technique ME-MS61, which combined inductively coupled plasma (ICP) with mass spectroscopy (MS) and atomic emission spectroscopy (AES). Samples were analyzed for gold by fire assay finished with atomic absorption spectroscopy (Au-AA26).

Core recovery was excellent in the sulfide portion of the Tiger Deposit averaging 98%. Recovery of the oxide mineralization was very poor during the 2008 drill season but

rapidly improved in 2009 and 2010 with the use of larger core diameter tooling and superior mud technology. All mineralized drill core was split/sawn for assay. The mineralization is readily recognizable by sulfide /oxide content in the core. It is the opinion of the authors that the drill core sampling is reliable and is representative of the mineralization with the Tiger Deposit.

The samples collected from the project were controlled by employees of Archer Cathro until delivered to a commercial carrier or directly to the laboratory facilities. ALS Canada is an independent commercial laboratory. ALS has ISO 9001:2000 certification.

Core was transported by helicopter from the drill sites to a logging area on the Property, where recovery was measured and geological and geotechnical logging was performed. Geologically and mineralogically favorable intervals from each hole were split with one-half bagged and sent for analysis and the other half returned to the core box. All cores are stored on the Property.

Prior to 2008 no drilling was conducted on the Property and QAQC for soil sample and rock sample processing utilized standard industry procedures. More robust protocols used for the diamond drilling between 2008 and 2010 are discussed below.

QAQC 2008

During the program 35 gold standards and 42 blanks were inserted within the sample sequences. The standard material was obtained from CDN Resource Laboratories Ltd. ("CDN") (gold ore reference standard CDN-GS-15A), which has a consensus value of 14.83 ppm gold. The acceptable (two standard deviation) error in the sampling is ± 0.61 ppm.

Gold values from all but one of the blank samples were within acceptable range (< 0.05 ppm). The failed sample was from hole Rau-08-07 and returned 0.14 ppm. All samples from this hole were reanalyzed by the laboratory to ensure the results were accurate.

All but nine of the standard sample values were within the acceptable range. Gold values from four of the sample batches (Rau-08-07, -08, -09 and -11) that included failed standards were reanalyzed by the laboratory to ensure results were accurate. Most results from the reanalysis were relatively consistent when compared with the original values. The most notable exceptions were three samples from Rau-08-07, which returned values significantly higher than the original. These samples first yielded 6.71, 4.39 and

5.67 ppm. Results from the reanalysis were 8.32, 5.69 and 7.84 ppm respectively. The following table shows the results of the analysis for the standard samples.

Table 11-1
2008 Quality Control Samples

<i>Hole</i>	<i>Sample</i>	<i>Gold (ppm)</i>
<i>Rau-08-01</i>	<i>G004539</i>	<i>14.7</i>
<i>Rau-08-02</i>	<i>G004541</i>	<i>14.3</i>
<i>Rau-08-02</i>	<i>G004561</i>	<i>14.8</i>
<i>Rau-08-02</i>	<i>G004581</i>	<i>>10.0*</i>
<i>Rau-08-02</i>	<i>G004602</i>	<i>>10.0*</i>
<i>Rau-08-03</i>	<i>G004838</i>	<i>14.55</i>
<i>Rau-08-04</i>	<i>G004755</i>	<i>13.3</i>
<i>Rau-08-04</i>	<i>G004774</i>	<i>14.25</i>
<i>Rau-08-05</i>	<i>G004808</i>	<i>14.4</i>
<i>Rau-08-05</i>	<i>G004823</i>	<i>14.45</i>
<i>Rau-08-06</i>	<i>G004862</i>	<i>NSS*</i>
<i>Rau-08-06</i>	<i>G004879</i>	<i>15.2</i>
<i>Rau-08-07</i>	<i>H246016</i>	<i>9.74</i>
<i>Rau-08-07</i>	<i>H246029</i>	<i>12.95</i>
<i>Rau-08-07</i>	<i>H246251</i>	<i>13.7</i>
<i>Rau-08-08</i>	<i>H246046</i>	<i>13.8</i>
<i>Rau-08-08</i>	<i>H246066</i>	<i>14.5</i>
<i>Rau-08-08</i>	<i>H246074</i>	<i>14.35</i>
<i>Rau-08-09</i>	<i>H246124</i>	<i>14.05</i>
<i>Rau-08-09</i>	<i>H246140</i>	<i>13.65</i>
<i>Rau-08-10</i>	<i>H246159</i>	<i>15.35</i>
<i>Rau-08-10</i>	<i>H246170</i>	<i>14.65</i>
<i>Rau-08-11</i>	<i>H246198</i>	<i>13.4</i>
<i>Rau-08-11</i>	<i>H246223</i>	<i>13.25</i>
<i>Rau-08-12</i>	<i>H246239</i>	<i>15.2</i>
<i>Rau-08-13</i>	<i>H246276</i>	<i>15.2</i>
<i>Rau-08-13</i>	<i>H246297</i>	<i>14.85</i>
<i>Rau-08-14</i>	<i>H246577</i>	<i>14.75</i>
<i>Rau-08-15</i>	<i>H246604</i>	<i>14.65</i>
<i>Rau-08-16</i>	<i>H246618</i>	<i>15.45</i>
<i>Rau-08-16</i>	<i>H246634</i>	<i>14.5</i>
<i>Rau-08-18</i>	<i>H246717</i>	<i>13.5</i>
<i>Rau-08-18</i>	<i>H246753</i>	<i>14.35</i>
<i>Rau-08-18</i>	<i>H246773</i>	<i>15.05</i>
<i>Rau-08-18</i>	<i>H246791</i>	<i>14.55</i>

**sample size not sufficient to obtain complete assay result*

QAQC-2009

During the 2009 field season, samples were divided into batches, each containing 31 core samples, two standards, two blanks and one duplicate. A total of 155 standards and 151 blanks were inserted into the sample sequences. Blank samples each comprised 4 kilograms of landscaping marble obtained from a garden centre in Whitehorse. Samples of this material were randomly selected and analyzed prior to the field season in order to use as certified blank material.

Prior to the field season, three standard samples were prepared by CDN from core collected in 2008. Two additional gold standards, obtained from CDN and a tungsten standard from the Canada Centre for Mineral and Energy Technology were used for check analysis performed following the field season. Table 11-2 summarizes the consensus and two standard deviation values for each of the standard samples used during the program.

Table 11-2
2009 Standard Sample Consensus Values

Sample	Consensus Value	2δ
STD-1	0.514 g/t Au	0.058
STD-2	1.527 g/t Au	0.134
STD-3	5.705 g/t Au	0.498
CDN-GS-1D	1.05 g/t Au	0.10
CDN-GS-3F	3.10 g/t Au	0.24
BH-1	0.422% W	0.008

Gold values from all but five of the blank samples were within acceptable range (≤ 0.05 ppm). The failed samples were from batches 1 (0.15 g/t), 35 (0.06 g/t and 0.13 g/t), 53 (0.23 g/t) and 55 (0.08 g/t). All samples from batch 35 were reanalyzed by the laboratory to ensure the results were accurate. The remaining samples were found to be within ALS's accepted "carry-over" limit given the high gold values of the proceeding samples.

All but nine of the standard sample values are within the acceptable range. Gold values from seven of the sample batches (5, 23, 39, 46, 52, 68 and 76) that included failed standards were reanalyzed by the laboratory to ensure results were accurate. Results from the reanalysis were typically consistent with the original values. The most notable variations came from thirteen samples with values greater than 1.5 g/t gold, suggesting a small nugget effect occurs with higher grade samples.

A total of 76 duplicate samples, prepared from quarter core, were collected and analyzed throughout the program. In general, there was a small decrease in gold values but otherwise little variation between the initial and duplicate samples. The most notable difference was from hole Rau-09-19. The initial sample yielded 162.00 g/t, while the duplicate returned 84.50 g/t. This implies that there is some nugget effect present, particularly in the higher grade samples. The smaller size of the duplicate sample may also account for the general decrease in gold grade in these samples.

In December 2009, 132 pulps and 137 coarse rejects were randomly selected from the 2,359 core samples collected that summer. In order to remove any bias, pulps and coarse rejects were selected from a Microsoft Excel spreadsheet using a random number generator. These samples were renumbered and submitted to ACME Analytical Laboratories (“ACME”) in Vancouver, B.C. for reanalysis for gold and tungsten.

At ACME, coarse reject material was pulverized to better than 85% minus 75 microns. Equipment was washed twice with glass between samples to reduce the possibility of cross contamination. A 50 gram split was taken and analyzed for gold by fire assay and finished with atomic inductively coupled plasma (ICP) with emission spectroscopy (ES). Tungsten was analyzed using the Group-7KP technique, which dissolves the sample in phosphoric acid and completes the analysis using a combination of inductively coupled plasma (ICP) and emission spectroscopy (ES).

These samples were arranged in batches of 35 samples and include two standard samples per batch. Two blank samples were also included in each batch of coarse rejects. Table 11-3 lists the results of these QAQC samples.

Table 11-3
2009 ACME QAQC Standard and Blank Samples

Batch	Standard	Sample	Au (g/t)	W (%)
Reject-1	Blank	E687006	<0.01	<0.005
Reject-1	BH-1	E687010		0.435
Reject-1	STD-3	E687015	5.53	
Reject-1	Blank	E687034	<0.01	<0.005
Reject-2	BH-1	E687044	0.04	0.423
Reject-2	Blank	E687051	0.02	<0.005
Reject-2	Blank	E687056	<0.01	<0.005
Reject-2	STD-1	E687063	0.48	
Reject-3	Blank	E687082	0.02	<0.005
Reject-3	Blank	E687083	0.01	<0.005
Reject-3	STD-2	E687084	1.43	
Reject-3	STD-1	E687100	0.47	
Reject-4	Blank	E687110	<0.01	<0.005
Reject-4	BH-1	E687118		0.417
Reject-4	Blank	E687124	0.01	<0.005
Reject-4	STD-1	E687125	0.5	
Reject-5	STD-2	E687145	1.5	
Reject-5	Blank	E687148	<0.01	<0.005
Reject-5	Blank	E687152	15.55	<0.005
Reject-5	STD-1	E687157	0.48	
Pulp-1	BH-1	E687168		0.427
Pulp-1	GS-3F	E687183	2.77	
Pulp-2	GS-3F	E687202	2.97	
Pulp-2	GS-1D	E687222	1.04	
Pulp-3	GS-1D	E687246	1.12	
Pulp-3	GS-1D	E687252	1.07	
Pulp-4	GS-3F	E687268	3.05	
Pulp-4	BH-1	E687279		0.415

One standard and one blank sample did not meet the QAQC criteria. The standard sample (E687010) returned the maximum allowable value before resulting in an automatic failure. Blank sample E687152 yielded 15.55 g/t gold. Despite a maximum allowable carry-over of 1% from the preceding sample (41.20 g/t) this sample was a clear failure.

The blank samples consisted of coarse marble aggregate and first needed to be crushed to 70% passing two millimeters. Because these samples had to be removed from the sample stream to accommodate this extra step, it is not clear as to where the contamination would have occurred and whether or not other samples could have been affected.

On average, gold results were similar to the original analytical results. The greatest variability occurs in samples that initially yielded greater than 10.0 g/t gold. Of the 269 pulp and coarse reject samples reanalyzed, 191 returned gold values within 0.10 g/t of the original, 33 samples increased by more than 0.10 g/t and 46 decreased by more than 0.10 g/t. In general, tungsten results from ACME were higher than the original ALS results. A total of 157 samples returned tungsten values below the detection limit and are consistent with the original values. Of the remaining 112 samples, 90 yielded values greater than the original. The greatest increase came from a sample that originally returned 1,320 ppm tungsten, which increased to 1,870 ppm tungsten. The general increase can be explained by the more complete digestion of the sample using the Group-7KP analytical technique.

QAQC - 2010

During the 2010 field season, samples were divided into batches, each containing 31 core samples, two standards, two blanks and one duplicate. Blank samples comprised landscaping marble obtained from a garden centre in Whitehorse. The weight of each blank sample was determined based upon the core diameter of the surrounding samples. Blank weight for BTW, NQ, HQ and PQ were four, five, seven or eight kilograms, respectively. Several tons of this material was obtained prior to the start of the exploration season and laid out in conical pile within a “sterile” environment where it was thoroughly mixed. Eight equally spaced channels were sampled from the base of the pile to the apex and analyzed by ALS and ACME prior to the field season in order to use as certified blank material.

Prior to the field season, four sulfide standard were prepared from the 2009 Tiger Deposit core reject material by CDN. Four oxide standard samples were purchased from Geostats Pty Ltd. Table 11-4 summarizes the consensus and two standard deviation values for each of the standard samples used during the program.

Table 11-4
2010 Standard Sample Consensus Values

<i>Standard</i>	<i>Sample</i>	<i>Consensus Value</i>	<i>2δ</i>
<i>ROS-1</i>	<i>G306-1</i>	<i>0.41 g/t Au</i>	<i>0.06</i>
<i>ROS-2</i>	<i>G399-2</i>	<i>1.46 g/t Au</i>	<i>0.18</i>
<i>ROS-3</i>	<i>G999-4</i>	<i>3.02 g/t Au</i>	<i>0.42</i>
<i>ROS-4</i>	<i>G306-3</i>	<i>8.66 g/t Au</i>	<i>0.66</i>
<i>RSS-5</i>	<i>2010-A</i>	<i>0.437 g/t Au</i>	<i>0.048</i>
<i>RSS-6</i>	<i>2010-B</i>	<i>1.83 g/t Au</i>	<i>0.21</i>
<i>RSS-7</i>	<i>2010-C</i>	<i>3.83 g/t Au</i>	<i>0.33</i>
<i>RESS-8</i>	<i>2010-D</i>	<i>2.72 g/t Au</i>	<i>0.35</i>

In 2010 gold values from all but five of the blank samples were within acceptable range (≤ 0.05 ppm). The failed samples were from batches 12 (0.06 g/t), 31 (0.10 g/t), 42 (0.16 g/t), 73 (0.08 g/t) and 104 (0.38 g/t). New master pulps were created for all samples in batches 73 and 104 and were reanalyzed to ensure the results were accurate. The remaining samples were found to be within ALS's accepted "carry-over" limit given the high gold values of the proceeding samples.

All but ten of the standard sample values were within the acceptable range. Gold values from the sample batches (2, 5, 9, 14, 33, 45, 58, 93, 85 and Cheetah 7) that included failed standards were reanalyzed by the laboratory to ensure results were accurate. Results from the reanalysis were typically consistent with the original values.

A total of 117 duplicate samples, prepared from quarter core, were collected and analyzed throughout the program. In general, there was little variation in gold values between the initial and duplicate samples. On average the duplicate samples show a 13% increase in gold grade over the original sample. The most notable differences come from low grade samples where even a minor increase in grade translates to a significant percentage gain.

The quality control program indicates that the assay results are a reliable indicator of the metal concentrations of the mineralization. Gold assays correlate to mineralized veins and alteration zones.

The data presented for all ATAC's exploration meets NI 43-101 standards. It is the opinion of the Authors that the sample preparation, quality control, security and analytical procedures for work conducted on the Property by ATAC meet the standards as set out in National Instrument 43-101 and the results are representative of the mineralization of the Tiger Deposit.

12.0 DATA VERIFICATION

The following italicized portions of Section 12.0 of this report, **DATA VERIFICATION**, are taken verbatim from Stroshein (Protore Geological Services) et.al. from the previously published NI 43-101 Technical Report, dated November 15, 2011.

Samples from the diamond drilling programs were subjected to a Quality Control (QC) program designed by the Company. The QC program consisted of:

- *Sequentially numbered sample tickets: to identify each sample with a unique number to minimize the possibility of sample numbering errors and to ensure uniform collection of sample data.*
- *Sealed sample bags: to secure individual sample bags to reduce the possibility of sample contamination, spilling or tampering.*
- *Chain of custody: samples were stored in secure preparation area and delivered to the laboratory directly by company personnel or commercial freight carrier.*
- *Sample duplicates: selected samples were re-submitted for assay. There were normally three or four samples duplicated for each drill hole.*
- *Sample blanks: commercial samples were purchased and inserted in the sample sequence. All blank samples yielded background values, including samples inserted directly following a “standard” value to test for “smear effect” during the sampling process, indicating no observable contamination. Thus, the analytical techniques employed by ALS Chemex can be considered highly reliable. These blanks were assigned unique sample numbers within the sample sequence so as to be “blind” to the laboratory.*
- *Reference standard samples: Four different commercial standard samples for gold in sulphide and four commercial standard samples for gold in oxide that ranged from 0.41 to 8.66 g/t gold. The reference standards were assigned unique sample numbers within the sample sequence.*

The Authors have verified the data from the records between 2008 and 2010 carried out by ATAC. Verification of the data included:

- *Comparing assay certificate data to log assays sheets.*
- *Compared assay results to the lithological and mineralization descriptions in the log sheets.*
- *Compared assay results for the standard, blank and duplicate samples.*
- *Re-calculated composite assay averages and compared those reported by the Company.*

13.0 MINERAL PROCESSING AND METALLURGICAL TESTING

Seven separate surveys directly and indirectly associated with metallurgical testing have been completed on the potential sulfide and oxide ore comprising the Tiger Deposit mineralization. The following work was conducted over a six year period by independent contractors:

- Sulfide petrographic studies – Micron Geological Ltd. (BC) 2009/2010
- Sulfide Flotation/Cyanidation Surveys – G&T Metallurgical Services (BC) 2009/2010
- Gold deportment studies - Surface Science Western (ON) 2010
- Bio-oxidation studies – SGS Minerals Services (ON) 2010/2011
- Oxide cyanidation – ALS Group (BC) 2009
- Oxide cyanidation, preliminary heap leach investigations – SGS Minerals Services (ON) 2010-2012
- Oxide heap leach and hybrid process investigations – KCA (NV) 2013/2014

13.1 Sulfide Petrography

Micron Geological Ltd. (Peter LeCouter) performed gold characterization on samples from the Rau Property during fall and winter 2009/2010. This work was done on five grain mounts and six polished thin sections. Material for the construction of the grain mounts was selected from coarse reject drill core from the 2009 drilling within the sulfide facies of the Tiger Deposit and East Zone. Select grains were collected and sent to Vancouver Petrographics Ltd. in Burnaby, BC, where they were mounted in epoxy and polished.

The polished grain mounts were examined by transmitted/reflected light microscope and minerals of interest were analyzed on an AMRAY 1810 scanning electron microscope equipped with an EDAC “Genesis” energy dispersive X-ray analyzer.

Comments from Micron Geological Ltd’s report of findings are described below.

13.1.1 Grain Mounts

The samples appear to have relatively simple mineralogy consisting mainly of pyrite (40-70%) and arsenopyrite (0-45%) with 5% to 25% dolomite. Small amounts of fine-grained bismuthinite (many antimonial) are present in all samples including native bismuth.

Sulfide ore microscopy identified gold-bismuth alloys in two of the five samples. Gold content within the alloy ranges from 19% to 76%.

13.1.2 Polished Thin Sections

Six polished thin sections were prepared from core specimens collected from 2008 drill holes Rau-08-04, -05 and -11. The samples covered a range of gold grades from 0.6 to 8.3 g/t and also covered a variety of sulfide compositions. Native gold was observed in two samples and a gold-bismuth alloy was noted in another.

In some instances arsenopyrite occurs as composite grains with the pyrite but there appears to be no association with gold. One native gold grain measuring 50 microns occurs as a composite with bismuthinite and a very small grain of arsenopyrite all occurring within a larger pyrite grain.

The other occurrence of gold was from a pyrite dominant piece of mineralization from the Upper Horizon in DDH-08-11. Modal sulfide content for pyrite and arsenopyrite is 50% and 35%, respectively. The interval assay from which the specimen was collected was 8.13 g/t. Four irregular shaped grains of native gold were observed up to 75 microns long and 35 microns wide. All occur within larger pyrite grains and appear to be along grain boundaries.

13.2 Sulfide Flotation/Cyanidation Surveys

During winter 2009/2010, G&T Metallurgical Services Ltd. (“G&T”) was retained to perform scoping level metallurgical tests on five select composite sulfide samples from the Tiger Deposit and East Zone. Composite data for the samples is shown in Table 13-1 below.

**Table 13-1
Composite Data**

Zone	Hole #	Composite #	W.A. (g/t Au)	Average Sx (%)
Tiger	RAU-09-60	2	7.61	15
	RAU-09-67	3	4.60	10
	RAU-09-69	4	2.40	8
East	RAU-09-44	1	8.72	16
	RAU-09-61	5	4.58	30

All composites were subjected to Bulk Mineral Analyses (BMA) using the QEMSCAN technique. Key observations indicate the material composition for the Tiger Deposit and East Zone are mineralogically distinct with respect to carbonate and sulfide compositional ratios. Table 13-2 illustrates the respective carbonate and sulfide ratio data.

**Table 13-2
Bulk Mineral Analysis Data**

Zone	Hole	Comp #	Dolomite (%)	Ankerite (%)	Dol:Ank	Pyrite (%)	Aspy (%)	Py:Aspy
Tiger	09-60	2	23.0	26.0	0.88	31.4	10.4	3.0
	09-67	3	20.7	23.3	0.89	34.4	11.9	2.9
	09-69	4	34.3	19.2	1.79	24.9	5.9	4.2
East	09-44	1	38.2	9.5	4.01	31.3	Tr*	31.3
	09-61	5	15.4	4.9	3.16	70.8	2.5	28.8

* Trace

A series of whole ore cyanidation and flotation tests were conducted on all composites. Cyanidation parameters were as follows:

Primary Grind: 70 to 77 micron
 Secondary Grind: 15 to 20 micron
 Leach pH: 11
 NaCN conc: 2000 g/t
 Residence Time: 48 hrs
 Procedure: Bottle Roll Volume: 500 g

Table 13-3 shows the results of the first phase cyanidation tests.

**Table 13-3
Phase I Cyanidation Results**

Zone	Comp #	Au Distribution (%)	Au Distribution (%)	Au Recovery (%)	Au Recovery (%)
Hours		6	48	6	48
Grind		75 micron	75 micron	15 micron	15 micron
Tiger	2	62.0	65.2	63.5	68.9
	3	22.5	23.4	23.5	30.1
	4	38.9	42.4	37.1	45.9
East	1	88.2	95.2		
	5	24.5	35.2		

The East Zone material composite 09-44 responded very well to cyanidation at 75 micron grind yielding 95.2% recovery in 48 hours. The Tiger Deposit material responded less favorably yielding recoveries between 23% and 65%. In all cases the cyanide leach kinetic curves exhibit the highest percentage gold extraction within the first six hours with between 1% and 11% residual leach taking place in the remaining 42 hours.

The three composites from the Tiger Deposit were also taken to ultra-fine grind of 15 to 20 microns and subjected to the same cyanidation process. Percentage gold distribution for composites two through four increased by 6%, 29% and 8%, respectively when comparing final residence time of 48 hrs.

Open circuit rougher flotation tests were performed to evaluate the gold recovery in a rougher flotation concentrate. Approximately 2,000 grams of composite material for each sample was ground to a primary grind size of approximately 75 microns and processed through a standard one product rougher kinetic flotation system using a neutral pH of about 8.0 and potassium amyl xanthate to collect the sulfide minerals.

Results of the flotation tests showed the final rougher concentrate gold grades ranged between 62% and 137% higher than those of their respective feed materials. The small increase in gold concentrate grade indicates there is a large volume of sulfides comprising the final concentrates.

Gold recoveries from the flotation tests for Composite 1 (East Zone) are excellent, yielding 97%. Material from Composites 2-4 (Tiger Deposit) had gold recoveries between 82% and 87%, with a calculated 77% to 89% sulfide content. Table 13-4 lists the results of the cumulative metallurgical balances for these rougher flotation tests.

**Table 13-4
Cumulative Balances for Phase I Rougher Flotation Tests**

Zone	Comp #	Feed	Flotation Concentrate		Flotation Tails	
		Au (g/t)	Au (g/t)	Au Recovery (%)	Au (g/t)	Au Recovery (%)
East	1	7.82	17.4	97.1	0.41	2.9
Tiger	2	7.89	14.9	84.1	2.26	15.9
	3	4.65	7.53	82.3	1.67	17.7
	4	2.27	5.37	87.3	0.46	12.7

Because a significant proportion of gold appears to be contained within the Tiger Deposit flotation tails, additional cyanidation leach tests were performed on 500 grams of material from bulk flotation tails generated from a second phase of flotation tests required for bench scale pressure oxidation testing.

Leach efficiency of the tails was low, with recoveries not exceeding 31.7% of the gold contained within the tails. Table 13-5 shows the cumulative balances for the Phase II rougher concentrates and Table 13-6 shows the results for leach tests on the flotation tails.

**Table 13-5
Cumulative Balances for the Phase II Rougher Flotation Tests**

Comp #	Feed	Flotation Concentrate		Flotation Tails	
	Au (g/t)	Au (g/t)	Au Recovery (%)	Au (g/t)	Au Recovery (%)
2	7.44	13.8	91.3	1.28	8.7
3	4.29	6.78	78.7	1.82	21.3
4	2.04	5.16	90.0	0.32	10.0

**Table 13-6
Cyanidation Results for Phase II Flotation Tails**

Comp #	Feed Grade Au (g/t)	Au Recovery (%)	
		6 hours	48 hours
2	1.37	23.5	26.0
3	1.98	17.5	19.2
4	0.33	18.6	31.7

The maximum gold recovery from cyanidation of the rougher tails was calculated to be 4% of the original feed mass.

The Phase II rougher flotation concentrates were subjected to additional Pressure Oxidation (“POX”) and CIL tests, performed by SGS Mineral Services (“SGS”) in Lakefield, Ontario. The following specifications were established for these tests:

Pressure Oxidation Parameters

Feed Mass: 100 g
 Pulp Density: 7.5% solids (w/w)
 Temperature: 250 °C
 Oxygen Over Pressure: 100 psi
 Retention Time: 90 minutes

CIL Parameters

Pulp Density: 20% solids (w/w)
 Pulp PH: 10.5-11
 CN Concentration: 1.0 g/L
 Carbon Concentration: 10 g/L preattritioned GRC22
 Retention Time: 48 hours

Near complete oxidation of the sulfide mineralization was attained in the pressure oxidation tests. The average sulfide oxidation was 99.5% for all three samples. CIL leaching of the POX residues produced very high gold extractions of between 96.6% and 98.6% in 24 hours. Overall, gold extraction using a combination of flotation, pressure oxidation and cyanide leaching of the POX residues and flotation tailings produced good gold recoveries. The overall unoptimized gold recoveries for composites 2, 3 and 4 were 94%, 80% and 92%, respectively.

13.3 Sulfide Gold Department Studies

Surface Science Western was retained to perform additional work on material from the rougher concentrates prepared by G&T to further characterize the gold in sulfide samples using Dynamic Secondary Ion Mass Spectrometry (D-SIMS).

Table 13-7 lists the composite data provided to Surface Science Western from G&T.

Table 13-7
Cumulative Balances for the Surface Science Rougher Flotation Concentrates

Zone	Comp #	Reference #	Feed	Flotation Concentrate	
			Au (g/t)	Au (g/t)	Au Recovery (%)
Tiger	2	2537-06	7.89	14.9	84.1
	3	2537-07	4.65	7.5	82.3
	4	2537-08	2.27	5.4	87.3

13.3.1 Scope of the Study

- General mineralogy and optical microscopy scan for visible gold grains
- Quantitative analysis of gold in sulfide minerals by D-SIMS.

13.3.2 Methodology

General mineralogy and optical microscopy scan for visible gold grains:

This part of the study addresses the presence of free gold and the abundance and morphological types of the sulfide minerals in the sample. Each sample was assayed for gold, arsenic, sulfide sulfur and other major elements. The sulfide concentrate was subjected to gravity separation using a superpanner which separates minerals with different specific gravities: gold, sulfides and rock minerals. Polished sections prepared from different mineral fractions were studied by optical microscopy in order to identify gold grains and characterize the sulfide minerals present in the samples. The free gold grains found in the sample are characterized by size and association. Although not included in the initial scope of this study, the composition of free gold grains was established by the SEM/EDX technique.

Quantitative analysis of gold in sulfide minerals by D-SIMS:

The D-SIMS technique is a benchmark technique for analysis of sub-microscopic (invisible) gold in minerals. This type of gold is present as finely disseminated colloidal size gold particles (<0.5 μ m) or as a solid solution in the mineral matrix of sulfide minerals and it is not directly amenable to cyanidation.

The following summary of results is taken from the final report prepared by Surface Science Western.

13.3.3 Gold Deportment Balance

The established forms and carriers of gold in the analyzed flotation concentrate samples are presented on the gold deportment diagram in Figure 13-1.

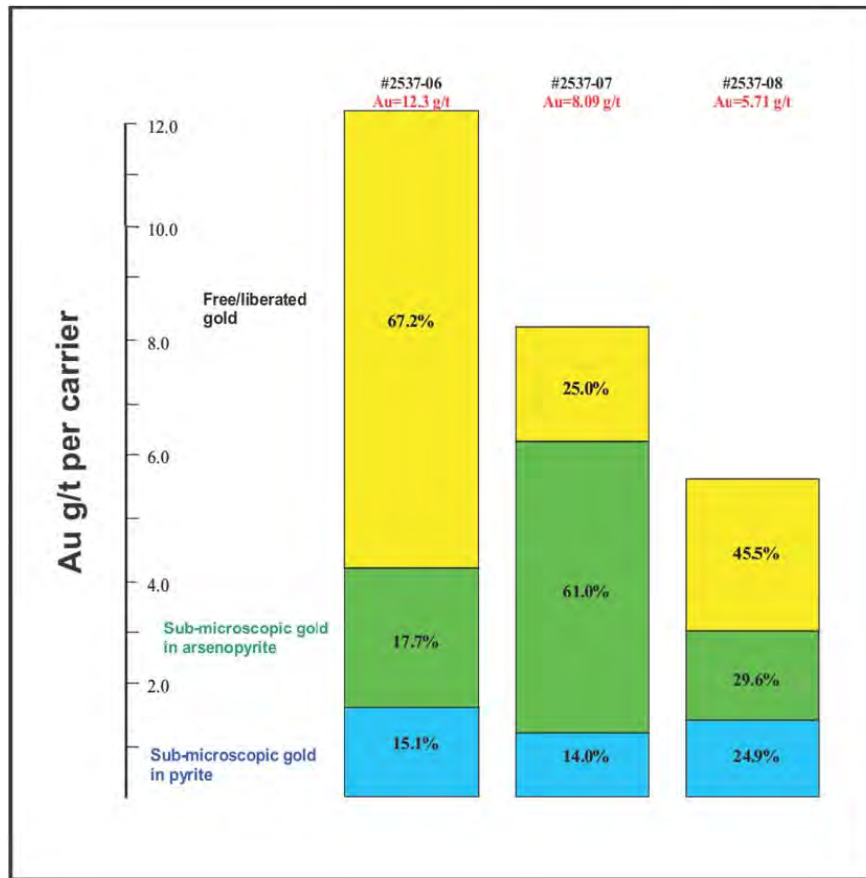

Figure 13-1

Gold Department Diagram with Relative Distribution of Gold per Carrier for Each Sample

13.3.4 Major Findings

Visible gold study

- Most of the gold grains are fully liberated or exposed (attached to other mineral phases). Based on the total surface area measured for exposed and locked gold grains, the fraction of encapsulated (locked) in other mineral phase visible gold is $\leq 1.8\%$.
- Size distribution: Most of the grains are in the 5-100 μm range.
- Composition: Both native gold and electrum were identified by the SEM/EDX compositional analysis.
- The ratio between the native gold and electrum grains for the observed grains is: 1:2.7.
- The average composition of the electrum grains is 96% gold and 4% silver.

- Some of the gold grains have an enclosed/attached separate pure bismuth phase.

Sub-microscopic gold study

The carriers of sub-microscopic gold among the analyzed mineral phases are ranked below:

- *Arsenopyrite: Major carrier. The estimated average gold concentration is in the range 10.8 ppm - 22.76 ppm. The occurrence of solid solution type sub-microscopic gold in the SIMS depth profiles for arsenopyrite was 73%, the rest being colloidal type of sub-microscopic gold.*
- *Pyrite: Secondary carrier. The average gold concentration in the various morphological phases of pyrite ranges from 1.34 ppm-3.97 ppm. All SIMS depth profiles in pyrite showed presence of colloidal type submicroscopic gold.*
- *There is a positive correlation between the measured sub-microscopic gold concentrations and the arsenic content in pyrite for all three samples (Figure 13-2).*

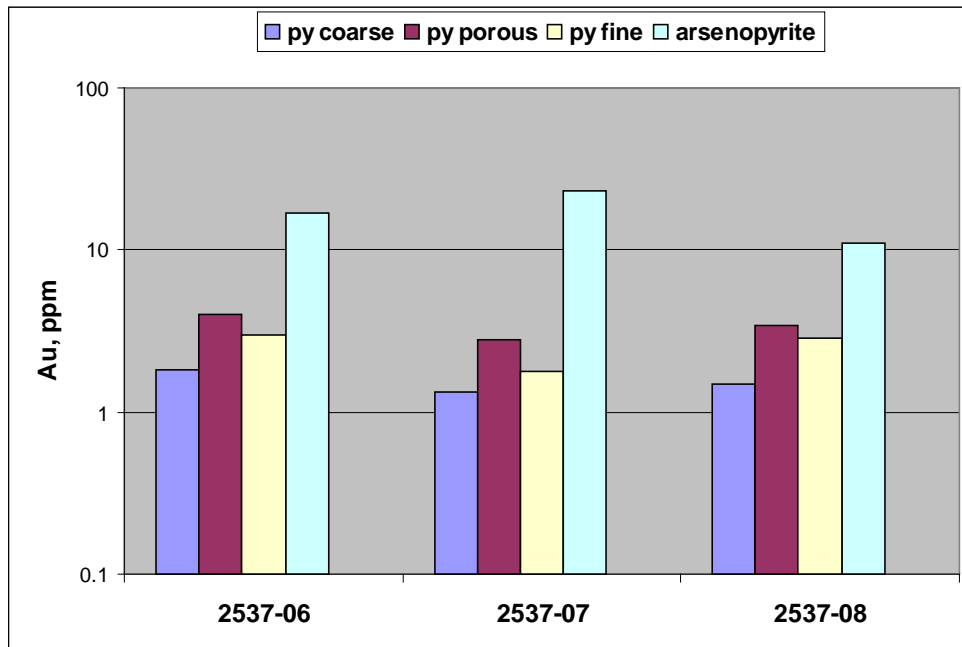

Figure 13-2
Relative Gold Distribution in Sulfides

13.4 Sulfide Bio-Oxidation Studies

During the winter of 2010/2011, SGS conducted a metallurgical test program on a Tiger Deposit sulfide composite sample for the purpose of determining the amenability of the sulfide mineralization to bio-oxidation (“BIOX”) and subsequent CIL cyanidation for the extraction of precious metals. The unit operations simulated in the metallurgical test program included milling, flotation, BIOX of the flotation concentrate, and CIL of the BIOX residue. In addition, neutralization of the BIOX liquor was undertaken. The resulting ferric arsenate from the neutralization was submitted for stability tests to determine its suitability for disposal in tailing ponds.

The material submitted for metallurgical testing comprised approximately 150 kg composited from 20 individual samples. The composite head graded 2.14 g/t gold, <0.5 g/t silver, and 2.5% arsenic, with 17% sulfides and 32% carbonates. The ore was subjected to rougher flotation for the recovery of gold and the flotation concentrate was subsequently submitted to ultra-fine grinding followed by cyanidation and BIOX/CIL.

The mass pull of the rougher flotation concentrate was high at 44% with a gold recovery of 97%. Gold extraction by cyanidation increased from less than 50% using the reground un-oxidized flotation concentrate, to over 91% in the BIOX residue. Sulfide oxidation increased from 75% after 10 days, to 98% after 30 days of BIOX retention time. However, the gold extraction by the CIL from the BIOX residue was essentially equal (between 91% and 93%) for all the BIOX residues of sulfide oxidation between 75% and 98%. The consumption of cyanide and lime during the CIL test were high, however their addition would need to be further optimized in a separate set of leach kinetic tests.

The Tiger Deposit BIOX liquor is amenable to neutralization by limestone and lime from pH 1.12 to pH 7 in a one stage process, consuming 0.12 kg of limestone and 0.016 kg of lime per liter of BIOX solution (equivalent of 1088 kg of limestone and 141 kg of lime per tonne of concentrate, for a BIOX pulp density of 9.9% solids). The concentrations of iron and arsenic in the filtrate from the neutralization are 0.08 mg/L and 0.02 mg/L respectively, which are below the limits of 0.5 mg/L and 1.0 mg/L respectively, set by the United States Environmental Protection Agency (“USEPA”).

The Toxicity Characteristic Leaching Procedure (“TCLP”) test on the residue from neutralization yielded extract containing 0.05 mg/L As, well below the 5 mg/L As limit set by the USEPA for waste disposal. The ferric arsenate precipitate can therefore be considered stable for disposal.

13.5 Oxide Metallurgy

Metallurgical studies were performed on oxide material from the Tiger Deposit in three campaigns, conducted by the ALS Group (“ALS”) in 2009, SGS from 2010-2012, and KCA from 2013-2014.

13.5.1 ALS 2009

The first of these studies was performed by ALS Group of North Vancouver, BC using coarse reject material from the mineralized interval in Rau-09-19 which assayed 24 g/t gold across 28 meters. The process utilized for these tests was the standard 24 hour bottle roll procedure which is a cyanide leach with Atomic Absorption Spectroscopy (“AAS”) finish.

In total, six 1 kg samples of varying grades from the Tiger Deposit drill hole Rau 09-19 were pulverized to 75 microns and subjected to cyanide leaching over a 24 hour cycle time. The process recovered an average 96.9% of the gold at all grade levels tested as illustrated in Table 13-8 below:

**Table 13-8
Preliminary Oxide Cyanide Leach Results**

Sample	Assay Head Au (g/t)	Calc. Head Au (g/t)	Au Recovery (%)
RAU-CY-A	85.70	82.60	96.38
RAU-CY-B	7.76	7.50	96.65
RAU-CY-C	4.69	4.51	96.16
RAU-CY-D	2.70	2.68	99.26
RAU-CY-E	0.83	0.77	92.77
RAU-CY-F	0.25	0.26	100.00
Average Recovery			96.9

13.5.2 SGS 2010-2012

During the 2010 exploration season one PQ hole (Rau-10-94) was drilled within the central portion of the Tiger Deposit oxide mineralization specifically for the purpose of metallurgical work. SGS was retained to perform scoping level gold recovery test work on a single composite made from 51 samples comprising the mineralized interval.

Samples were forwarded to SGS's Lakefield facility where a 1 kg portion of each of the 51 interval samples was riffle split from the - 10 mesh available sample material to form a composite sample. The 51 kg composite was combined, blended and further riffle split into 1 kg test charges.

13.5.2.1. Head Analysis

Duplicate ~1 kg charges of - 10 mesh material of the composite sample were submitted for Au analysis applying a screened metallics protocol at +/- 150 mesh. The screen undersize product was sampled (by riffling) and assayed in duplicate. Screen oversize material (metallics) was assayed to extinction. The head grade analysis of the composite yielded an average grade of 4.82 g/t gold.

13.5.2.2. Mineralized Material Characterization

A smaller head sample (~100 to 200 g) was submitted for sulfur speciation (S_T , S^0 , S^{2-} and SO_4) and carbon speciation (C_T , C_g , C_{org} , CO_2) analyses. An additional amount of - 10 mesh material was also submitted for a brief mineralogical evaluation as described in Table 13-9 below.

Table 13-9
Sulfide and Carbon Speciation

Element	Assay
S %	0.17
S^- %	<0.05
SO_4 %	0.30
S^0 %	<0.05
C_T %	2.91
C_g %	0.06
TOC Leco %	0.38
CO_3 %	13.00

The composite was also submitted for baseline environmental analysis including Acid Base Accounting (“ABA”) and Net Acid Generation (“NAG”) tests.

ABA results show a Neutralization Potential / Acid Generation Potential (“NP/AP”) ratio of 89.9.

A result of NAG = 0 at pH 4.5 and 7.0 generally implies the material will not generate acid, and will probably have neutralization potential.

Details of the environmental analysis work is shown below in Tables 13-10 and 13-11.

**Table 13-10
ABA Results**

Parameter		Head Master Comp.
Paste pH	units	7.98
Final pH	units	1.59
NP	TCaCO ₃ /1000 t	227
AP	14.0 TCaCO ₃ /1000 t	15.0 2.53
Net NP	16.0 TCaCO ₃ /1000 t	17.0 225
NP/AP	ratio	89.9
S	%	0.16
S ⁻	%	0.08
SO ₄ %	%	0.08
C _(T) %	%	3.01
CO ₃ %	18.0 %	19.0 13.4

**Table 13-11
NAG Results**

Parameter		Head Master Comp.
Sample	weight (g)	1.51
H ₂ O ₂	mL	150
Final pH	units	10.0
NaOH	Normality	0.1
NaOH to pH = 4.5	mL	0.0
NaOH to pH = 7.0	mL	0.0
NAG(kg H ₂ SO ₄ /tonne)	@ pH = 4.5	0.0
	@pH = 7.0	0.0

A multi-element analysis by semi-quantitative ICP was conducted on all samples. Results of several samples of mineralized material are presented in Table 13-12 below.

**Table 13-12
Multi Element Analysis**

Element	Unit	Sample					
		76081	76082	76083	76084	76085	76086
Ag	g/t	<6	<6	13	<6	<6	<6
Al	g/t	5,500	13,000	30,000	49,000	86,000	85,000
As	g/t	17,000	14,000	10,000	1,400	1,900	1,300
Ba	g/t	460	630	1,300	1,600	2,600	2,700
Be	g/t	<0.3	0.3	0.7	1	1.5	1.5
Bi	g/t	3,000	1,100	1,200	<20	32	<20
Ca	g/t	5,200	5,300	39,000	120,000	48,000	55,000
Cd	g/t	<50	<50	<50	<50	<50	<50
Co	g/t	27	30	23	32	34	45
Cr	g/t	8	14	50	27	41	60
Cu	g/t	16	26	330	13	18	25
Fe	%	46.8	47.2	26.1	10.2	10.1	8.52
K	g/t	100	1,900	11,000	22,000	39,000	36,000
Li	g/t	<30	<30	<30	<30	<30	<30
Mg	g/t	3,900	5,400	30,000	53,000	27,000	29,000
Mn	g/t	1,900	1,700	1,400	1,500	630	620
Mo	g/t	<5	<5	<5	<5	<5	<5
Na	g/t	69	130	280	490	850	870
Ni	g/t	<20	25	37	61	77	88
P	g/t	470	1,100	1,200	2,100	1,700	1,100
Pb	g/t	300	<200	<200	<200	<200	<200
Sb	g/t	35	<30	<30	<30	<30	<30
Se	g/t	<30	<30	<30	<30	<30	<30
Sn	g/t	<50	<50	<50	<50	<50	<50
Sr	g/t	9.9	15	28	32	25	27
Ti	g/t	340	5,100	7,100	13,000	23,000	24,000
Tl	g/t	<30	<30	<30	<30	<30	<30
U	g/t	<100	<100	<100	<100	<100	<100
V	g/t	11	42	63	110	170	180
Y	g/t	16	16	12	14	17	16
Zn	g/t	1,800	1,200	800	440	390	250

Gold distribution in the master composite was assayed separately for +150 mesh and -150 mesh splits as a mass percent within each size fraction. The analysis showed that 99% of the gold reports to the -150 mesh fine fraction, confirming the fine grained nature of the gold in this system.

A Bond Ball Mill Work Index (“BWI”) test was conducted on the master composite with a result of 8.5 kWh/t.

19.1.1.1. Mineralogical Evaluation

The composite was subjected to qualitative mineralogical evaluation using the QEMSCAN technique. The Rapid Mineral Scan evaluation package was applied. The evaluation shows the majority (~75%) of the sample is comprised of non-opaques, likely dolomite and quartz, while goethite and limonite comprise the main oxides. Goethite grains are largely liberated (85%) with 6% of the grains “attached” and 9% of the grains “locked”.

Other non-opaques of particular interest are traces of graphite and Total Carbonaceous Matter (“TCM”), which were found in minor quantities and do not appear to be problematic with respect to preg-robbing in the cyanidation processes.

19.1.1.2. Metallurgical Testing

Scoping level metallurgical testing evaluated the following process options in order to determine basic flow sheet configurations:

- Gravity recovery of gold,
- Flotation of gravity tailings and whole ore,
- Cyanidation of whole ore, gravity tailings and flotation concentrate.

19.1.1.3. Gravity Separation Test Work

This test work was conducted at a grind of P80 ~150 µm. Two tests were conducted, with each consisting of a 10 kg charge ground and processed through a Knelson MD-3 concentrator. The Knelson concentrates were recovered and upgraded further by treatment on a Mozley mineralseparator. The Mozley concentrates (5 – 10 g) were assayed to extinction for Au. In the first test, the Mozley and Knelson tailings were recombined, blended and divided into representative ~1 kg charges for downstream cyanidation test work. In the second test, the combined tailings were assayed directly in duplicate.

The gravity separation tests suggest up to 18% gold recovery may be possible, as shown in Table 13-13.

**Table 13-13
Gravity Separation Results**

Test	Feed Size P80 (µm)	Gravity Concentrate			Tailing Grade Au (g/t)	Head Grade Au (g/t)	
		%Mass	Au (g/t)	% Au Rec.		Calc.	Direct
G-1	158	0.064	302	4.9	3.75	3.94	4.82
G-2	177	0.077	1,080	18.0	3.81	4.64	

19.1.1.4. Cyanidation Tests

Standard bottle roll cyanidation tests were completed on samples of the master composite and of the gravity tailings generated from the test work described in 13.5.2.5. Tests were completed at four grind sizes ranging from 84 µm to 158 µm. Pulp densities were maintained at 40% and the leach time was 48 hrs, monitored at 8, 24 and 48 hour retention times.

Applying the same conditions as indicated above, CIL tests were completed on a master composite and a gravity tailing sample. Grind sizes for the CIL tests ranged from 69 µm to 76 µm.

Normalized gold extraction at maximum retention time ranged from 89.7% to 91.2%. It should be noted that 85 to 90% of the gold extraction was achieved in the first 6 hours of the cyanidation process.

The results of the gravity tailings cyanidation and the whole-ore bottle rolls are presented in Table 13-14 and Figure 13-3.

**Table 13-14
Cyanidation Results**

Feed	Test No.	Feed Size Micron	Reag. Consum. kg/t of CN Feed		Au Extraction (%)				Residue, Au (g/t) Avg.	Head, Au (g/t)
			NaCN	CaO	8h	24h	48h	O'all Grav + CN		Calc.
Whole Ore	CN-1	131	0.28	3.46	85	89	89.7	-	0.50	4.88
	CN-2	95	0.29	3.70	87	89	90.2	-	0.47	4.72
	CN-3	84	0.26	3.79	90	91	91.2	-	0.42	4.77
	CIL-8	69	0.28	4.09	-	-	90.9	-	0.45	4.93
Gravity Tailing (Test G1)	CN-4	158	0.33	3.58	83	85	86.6	87.3	0.53	3.92
	CN-5	108	0.25	3.70	86	88	88.0	88.6	0.47	3.91
	CN-6	86	0.24	3.90	88	89	88.4	89.0	0.44	3.80
	CIL-7	76	0.19	4.58	-	-	86.4	87.1	0.46	3.36

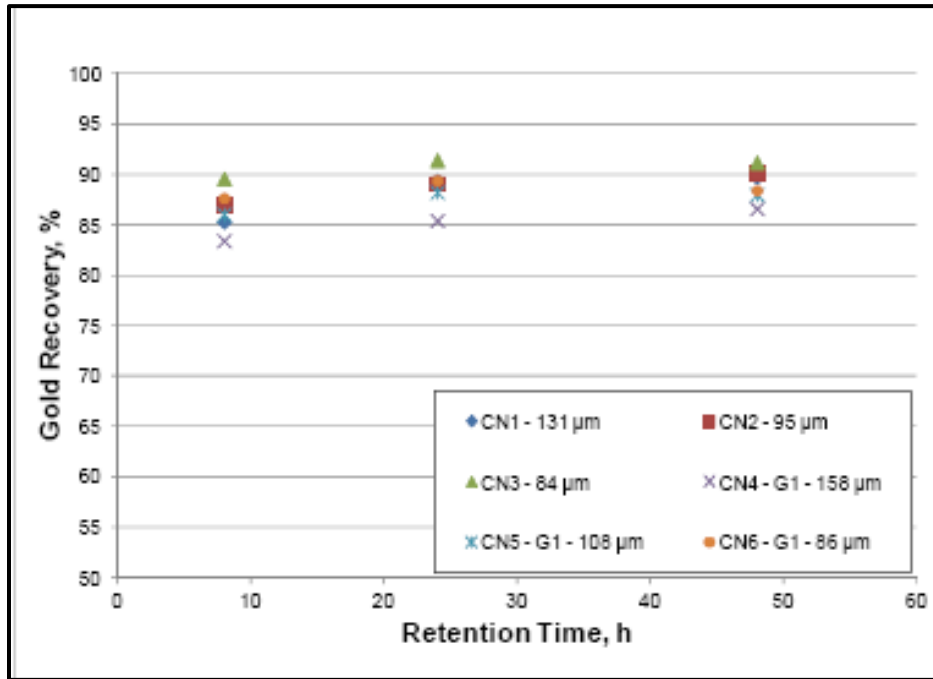

Figure 13-3
Bottle Roll Leach Kinetics

19.1.1.5. Coarse Bottle Roll Cyanidation Tests

Applying similar baseline conditions as indicated above, three coarse bottle roll cyanidation tests were conducted by SGS in 2012 at 1/4", 1/2", 3/4" and 1" crush sizes. Bottles were rolled one minute per hour of leaching time. The results are shown below in Figure 13-4.

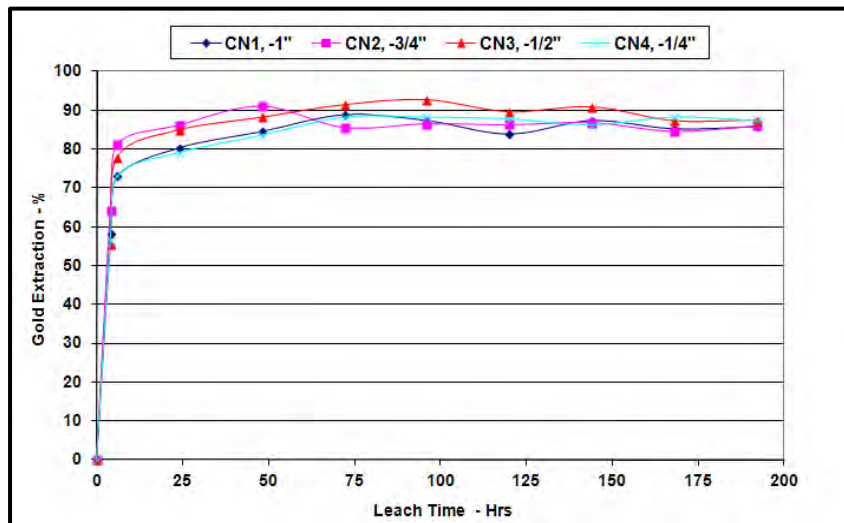

Figure 13-4

Coarse Ore Bottle Roll Leach Kinetics

19.1.1.6. Column Test

In addition to the coarse bottle rolls, a single column leach test was performed on the - 3/4" material. Before the column test was loaded, agglomeration tests were run to determine appropriate cement addition. Lime addition was kept constant at 3.42kg/t, and a solution flow-rate of 1.3 mL/min was used for all tests. Results are summarized below in Table 13-15.

Table 13-15
SGS Agglomeration Tests

	AG-MC-1-A	AG-MC-1-B	AG-MC-1-C	AG-MC-1-D
Cement	5 kg/t	10 kg/t	15 kg/t	0 kg/t
Initial Sample Height	28.5 cm	29.4 cm	28.5 cm	30.5 cm
Final Sample Height	23.5 cm	25.3 cm	27.3 cm	21.8 cm
Observations	No fines accumulating in the feed water	No fines accumulating in the feed water	No fines accumulating in the feed water	Fines accumulating in the feed water
	Slight change in sample height during test	Slight change in sample height during test	No change in sample height during test	Sample height changed to 26.0 cm from 30.5 cm
	Maintained agglomerated samples	Maintained agglomerated samples	Maintained agglomerated samples	Sample partially disagglomerated
	No percolation issues	No percolation issues	No percolation issues	No percolation issues
	Sample wet thoroughly	Sample wet thoroughly	Sample wet thoroughly	Sample wet thoroughly
	Easily squished (2)	Required a little bit of strength to break (2)	Requires a good amount of strength to break (5)	Integrity rating of (1)
Best Agglomerate	x	v	v	x

Based on the above results, an addition of 10 kg/t of cement was used for the column test. The results of the column test are presented in Table 13-16 and Figure 13-5.

Table 13-16
SGS Column Test

Sample	Test No.	Nominal Particle Size	Consumption (kg/t of CN Feed)		Gold Extraction (%)	Residue (g/t)	Calc Head (g/t)	Direct Assay *
			NaCN	CaO				
Master Comp	CL-1	-3/4 inch	0.15	2.62	88.9	0.49	4.44	4.33

* The average gold grade from the feed assays of four coarse ore bottle rolls was used as the direct assay.

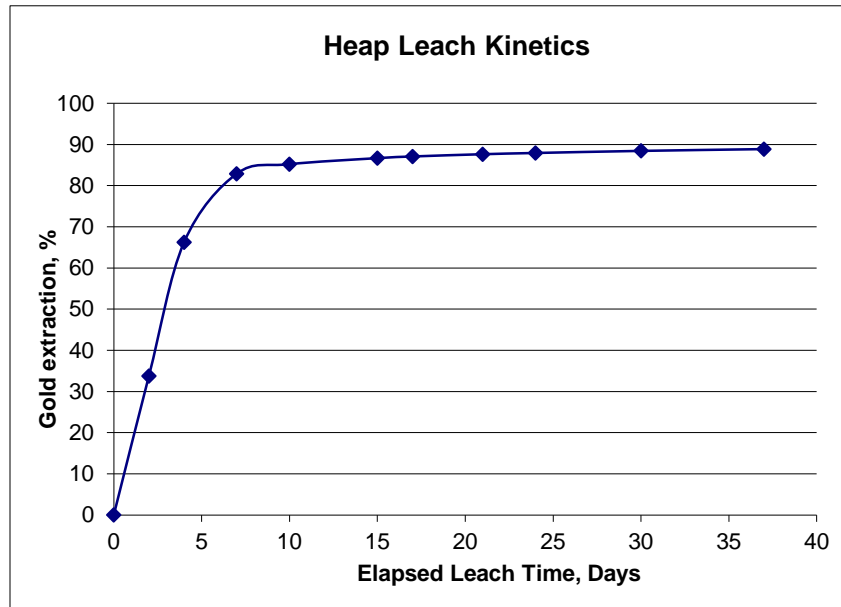

Figure 13-5
SGS Column Test Recovery Curve

19.1.2 KCA Programs 2013 / 2014

Auger drill samples from the Tiger Deposit were obtained during September / October 2013. Attempts to sample using a backhoe were also made, but the pits did not reach depths necessary to encounter representative oxide material, and samples from the pits were not treated.

The four auger holes (AO1, AO2, AO3, and AO4) were all 13 - 14 meters deep. Each hole was divided into an Upper and Lower portion and blended to make an upper and a lower composite. The boundary between Upper and Lower was chosen to be 8.5 meters. The Upper portions contain slightly more gravelly material and many of the sample intervals were very wet, upon receipt by KCA.

The location of the auger holes are shown below in Figure 13-6.

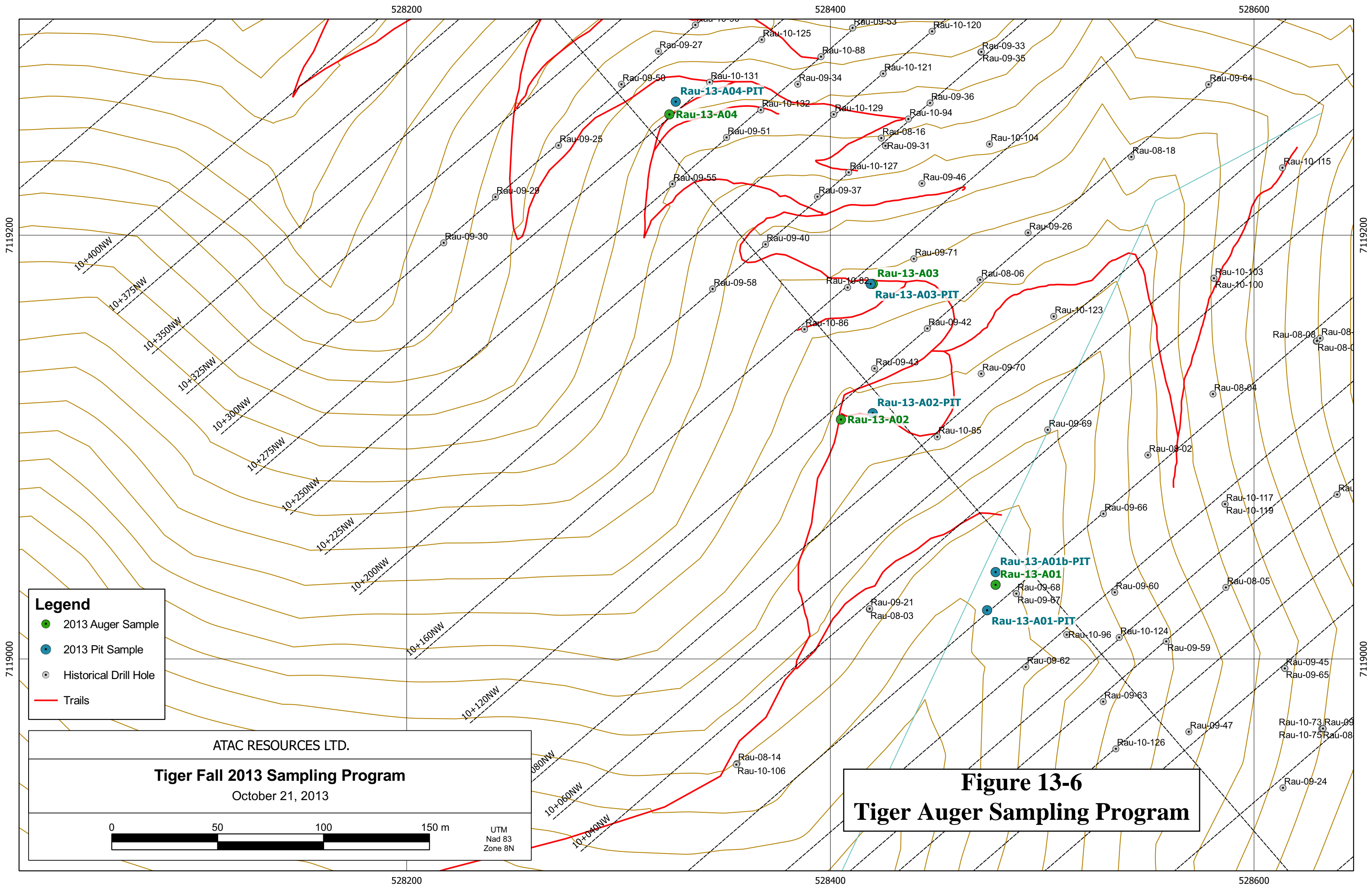

Legend

- 2013 Auger Sample
- 2013 Pit Sample
- Historical Drill Hole
- Trails

ATAC RESOURCES LTD.

Tiger Fall 2013 Sampling Program

October 21, 2013

UTM
Nad 83
Zone 8N

Figure 13-6
Tiger Auger Sampling Program

The material augered from the Tiger Deposit was soft and fine, indicative of the overall decomposed and oxidized nature of the mineralization.

Assay results by interval of each auger hole are shown in Table 13-17.

Table 13-17
Auger Hole Assays by Interval

KCA Sample No.	Auger Hole	Interval From (meters)	Interval To (meters)	Composite	Received Weight (kg)	Assay (Au g/t)	Assay (Ag g/t)
69969 A	RAU-13-A01	2.3	4.0	Upper	24.20	0.346	3.806
69969 B		4.0	5.5	Upper	23.54	0.336	1.989
69969 C		5.5	7.0	Upper	26.88	2.925	0.789
69969 D		7.0	8.5	Upper	26.78	2.287	2.400
69969 E		8.5	10.1	Lower	34.84	0.946	3.600
69969 F		10.1	11.6	Lower	32.24	1.971	2.811
69969 G		11.6	13.1	Lower	30.06	2.667	3.017
69969 H		13.1	14.6	Lower	20.02	3.909	2.811
69970 A	RAU-13-A02	2.4	4.3	Upper	19.62	0.134	4.217
69970 B		4.3	5.5	Upper	21.24	52.629	6.000
69970 C		5.5	7.0	Upper	22.14	4.697	5.211
69970 D		7.0	8.5	Upper	25.12	1.042	1.509
69970 E		8.5	10.1	Lower	27.24	2.249	0.994
69970 F		10.1	11.6	Lower	16.74	3.422	2.194
69970 G		11.6	13.1	Lower	18.98	0.996	2.400
69970 H		13.1	14.6	Lower	19.04	7.903	1.611
69971 A	RAU-13-A03	3.0	5.5	Upper	19.56	6.634	1.200
69971 B		5.5	7.0	Upper	21.86	11.143	0.789
69971 C		7.0	8.5	Upper	19.56	13.937	2.400
69971 D		8.5	10.1	Lower	18.86	5.760	1.989
69971 E		10.1	11.6	Lower	22.78	6.463	2.811
69971 F		11.6	13.1	Lower	15.90	3.531	2.606
69971 G		13.1	14.6	Lower	8.92	2.757	1.611
69972 A	RAU-13-A04	0.9	4.0	Upper	25.16	0.994	4.011
69972 B		4.0	5.5	Upper	14.28	4.303	5.589
69972 C		5.5	7.0	Upper	29.34	3.669	6.994
69972 D		7.0	8.5	Upper	29.48	4.980	6.206
69972 E		8.5	10.1	Lower	29.18	4.937	2.811
69972 F		10.1	11.6	Lower	28.50	4.046	5.006
69972 G		11.6	13.1	Lower	25.22	2.513	2.400
69972 H		13.1	14.6	Lower	24.42	3.823	4.217

The two master composites (Upper and Lower) were screened and assayed by size fraction. The weighted average head assay for each composite is presented in Table 13-18.

Table 13-18
Auger Composite Head Screen Analyses

KCA Sample No.	Description	Calc. p80 Size (mm)	Weighted Avg. Head Assay (Au g/t)	Weighted Avg. Head Assay (Ag g/t)
70037	RAU-13, Upper Composite	4.6	3.78	4.06
70038	RAU-13, Lower Composite	0.83	3.60	3.24

The overall particle size distribution of the Upper and Lower composites are presented below in Figure 13-7.

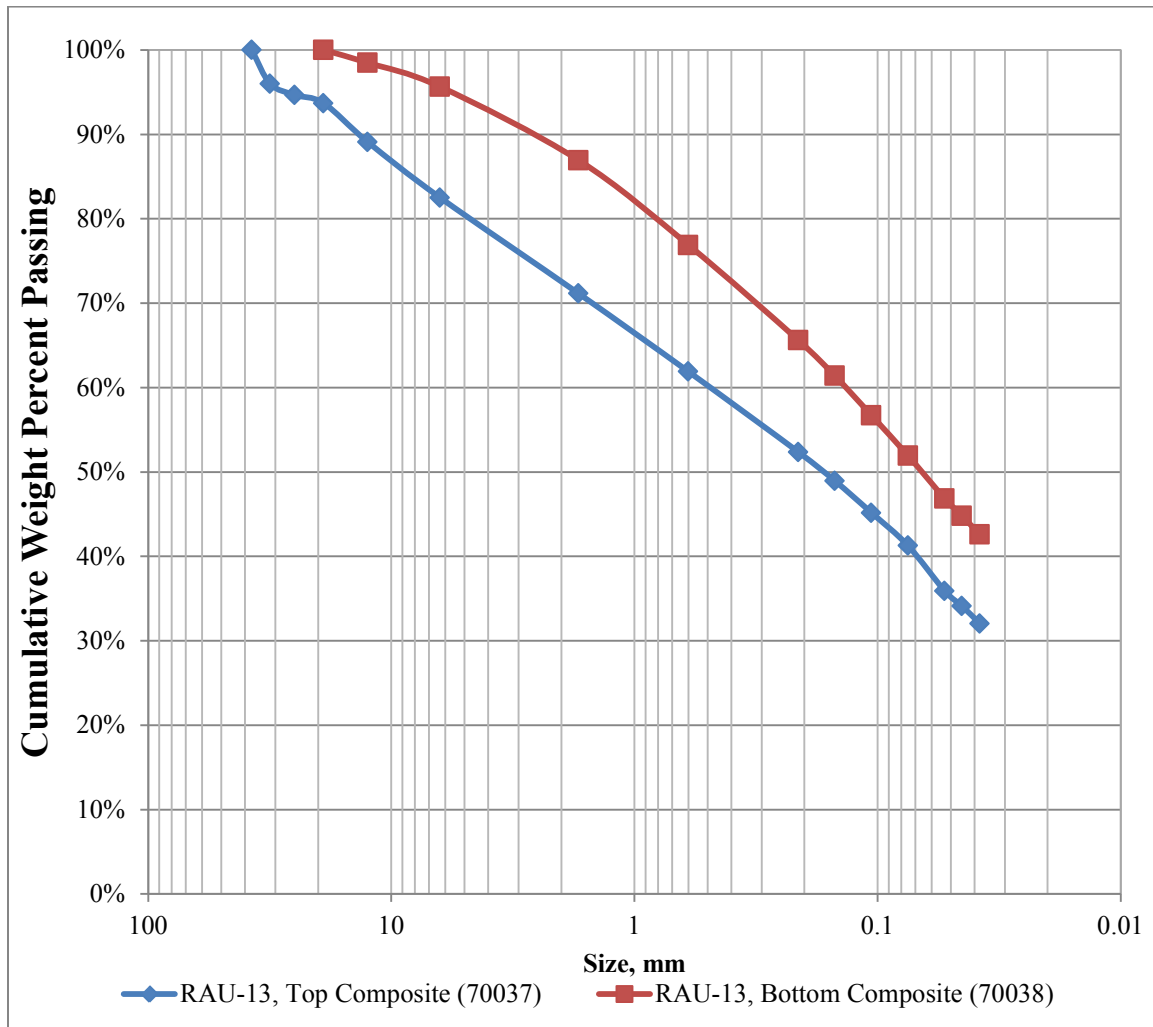

Figure 13-7
Size Distribution Auger Hole Composites

19.1.2.1. Conventional Heap Leach Test Work

This metallurgical program first evaluated conventional heap leaching through the use of column tests. Column tests were performed with 0.005 m² columns using 100% passing 12.5 mm material. Although high gold recoveries were obtained, it was determined that prohibitive amounts of cement were required for agglomeration, with challenges regarding stacking height and compacted permeability.

Agglomeration test results are shown in Table 13-19 below.

**Table 13-19
KCA Agglomeration Test Results**

KCA Sample No.	KCA Test No.	Composite	As-rec'd Wet Weight (kg)	Pre-Perc Moisture Content (%)	Cement (kg/t _{dry ore})	Water Added (mL)	Post-Perc Wet Weight (kg)	Post-Perc Dry Weight (kg)	Post-Perc Moisture Content (%)	Initial Height (cm)	Final Height (cm)	pH on Day 3	pH Comment	% Slump	Slump Result	Apparent Bulk Density (t _{dry} /m ³)	Flow Out (L/h/m ²)	Flow Result	Visual Estimate of % Pellet Breakdown	Pellet Result	Out Flow Solution, Color and Clarity	Solution Result ¹	Overall Test Result
70037	70057A	Upper	2.35	14%	2.0	45.0	2.40	2.02	16%	27.94	27.94	8.3	Low	0%	Pass	1.59	7,923	Pass	5%	Pass	Brown and Cloudy	Fail	Pass
70037	70057 B	Upper	2.35	14%	4.9	51.0	2.40	2.02	16%	27.31	27.31	9.9	Good	0%	Pass	1.62	14,018	Pass	3%	Pass	Brown and Cloudy	Fail	Pass
70037	70057 C	Upper	2.35	14%	9.9	58.0	2.41	2.02	16%	27.94	27.94	11.0	Good	0%	Pass	1.59	25,510	Pass	3%	Pass	Brown and Cloudy	Fail	Pass
70038	70057 D	Lower	2.44	17%	2.0	42.5	2.48	2.02	19%	26.99	26.99	7.8	Low	0%	Pass	1.64	3,705	Pass	5%	Pass	Brown and Cloudy	Fail	Pass
70038	70057 E	Lower	2.44	17%	4.9	42.0	2.48	2.02	19%	27.62	27.62	9.3	Good	0%	Pass	1.61	13,522	Pass	3%	Pass	Brown and Cloudy	Fail	Pass
70038	70057 F	Lower	2.44	17%	9.9	50.0	2.49	2.02	19%	27.94	27.94	10.3	Good	0%	Pass	1.59	14,229	Pass	3%	Pass	Brown and Cloudy	Fail	Pass

Note (1): Solution color and clarity is a qualitative tertiary test. Failure of solution color and clarity does not equate a failure of the perc test.

Following the agglomeration tests, columns were run under simulation of 8m of stack-height load. During these tests the columns gradually sealed off and were not percolating well. It was concluded that the cement required to agglomerate to a degree sufficient for adequate percolation would likely be prohibitive. Although the columns leached for up to 16 days and resulted in high recoveries, KCA does not recommend heap leaching materials under conditions where the material is clearly showing signs of sealing-off in lab tests.

Results are shown below in Table 13-20.

Table 13-20
Cyanide Column Leach Test Work
Summary of Metal Extractions and Chemical Consumptions

KCA Sample No.	KCA Test No.	Description	Crush Size, mm	Calculated Head, gms Au/MT	Extracted, % Au	Days of Leach	Consumption NaCN, kg/MT	Addition Cement, kg/MT
70037	70207	RAU-13, Top Composite	As rec'd	3.759	89%	14	2.85	2.00
70038	70213	RAU-13, Bottom Composite	As rec'd	3.633	89%	10	2.55	2.00
70037	70275	RAU-13, Top Composite	As rec'd	4.462	88%	16	1.43	16.00
70037	70276	RAU-13, Top Composite	As rec'd	3.704	86%	16	1.28	20.00

Note: Columns tested under compressive loads

KCA Sample No.	KCA Test No.	Description	Crush Size, mm	Calculated Head, gms Ag/MT	Extracted, % Ag	Days of Leach	Consumption NaCN, kg/MT	Addition Cement, kg/MT
70037	70207	RAU-13, Top Composite	As rec'd	3.92	21%	14	2.85	2.00
70038	70213	RAU-13, Bottom Composite	As rec'd	3.61	12%	10	2.55	2.00
70037	70275	RAU-13, Top Composite	As rec'd	3.86	21%	16	1.43	16.00
70037	70276	RAU-13, Top Composite	As rec'd	3.57	17%	16	1.28	20.00

Note: Columns tested under compressive loads

As part of the column test program, pregnant solutions were treated with activated carbon and the carbon assayed for mercury. The mercury loadings were very low, and results are shown in Table 13-21.

Table 13-21
Conventional Column Tests, Mercury on Carbon

KCA Sample No.	KCA Test No.	Composite	Carbon Period	Carbon Weight (g)	Carbon Assay (Au g/t)	Carbon Assay (Hg g/t)	Extracted to Carbon (Hg mg/kg)	Ratio Au:Hg
70037	70207	Upper	C-1	161.29	79.26	0.11	0.00	721
			C-2	167.83	3.60	0.03	0.00	144
			Total Extracted					
70038	70213	Lower	C-1	234.37	54.99	0.61	0.04	90
70037	70275	Upper	C-1	228.45	68.72	0.09	0.01	764
70037	70275	Upper	C-1	227.34	55.79	0.11	0.01	507

Pregnant solutions from the column tests were also tested specifically for copper. As shown in Table 13-22, copper concentrations are low, and treatment problems due to excessive copper in solution would not be expected.

Table 13-22
Conventional Column Tests, Copper in Solution

KCA Sample No.	KCA Test No.	Composite	Low Copper (mg/L)	High Copper (mg/L)
70037	70207	Upper	0.27	0.35
70038	70213	Lower	0.21	0.23
70037	70275	Upper	0.47	1.26
70037	70276	Upper	0.41	0.96

19.1.2.2. Hybrid Heap/CIL Test Work

Due to the poor agglomeration results, it was concluded that conventional heap leaching would not be appropriate for the Tiger Deposit oxide material. Subsequent testing focused on development of a hybrid CIL / heap leach flow sheet. A large split of the Lower composite was scrubbed in a cement mixer and screened at 0.212 mm. The clean oversize material was column tested and the undersize treated using a conventional bottle roll leach test. The results of the column test on oversize material are presented in Table 13-23 and Figure 13-8 below.

**Table 13-23
Scrubbed Oversize Column Test Results**

KCA Test No.	Composite	Crush Size (mm)	Calculated Head Grade (g/t)		Extracted Metal (g/t)		Tailings Grade (g/t)		Recovery (%)		Leach Time (days)	NaCN Consumption (kg/t)	Ca(OH) ₂ Addition (kg/t)
			Au	Ag	Au	Ag	Au	Ag	Au	Ag			
70349	Bottom	+0.212	4.729	1.60	4.277	0.30	0.452	1.30	90%	19%	22	4.91	2.00

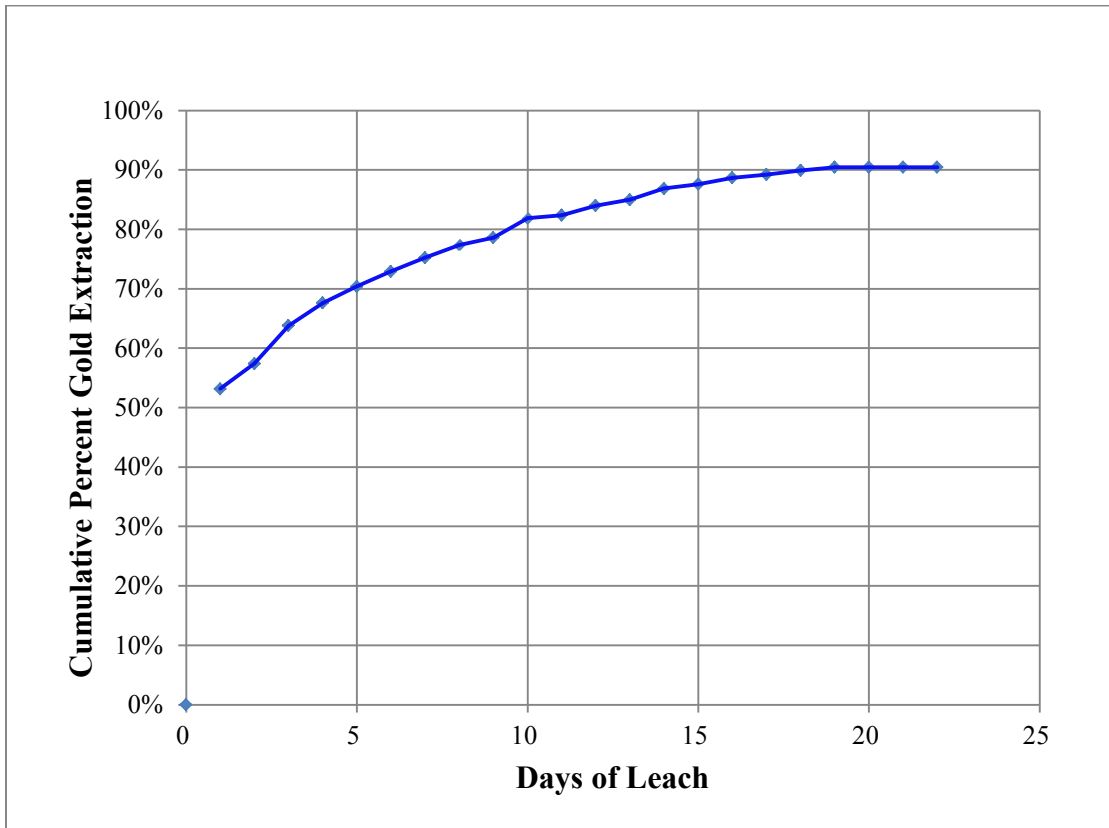

**Figure 13-8
Scrubbed Oversize Column Test Recovery Graph**

For the scrubbed oversize column test the bulk density was 1.947 t/m³ and retained moisture after drain-down was 11.07 L/ tonne dry ore.

A single column test was run on the Lower composite oversize, with a corresponding bottle roll test on the undersize material. However, due to sample quantity limitations, a column test could not be conducted on the Upper composite oversize, and as a result only bottle roll tests were conducted on both the oversize and undersize fractions of this composite. The results of the bottle roll tests for the Lower composite undersize, and the Upper composite oversize and undersize are presented in Table 13-24.

**Table 13-24
Scrubbed Materials Bottle Roll Test Results**

KCA Test No.	Composite	Fraction Size (mm)	Calculated Head Grade (g/t)		Extracted Metal (g/t)		Tailings Grade (g/t)		Recovery (%)		Leach Time (hrs)	NaCN Consumption (kg/t)	Ca(OH) ₂ Addition (kg/t)
			Au	Ag	Au	Ag	Au	Ag	Au	Ag			
70354A	Upper	+0.212	3.037	2.77	2.433	0.87	0.604	1.90	80%	31%	144	0.13	3.02
70355A	Upper	-0.212	4.643	3.15	4.288	0.65	0.355	2.50	92%	21%	96	0.49	6.00
70354B	Lower	+0.212	3.950	1.59	3.357	0.39	0.593	1.20	85%	25%	144	0.40	4.49
70355B	Lower	-0.212	3.245	1.92	3.043	0.41	0.202	1.51	94%	21%	96	0.70	6.00
70355C	Lower	-0.212	3.032	1.81	2.824	0.41	0.207	1.41	93%	22%	96	0.82	6.00

For the undersize material, the leach tests indicate that a retention time of 24 hrs should be sufficient to achieve adequate recovery, as presented in Figures 13-9 and 13-10 for gold and silver, respectively.

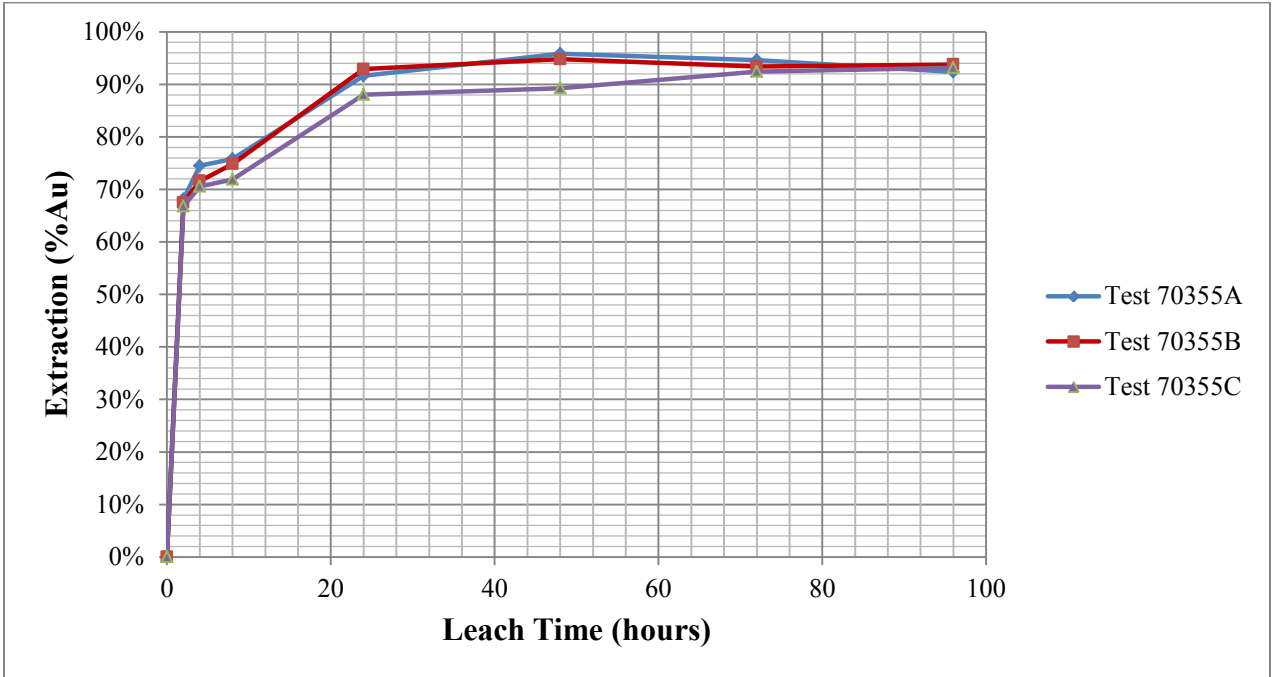

Figure 13-9
Gold Extraction vs. Time, Undersize Fraction

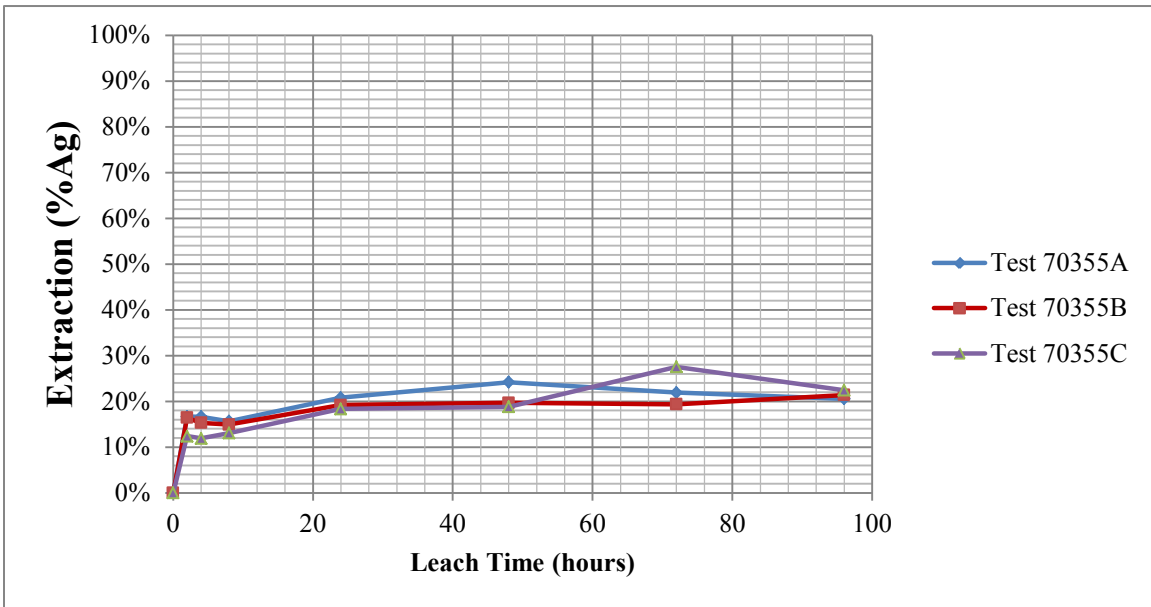

Figure 13-10
Silver Extraction vs. Time, Undersize Fraction

19.1.2.3. Conclusions of Metallurgical Studies

Based on KCA's metallurgical testwork, the following conclusions have been made:

- Conventional heap leaching of the Tiger oxide material is not viable due to high cement requirements necessary to obtain stable agglomerants.
- A hybrid heap / CIL approach was tested and appears to be a viable alternative process.
- The size split between the CIL and heap leach is 0.212 mm with the oversize material being delivered to the heap leach and the undersize material being delivered to the CIL circuit. Approximately 42% of the material is oversize.
- The heap leach cycle time is 50 days, with an estimated gold recovery of 87.8% and a silver recovery of 19.0%.
- The retention time for the CIL circuit is 24 hrs with an estimated gold recovery of 91.0% and a silver recovery of 19.0%.
- Combined recoveries for the hybrid heap leach / CIL plant are estimated to be 89.8% for gold, and 19.0% for silver.
- Material from the Upper and Lower portions of the deposit have similar metallurgical performance.

14.0 MINERAL RESOURCE ESTIMATE

14.1 Introduction

Giroux Consultants Ltd. was contracted to complete resource estimates on the Tiger Deposit, Rau Property Yukon. The resources were estimated by Gary Giroux, P.Eng., MASc. who is a qualified person and independent of the both the issuer and the title holder, based on the tests outlined in National Instrument 43-101. This resource was previously published as the NI-43-101 Tiger Mineral Resource Estimate, dated November 15, 2011.

14.2 Data Analysis

The data base consisted of 133 diamond drill holes totaling 25,562 m (see Figure 9-1). A total of 5,881 assays were provided. Gaps in the from-to record totaled 402 and represented missing or unsampled intervals in waste areas and no recovery in mineralized zones. Values of 0.001 g/t were inserted for missing or unsampled intersections. Gaps where there was no material recovered, within mineralized sections, were left blank.

The following lithologies were logged:

LST	Grey, fine to medium grained, bedded, variably fossiliferous limestone with intermittent zones of solution collapse structures. Major alteration types in the limestone are marbleization and dolomitization
DOL	White to yellow, coarse grained hydrothermal crystalline dolomite and ankerite.
DOL,MX	The “Tiger Zone”; white to yellow, coarse grained hydrothermal dolomite and ankerite with masses and bands of coarse, euhedral pyrite, arsenopyrite and variable pyrrhotite mineralization.
OX	Brick red to brown, clay-like to competent, fine to coarse grained, intensely oxide altered “Tiger Zone” with variable siderite and limonite alteration.
VOL	Green to brown, fine to medium grained, variably amygdaloidal and magnetic volcanics and volcaniclastics. Strong sericite and chlorite alteration overprints primary textures which at times exhibit ash/pumice textures.
LEP	Grey to brown, fine to medium grained, mottled, calcified pumice tuff volcaniclastics
MBL	White to light grey, sucrosic marble.
MX - SX	Massive to semi-massive sulfide mineralization
OVB	Overburden, glacial till and poorly developed soils
QV	White to translucent grey, coarse grained quartz vein with variable calcite and iron sulfide content.
ARG SHL	Argillites and shales
FLT	Fault zones

Assays were tagged with a lithology code and the statistics are tabulated below. The results show significant gold mineralization (Maximum Value) in eight out of the 11 lithologic units.

Table 14-1
Assay Statistics Sorted by Lithology

Lithology	Number Of Assays	Mean Au (G/T)	Standard Deviation	Minimum Value	Maximum Value	Coefficient Of Variation
OX	1,515	2.93	10.628	0.001	175.00	3.62
MX – SX	869	1.27	2.330	0.001	19.35	1.83
DOL	477	0.36	0.939	0.001	9.11	2.59
LEP	221	0.04	0.134	0.001	1.37	3.49
LST	2,188	0.13	0.619	0.001	21.00	4.95
MBL	214	0.11	0.378	0.001	4.19	3.54
VOL	695	0.12	1.276	0.001	31.90	10.36
QZ VN	38	0.16	0.250	0.005	1.21	1.61
FLT	9	0.05	0.044	0.005	0.14	0.81
ARG-SHL	14	0.11	0.156	0.001	0.51	1.37
OVB	40	0.01	0.020	0.001	0.10	3.11

As a result, the lithology alone was not the best method to constrain mineralization. ATAC's exploration consultants built a geologic 3D solid model to constrain the oxide zones and the sulfide zones in dolomite between a series of confining fault surfaces. The solids are shown below in Figure 14-1. Drill holes were "passed through" these solids, with the point each hole entered and left each solid, recorded. Assay values were then back tagged with a solid designation and the assay statistics tabulated in Table 14-2. Three oxide solids were modelled and the remaining lithologies were lumped into a main footwall solid and a smaller hanging wall solid sitting above the main mineralization. Thus the assays were subdivided into oxides and sulfide bearing lithologies.

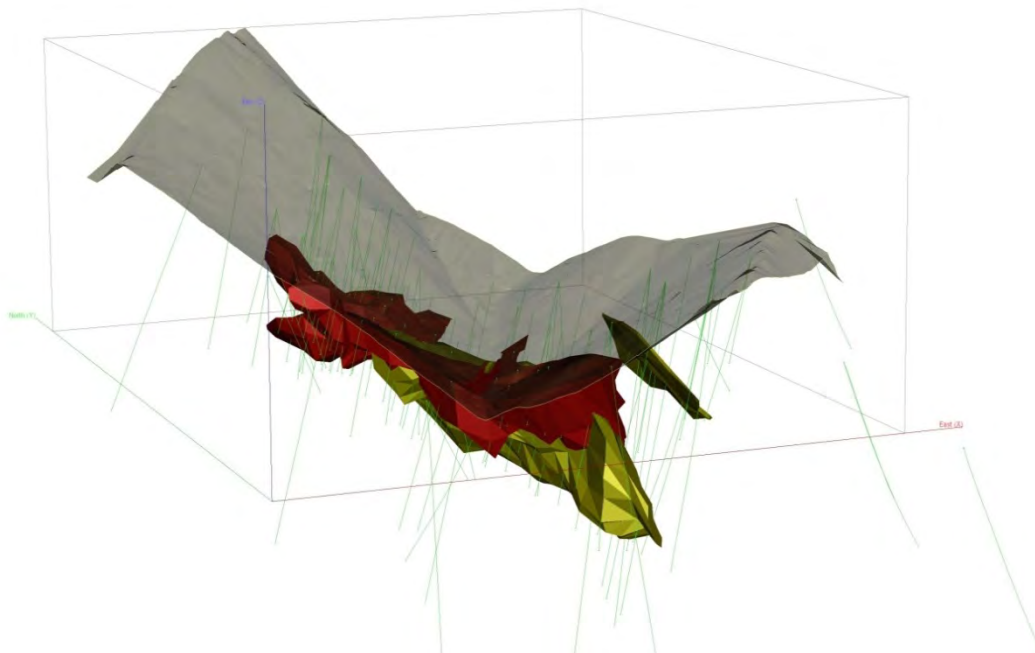

Figure 14-1
Isometric View Looking NE of the Oxide Solids in Red, Sulfide Solids in Yellow,
Surface Topography in Grey and Drill Hole Traces

Table 14-2
Assay Statistics from Solids

Number of Assays	Oxides		Sulfides	
	Au (g/t)	Ag (g/t)	Au (g/t)	Ag (g/t)
Mean Value	2.89	12.12	1.14	0.75
Standard Deviation	10.51	168.68	2.10	2.10
Minimum Value	0.001	0.001	0.001	0.001
Maximum Value	175.00	6280.00	19.35	30.10
Coefficient of Variation	3.63	13.92	1.85	2.80

The gold distributions, within the mineralized solids, were examined using a lognormal cumulative frequency plot to determine if capping was required and if so at what level. The procedure used is explained in a paper by Dr. A.J. Sinclair titled Applications of probability graphs in mineral exploration (Sinclair, 1976). In short the cumulative distribution of a single normal distribution will plot as a straight line on probability paper while a single lognormal distribution will plot as a straight line on lognormal probability paper. Overlapping populations will plot as curves separated by inflection points. Sinclair proposed a method of separating out these overlapping populations using a technique called partitioning. In 1993 a computer program called P-RES was made available to partition probability plots interactively on a computer (Bentzen and Sinclair, 1993). A screen dump from this program is shown for Oxide gold in Figures 14-2. On

this plot the actual gold distribution is shown as black dots. The inflection points that separate the populations are shown as vertical lines and each population is shown by the straight lines of open circles. The interpretation is tested by recombining the data in the proportions selected and this test is shown as triangles compared to the original distribution. In each case the grade distributions for gold and silver were positively skewed with multiple overlapping lognormal populations present.

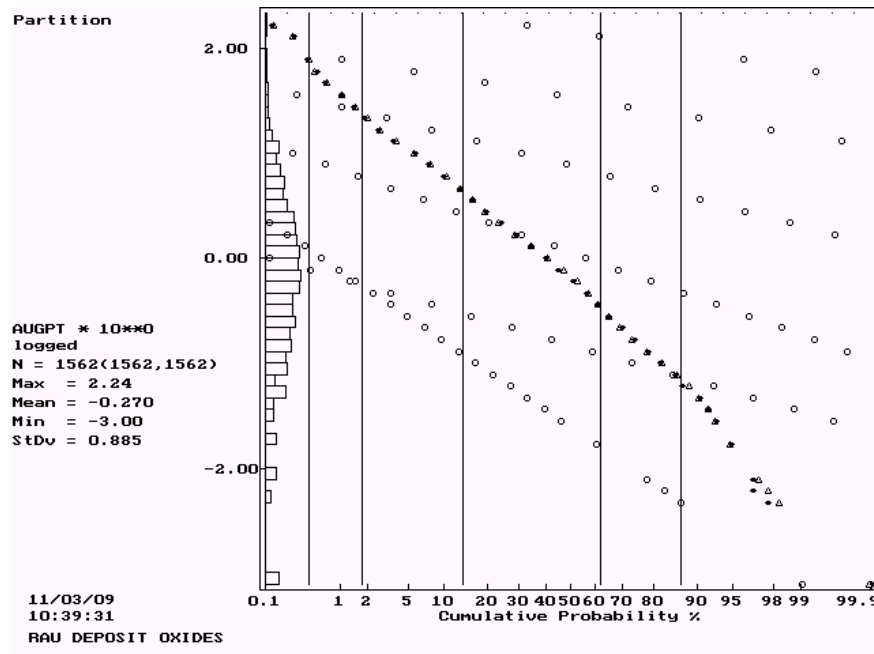

Figure 14-2
Lognormal Cumulative Probability Plot for Gold in Oxides

In the case of gold in oxides a total of six overlapping populations were identified as tabulated below.

Table 14-3
Gold Populations in Oxide Domain

Population	Mean Au (g/t)	Percentage of Total	Number of Assays
1	142.20	0.40 %	6
2	34.13	1.34 %	21
3	7.58	12.05 %	188
4	1.15	48.14 %	752
5	0.15	24.89 %	389
6	0.03	13.19 %	206

Population 1, with a mean grade of 142 g/t Au and representing 0.04% of the data can be considered erratic outlier mineralization. The samples in this population are scattered through the zone and don't represent a cohesive zone. A cap level of two standard

deviations above the mean of population 2 was chosen to cap population 1 assays. A total of 7 gold assays in oxides were capped at 69 g/t.

A similar exercise was completed for silver in oxides where the top 2 populations; 1 averaging 2,936 g/t Ag and representing 0.14 % of the data and 2 averaging 803 g/t Ag and representing 0.16 % of the data, were capped at two standard deviations above the mean of population 3. A total of 4 assays were capped at 418 g/t Ag.

For gold in sulfides the top population averaging 15.88 g/t Au and representing 0.63% of the data was considered erratic and capped at two standard deviations above the mean of population 2. A total of eight samples were capped at 11 g/t Au.

For silver in sulfides the top population averaged 25.3 g/t Ag and represented 0.30 % of the data. Three silver assays were capped at 17.0 g/t. The results of capping are tabulated below.

Table 14-4
Capped Assay Statistics from Solids

Number of Assays	Oxides		Sulfides	
	Au (g/t)	Ag (g/t)	Au (g/t)	Ag (g/t)
Mean Value	2.61	6.93	1.11	0.72
Standard Deviation	6.83	28.79	1.93	1.81
Minimum Value	0.001	0.001	0.001	0.001
Maximum Value	69.00	418.00	11.00	17.00
Coefficient of Variation	2.62	4.15	1.74	2.51

14.3 Composites

With 98% of assays less than or equal to 3.05 m in length (see Figure 14-3), a three meter composite interval was chosen. Composites were formed within each mineralized solid honoring the solid boundaries. Intervals at the boundaries less than 1.5 meters in length were combined with adjoining samples to produce composites of equal support 3 ± 1.5 meters in length. The statistics for composites in the oxide and sulfide solids are tabulated below.

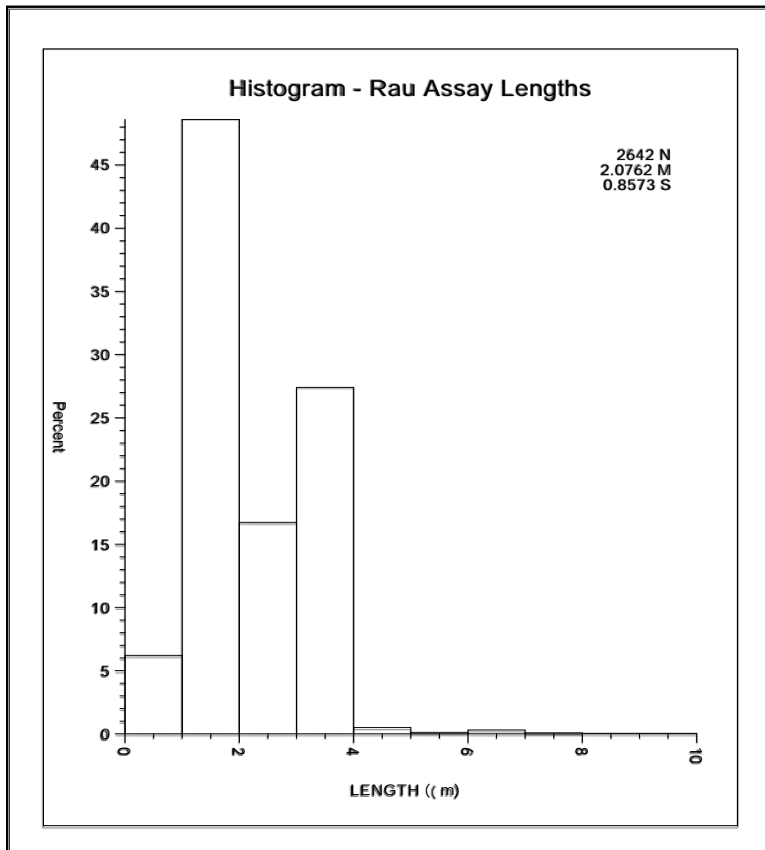

Figure 14-3
Histogram of Assay Sample Lengths

Table 14-5
3 m Composite Statistics from Solids

	Oxides		Sulfides	
	Au (g/t)	Ag (g/t)	Au (g/t)	Ag (g/t)
Number of Assays	985	985	826	826
Mean Value	2.55	6.03	1.04	0.63
Standard Deviation	5.63	18.80	1.57	1.38
Minimum Value	0.001	0.001	0.001	0.001
Maximum Value	65.98	269.18	9.55	14.10
Coefficient of Variation	2.21	3.12	1.51	2.19

14.4 Variography

Pairwise relative semivariograms were produced for both gold and silver in oxide and sulfide domains. The modelling procedure consisted of first examining the horizontal plane by producing semivariograms at azimuths of 90, 0, 45 and 135 degrees with dip 0 degrees. The vertical direction was also examined with this semivariogram setting the nugget effect. Once the direction of maximum continuity was established in the

horizontal plane the vertical plane perpendicular to this direction was examined. For both variables in both domains geometric anisotropy was demonstrated. In all cases, nested spherical models were fit to the data.

The semivariogram parameters are tabulated below in Table 14-6.

Table 14-6
Semivariogram Parameters for the Tiger Deposit

Domain	Variable	Az / Dip	C ₀	C ₁	C ₂	Short Range (m)	Long Range (m)
Oxides	Au	173 / 0	0.25	0.42	0.30	38.0	200.0
		83 / -55	0.25	0.42	0.30	20.0	68.0
		263 / -35	0.25	0.42	0.30	10.0	20.0
	Ag	173 / 0	0.20	0.30	0.50	15.0	50.0
		83 / -55	0.20	0.30	0.50	8.0	22.0
		263 / -35	0.20	0.30	0.50	10.0	32.0
Sulfides	Au	135 / 0	0.10	0.16	0.55	15.0	60.0
		45 / 0	0.10	0.16	0.55	15.0	25.0
		0 / -90	0.10	0.16	0.55	10.0	60.0
	Ag	0 / 0	0.10	0.30	0.40	50.0	120.0
		90 / 0	0.10	0.30	0.40	20.0	80.0
		0 / -90	0.10	0.30	0.40	8.0	20.0

14.5 Block Model

A block model with blocks 10 x 10 x 5 meters in dimension was superimposed over the mineralized solids. The model was rotated to match the drill hole fences. The block model origin and details follow:

Lower Left Corner of model

528619 E

Size of Column – 10 m

37 columns

7118717 N

Size of Row – 10 m

80 rows

Top of Model

1520 Elevation

Size of Level – 5 m

100 levels

X axis rotated 42 degrees counter clockwise

For each block the percentage below surface topography, below overburden and within each mineralized solid was recorded. Figure 14-4 shows the various mineralized solids with the overburden and topographic surfaces.

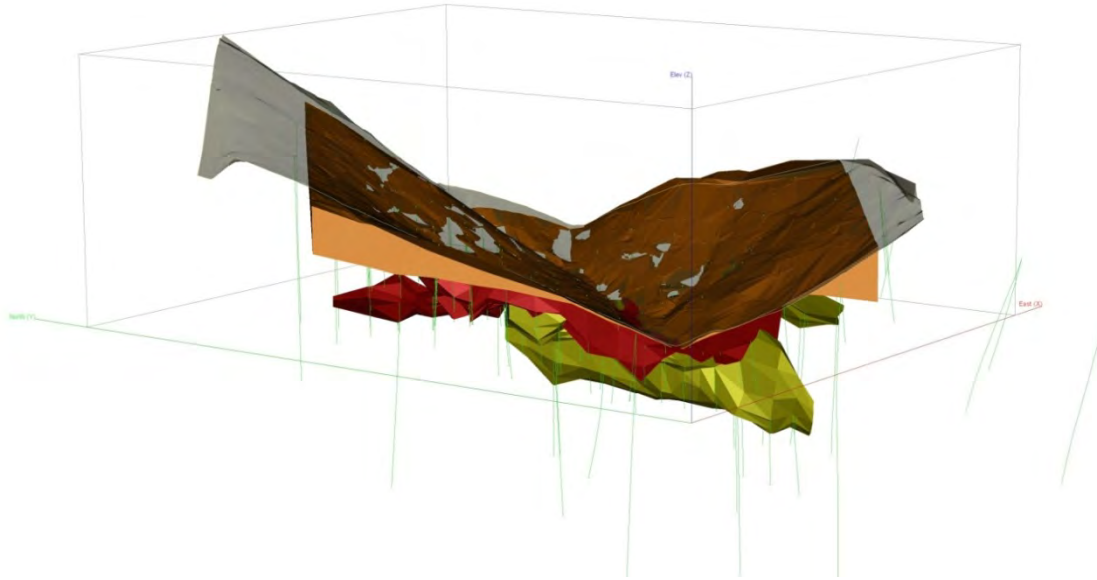

Figure 14-4
View Looking NE Showing Oxide Solids in Red, Sulfide Solids in Yellow,
Topography in Grey and Overburden in Orange

14.6 Bulk Density

Due to the extensive oxide content in this deposit and the inherent problems with measuring bulk density on soft, broken up oxide material, a lot of care and attention went into determining bulk density for the various units.

Representative densities for each lithology, alteration type and mineralization style were calculated by ATAC's consultants in the field using three methods; the first from weights in air from whole competent core, the second from measuring the weight of an entire box of core and the third measuring the weight of crushed, dried oxide material.

The first method was used most often. Several of these measurements were taken from each lithological unit within each hole. The second and third methods were used exclusively for oxidized material.

14.6.1 Weight in Air from Whole Competent Core

For the first method, 710 lengths of competent core were cut perpendicular to the core axis with a rock saw to ensure a cylindrical shape for accurate volume calculations. The final length of each cylinder was then measured to the nearest millimeter.

Volumes were calculated using the measured sample length and predetermined core diameters (84.61 mm for PQ, 60.68 mm for HQ, 50.34 mm for NQ and 41.59 mm for BTW core). Core diameters were determined by averaging numerous measurements taken on representative pieces of core using calipers accurate to 0.01 mm.

All weights were measured with an Ohaus Scout Pro digital scale to an accuracy of 0.1 grams. The scale was calibrated, leveled and zeroed prior to all measurements. Weight in air was measured first and then the sample was placed in a submerged metal basket suspended from a hook on the underside of the scale and weighed.

In air and in water weights were recorded along with the depth of the sample, its hole number, lithology, alteration and the percentage of sulfide mineralization if applicable.

To calculate density, the in air weight of the sample was divided by its volume. Specific gravity was also calculated using the Archimedes method from the sample weights in air and water. These calculations were used as a quality control check for the density calculations.

In general, specific gravity measurements are comparable to density measurements. Minor variations can be attributed to porosity and inaccuracy while measuring the volume of each sample. In addition, the Archimedes method also assumes the measurements were taken at sea level and with constant air and water temperatures.

Field measurements were taken roughly 1100 meters above sea level and under highly variable temperatures which could have affected specific gravity calculations. A scatterplot showing non oxide samples measured for both density and specific gravity is shown as Figure 13-5. No bias is indicated with a best fit regression line (black) mirroring the equal value line (blue). The coefficient of correlation is 0.901 showing good agreement. This means there is no significant porosity in the sulfide samples.

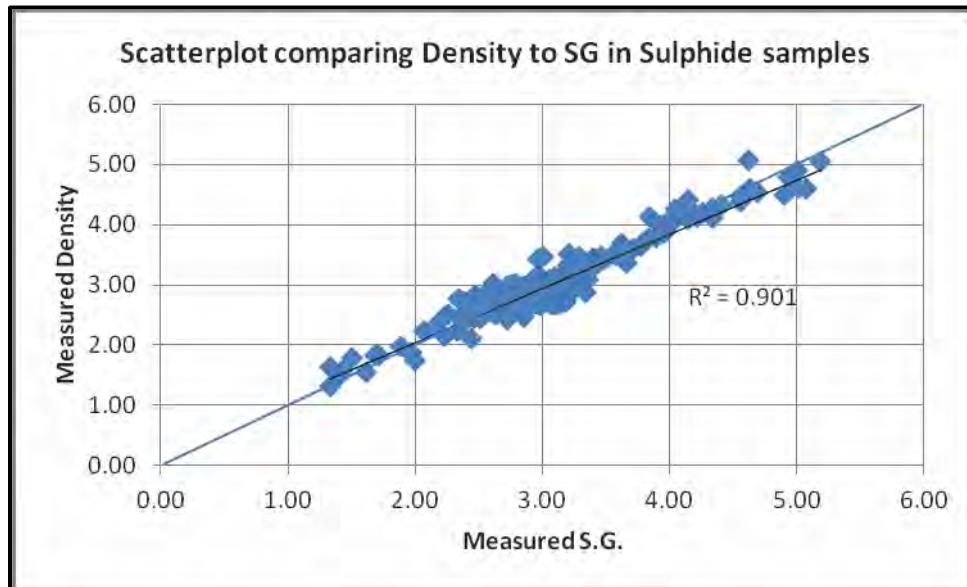

Figure 14-5
Scatterplot Comparing Density to SG in Sulfide Samples

14.6.2 Weight in Air of Entire Box of Core

Much of the oxidized core was too fragile to weigh using the above procedure; instead it was weighed in the core box. After geotechnical analysis, full boxes containing homogeneous intervals of oxide material were weighed using a bathroom scale. The weight of the box was subtracted from the measurement. The weight of each core box size was determined at the start of the program by taking an average weight of several boxes. To do these calculations, the length of core within the weighed box was measured. Some of the recovered core may be rubbly or broken, so estimation for measuring recovery may be required. The volume was then calculated assuming a perfect cylinder using predetermined core diameters and the measured length of core within the weighed box.

A high variability in the weights of core boxes, variations in recovery estimates, error in volume calculations, limited accuracy of a bathroom scale, and occasional excess drill mud in core boxes make box density calculations suspect and are only considered an approximation.

14.6.3 Weight of Crushed Dry Oxide Material

A third method to calculate density of oxide material was used later in the field season

when drill crews were consistently achieving high recoveries of oxide material. A total of 18 samples were collected from competent oxide material within intervals of 100% recovery that could be extracted from the core box. Lengths of oxide material were cut perpendicular to the core axis with sharp, metal edges. Cut sections were measured to the nearest millimeter prior to being extracted from the box. The volume of the sample was calculated from the same method described above. The sample was placed in a metal pan of known mass and was weighed using an Ohaus Scout Pro digital scale. The weight of the pan was subtracted from this measurement and the weight of the sample was recorded.

The initial sample weight includes the weight of water from natural ground conditions and fluids added during drilling and these samples are therefore considered saturated. To expedite drying, the sample was roasted in an oven at 400°C to remove all water. The sample was taken from the oven hourly and re-weighed until a consistent weight within the 0.1 gram error of the scale was achieved. This process would typically take 5-6 hours. The density of the sample was calculated at each stage using the previously defined method.

Because the oxide material could not be submerged, density calculations using the roasted method could not be checked against a specific gravity calculation. The most likely source of error in the roasting method would come from inaccurate measurements used in the volume calculations.

Oxidized core often contains significant pebbles and cobbles of limonite and goethite, this makes selection and extraction of representative intervals difficult. The amount of solid pieces within a particular interval of core can range from one or two pebbles per meter to nearly solid boxwork limonite. When selecting core for measurements, the uneven distribution of limonite and goethite produces a bias towards the softer, easier to cut and extract intervals. Although a close approximation, density results obtained from this method for oxidized core should be considered a minimum value and not entirely representative of more competent oxidized core.

The results are summarized in the table below.

**Table 14-7
Average Unit Density**

Unit	Modifier	Count	Avg	Min	Max	Comments
OX	Wet	65	2.38	1.81	3.10	
OX	Dry	18	1.80	1.25	2.37	Average 24% density loss after roasting
OX	Box	156	2.53	1.75	3.43	Using box weight method
DOL	MX	67	3.46	2.58	5.19	Mineralized Dolomite (incl. Tiger Zone)
DOL		35	2.98	2.71	3.36	Unaltered/Unmineralized Dolomite
LST		387	2.83	2.37	3.46	
LEP		38	2.94	2.75	3.33	
VOL		78	2.93	2.60	3.30	Not including partially oxidized VOL
MBL		40	2.79	2.52	3.05	

14.6.4 Sintrex Graviglog BHG system

A fourth and relatively new method of determining density was conducted by Scintrex using a Borehole Gravity Meter (Seigel et. al, 2009). The new Scintrex Graviglog BHG system can be deployed down drill holes to determine the bulk density determination of formations intersected by the borehole. This methodology was tried on 8 drill holes through oxide material during the 2010 drill program.

**Table 14-8
Average Unit Density – Scintrex**

Unit	Count	Avg	Min	Max
OX	80	2.46	1.62	3.36
HOST ROCKS	114	2.71	1.96	3.73

As some of the holes tested by Scintrex were outside the mineralized zone, a better comparison is made by comparing intervals from holes sampled by both ATAC's consultants and Scintrex. Figure 13-6 shows a scatterplot comparing density in intervals measure by both ATAC and Scintrex. These were not exactly the same intervals, however, as the Scintrex method was over intervals from 2 to 10 m while the ATAC samples were from small pieces of drill core contained within the Scintrex interval. The plot shows no bias with samples plotting on either side of an equal value line.

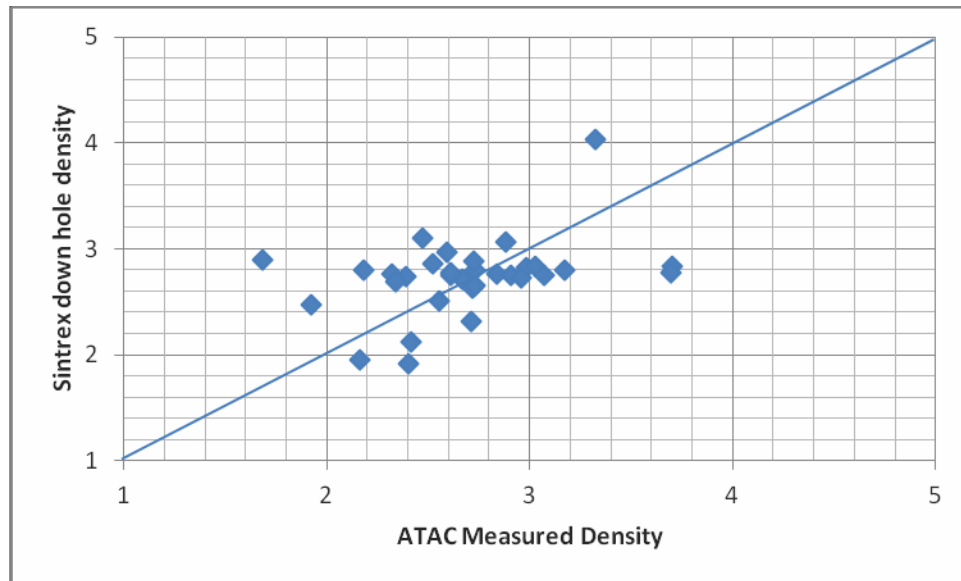

Figure 14-6

Scatterplot Showing ATAC Measured Density Compared to Scintrex Density

14.6.5 Conclusions

Deposits containing significant oxide horizons present a challenge to bulk density determinations. The standard methods of measuring a sample in air and again in water do not work on this soft often poorly consolidated material. A number of different methods were tried on the Tiger Deposit oxide samples. The results from method 1, using a measured volume and a weight in air seem reasonable when compared to other methods. For the purpose of this resource estimate a density of 2.38 was used for oxide material. For the mineralized dolomite unit (mineralized sulfide domain) a value of 3.38 was used which represents the average of 63 samples within the limits of two standard deviations above and below the mean of all mineralized Dolomite samples. The material outside the mineralized solids was assigned a density of 2.86 the average of 578 samples outside the solids.

14.7 Grade Interpolation

Grades for gold and silver were interpolated into the block model using Ordinary Kriging. The kriging exercise was completed four times, once each for gold and silver in blocks containing some percentage within the oxide solids and again for gold and silver in blocks containing some percentage within the sulfide mineralized solids. For kriging

in oxides only oxide composites were used and for estimating grades in sulfides only sulfide composites were used.

The kriging exercise was completed for each variable in each domain in a series of four passes. Pass 1 used a search ellipse with dimensions equal to $\frac{1}{4}$ of the semivariogram range in each of the three principal directions. A minimum of four composites with a maximum of three coming from any one hole was required to estimate the block. For blocks not estimated in pass 1, a second pass using search ellipse dimensions equal to $\frac{1}{2}$ the semivariogram range was completed. Pass 3 using the full range and pass 4 using twice the range rounded out the exercise. In all cases if more than 12 composites were found the closest 12 were used.

For blocks containing some percentage of both oxide and sulfide material a weighted average was made. Since the ranges for silver in oxides were less than the ranges for gold, the pass 4 distances for silver were set to the pass 4 distances for gold. This ensured all blocks estimated for gold had a silver value. The parameters for the Ordinary Kriging runs are tabulated below.

Table 14-9
Kriging Parameters for the Tiger Deposit

Domain	Variable	Pass	Number Estimated	Az / Dip	Dist. (m)	Az / Dip	Dist. (m)	Az / Dip	Dist. (m)
Oxides 100% of Blocks Estimated	Au	1	2,726	172 / 0	50.0	83 / -55	17.0	263 / -35	5.0
		2	4,198	172 / 0	100.0	83 / -55	34.0	263 / -35	10.0
		3	1,532	172 / 0	200.0	83 / -55	68.0	263 / -35	20.0
		4	90	172 / 0	400.0	83 / -55	136.0	263 / -35	40.0
	Ag	1	61	172 / 0	12.5	83 / -55	5.5	263 / -35	8.0
		2	1,548	172 / 0	25.0	83 / -55	11.0	263 / -35	16.0
		3	4,482	172 / 0	50.0	83 / -55	22.0	263 / -35	32.0
		4	2,455	172 / 0	400.0	83 / -55	136.0	263 / -35	40.0
Sulfides 98.8 % of Blocks Estimated	Au	1	44	135 / 0	15.0	45 / 0	6.25	0 / -90	15.0
		2	2,018	135 / 0	30.0	45 / 0	12.5	0 / -90	30.0
		3	6,019	135 / 0	60.0	45 / 0	25.0	0 / -90	60.0
		4	2,320	135 / 0	120.0	45 / 0	50.0	0 / -90	120.0
	Ag	1	1,222	135 / 0	30.0	45 / 0	20.0	0 / -90	5.0
		2	5,964	135 / 0	60.0	45 / 0	40.0	0 / -90	10.0
		3	2,744	135 / 0	120.0	45 / 0	80.0	0 / -90	20.0
		4	471	135 / 0	240.0	45 / 0	160.0	0 / -90	40.0

14.8 Classification

Based on the study herein reported, delineated mineralization for the Tiger Deposit, Rau Property is classified as a resource according to the following definitions from National Instrument 43-101 and from CIM (2005):

“In this Instrument, the terms "mineral resource", "inferred mineral resource", "indicated mineral resource" and "measured mineral resource" have the meanings ascribed to those terms by the Canadian Institute of Mining, Metallurgy and Petroleum, as the CIM Definition Standards on Mineral Resources and Mineral Reserves adopted by CIM Council, as those definitions may be amended.”

The terms Measured, Indicated and Inferred are defined by CIM (2005) as follows:

“A Mineral Resource is a concentration or occurrence of diamonds, natural solid inorganic material, or natural solid fossilized organic material including base and precious metals, coal and industrial minerals in or on the Earth’s crust in such form and quantity and of such a grade or quality that it has reasonable prospects for economic extraction. The location, quantity, grade, geological characteristics and continuity of a Mineral Resource are known, estimated or interpreted from specific geological evidence and knowledge.”

“The term Mineral Resource covers mineralization and natural material of intrinsic economic interest which has been identified and estimated through exploration and sampling and within which Mineral Reserves may subsequently be defined by the consideration and application of technical, economic, legal, environmental, socio-economic and governmental factors. The phrase ‘reasonable prospects for economic extraction’ implies a judgement by the Qualified Person in respect of the technical and economic factors likely to influence the prospect of economic extraction. A Mineral Resource is an inventory of mineralization that under realistically assumed and justifiable technical and economic conditions might become economically extractable. These assumptions must be presented explicitly in both public and technical reports.”

Inferred Mineral Resource

“An ‘Inferred Mineral Resource’ is that part of a Mineral Resource for which quantity and grade or quality can be estimated on the basis of

geological evidence and limited sampling and reasonably assumed, but not verified, geological and grade continuity. The estimate is based on limited information and sampling gathered through appropriate techniques from locations such as outcrops, trenches, workings and drill holes.”

“Due to the uncertainty that may be attached to Inferred Mineral Resources, it cannot be assumed that all or any part of an Inferred Mineral Resource will be upgraded to an Indicated or Measured Mineral Resource as a result of continued exploration. Confidence in the estimate is insufficient to allow the meaningful application of technical and economic parameters or to enable an evaluation of economic viability worthy of public disclosure. Inferred Mineral Resources must be excluded from estimates forming the basis of feasibility or other economic studies.”

Geologic continuity for the deposit has been established through geologic mapping and drill hole logging. The geologic continuity has been used to constrain the oxide and sulfide mineralized domains. The grade continuity, which can be quantified by semivariograms, can be used to classify the estimate.

Blocks with gold estimated in Pass 1 or 2 using search ellipses of up to ½ the semivariogram range were considered Indicated. All other blocks were classified as Inferred at this time. Figure 14-7 shows blocks classified as Indicated and Inferred. The resource is tabulated by Classification in Tables 14-10 and 11 and then broken into Oxide Zone in Tables 14-12 and 13 and Sulfide Zone in Tables 14-14 and 15. While no economic cut-off is known at this time a cut-off of 0.3 g/t is highlighted as a possible open pit cut-off. Note, due to rounding off, the totals for all blocks might not equal exactly the sums of oxides plus sulfides.

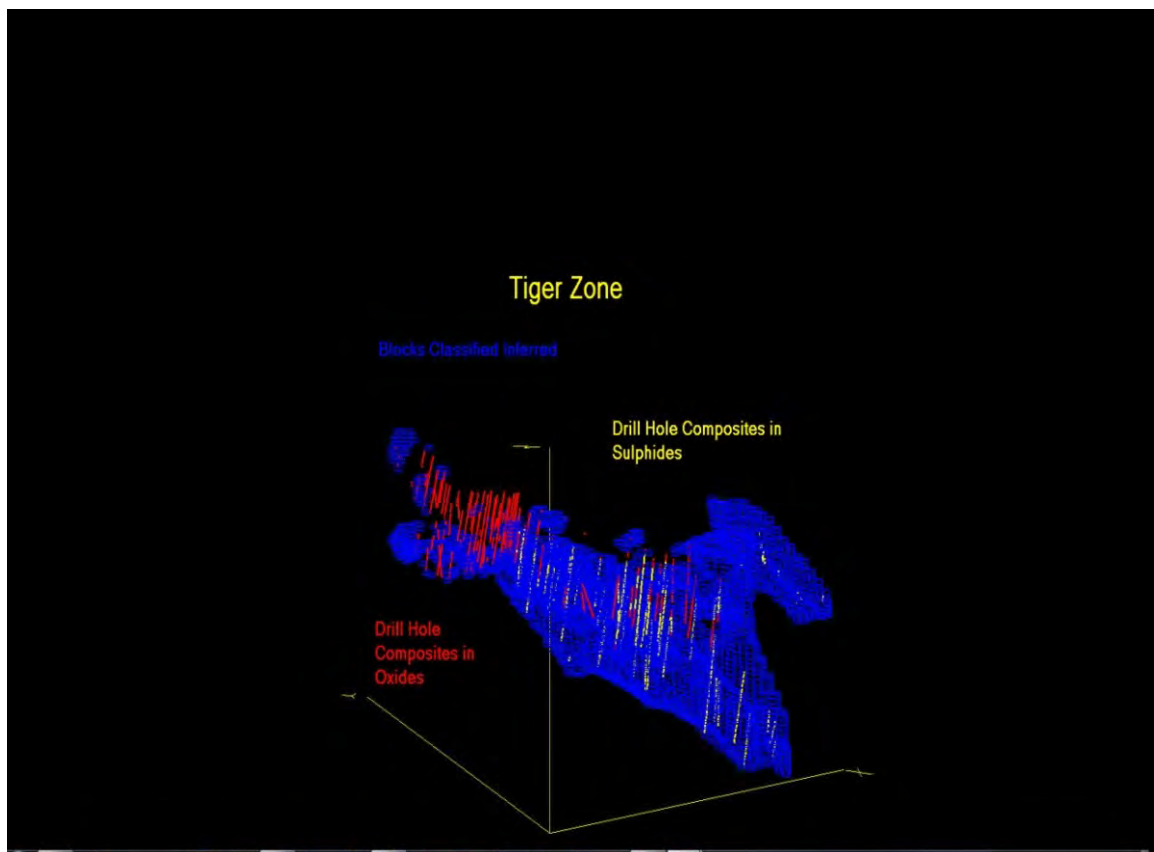
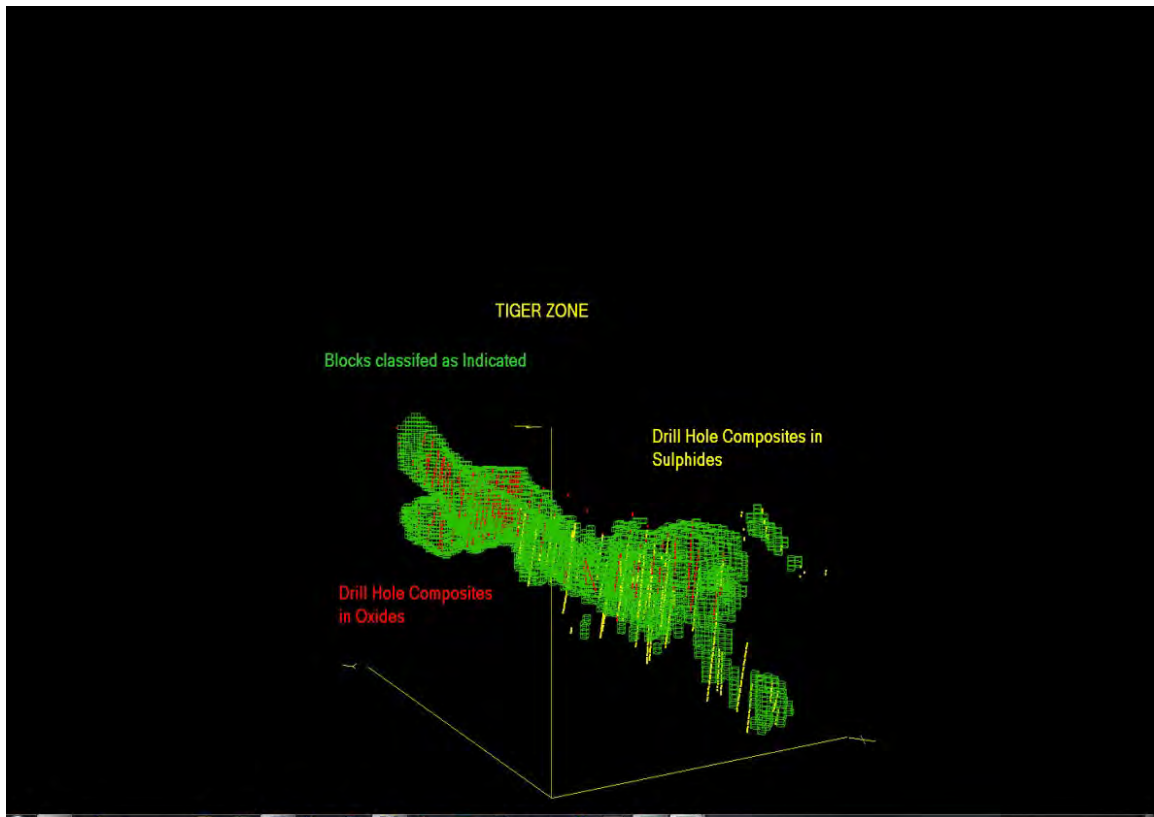

Figure 14-7
Isometric Views Looking NE Showing Classified Blocks

Table 14-10
Tiger Deposit All Blocks - Classified Indicated

Au Cut-off (g/t)	Tonnes > Cut-off (tonnes)	Grade > Cut-off		Contained Metal	
		Au (g/t)	Ag (g/t)	Au (ozs)	Ag (ozs)
0.10	8,180,000	1.96	3.82	515,500	1,004,600
0.20	7,700,000	2.07	3.76	512,500	930,800
0.30	7,150,000	2.21	3.68	508,000	846,000
0.40	6,650,000	2.35	3.65	502,400	780,400
0.50	6,220,000	2.49	3.68	498,000	735,900
0.60	5,850,000	2.61	3.71	490,900	697,800
0.70	5,500,000	2.73	3.80	482,800	672,000
0.80	5,190,000	2.85	3.84	475,600	640,800
0.90	4,830,000	3.00	3.90	465,900	605,600
1.00	4,550,000	3.13	3.98	457,900	582,200
1.20	4,070,000	3.36	4.10	439,700	536,500
1.40	3,680,000	3.58	4.19	423,600	495,700
1.60	3,260,000	3.85	4.26	403,500	446,500
1.80	2,940,000	4.09	4.23	386,600	399,800
2.00	2,640,000	4.34	4.24	368,400	359,900

Table 14-11
Tiger Deposit All Blocks - Classified Inferred

Au Cut-off (g/t)	Tonnes > Cut-off (tonnes)	Grade > Cut-off		Contained Metal	
		Au (g/t)	Ag (g/t)	Au (ozs)	Ag (ozs)
0.10	9,780,000	0.95	1.02	298,700	320,700
0.20	9,090,000	1.01	1.02	295,200	298,100
0.30	8,280,000	1.09	0.94	290,200	250,200
0.40	7,470,000	1.17	0.86	281,000	206,500
0.50	6,620,000	1.26	0.86	268,200	183,000
0.60	5,700,000	1.37	0.91	251,100	166,800
0.70	4,920,000	1.49	0.95	235,700	150,300
0.80	4,280,000	1.60	0.97	220,200	133,500
0.90	3,720,000	1.71	0.98	204,500	117,200
1.00	3,180,000	1.84	1.00	188,100	102,200
1.20	2,480,000	2.05	1.01	163,500	80,500
1.40	2,000,000	2.24	1.06	144,000	68,200
1.60	1,570,000	2.44	1.05	123,200	53,000
1.80	1,270,000	2.61	0.92	106,600	37,600
2.00	1,010,000	2.80	0.83	90,900	27,000

Table 14-12
Tiger Deposit Oxide Blocks - Classified Indicated

Au Cut-off (g/t)	Tonnes > Cut-off (tonnes)	Grade > Cut-off		Contained Metal	
		Au (g/t)	Ag (g/t)	Au (ozs)	Ag (ozs)
0.10	5,080,000	2.42	5.77	395,300	942,400
0.20	4,790,000	2.56	5.66	394,300	871,700
0.30	4,490,000	2.71	5.49	391,200	792,500
0.40	4,200,000	2.88	5.42	388,900	731,900
0.50	3,970,000	3.02	5.42	385,000	691,800
0.60	3,800,000	3.13	5.41	382,400	661,000
0.70	3,640,000	3.24	5.46	379,200	639,000
0.80	3,480,000	3.35	5.47	374,800	612,000
0.90	3,300,000	3.49	5.46	370,300	579,300
1.00	3,150,000	3.61	5.52	365,600	559,000
1.20	2,900,000	3.82	5.54	356,200	516,500
1.40	2,700,000	4.02	5.54	349,000	480,900
1.60	2,470,000	4.25	5.47	337,500	434,400
1.80	2,260,000	4.48	5.36	325,500	389,500
2.00	2,080,000	4.72	5.29	315,600	353,800

Table 14-13
Tiger Deposit Oxide Blocks - Classified Inferred

Au Cut-off (g/t)	Tonnes > Cut-off (tonnes)	Grade > Cut-off		Contained Metal	
		Au (g/t)	Ag (g/t)	Au (ozs)	Ag (ozs)
0.10	790,000	1.17	6.17	29,700	156,700
0.20	740,000	1.23	5.96	29,300	141,800
0.30	620,000	1.42	5.31	28,300	105,800
0.40	500,000	1.67	4.51	26,800	72,500
0.50	440,000	1.85	4.46	26,200	63,100
0.60	420,000	1.91	4.51	25,800	60,900
0.70	400,000	1.97	4.54	25,300	58,400
0.80	380,000	2.05	4.51	25,000	55,100
0.90	350,000	2.15	4.35	24,200	49,000
1.00	320,000	2.27	4.35	23,400	44,800
1.20	250,000	2.59	4.56	20,800	36,700
1.40	220,000	2.73	4.48	19,300	31,700
1.60	180,000	3.00	3.92	17,400	22,700
1.80	150,000	3.29	3.37	15,900	16,300
2.00	130,000	3.53	2.73	14,800	11,400

**Table 14-14
Tiger Deposit Sulfide Blocks - Classified Indicated**

Au Cut-off (g/t)	Tonnes > Cut-off (tonnes)	Grade > Cut-off		Contained Metal	
		Au (g/t)	Ag (g/t)	Au (ozs)	Ag (ozs)
0.10	3,060,000	1.20	0.58	118,100	57,100
0.20	2,830,000	1.29	0.58	117,400	52,800
0.30	2,590,000	1.38	0.57	114,900	47,500
0.40	2,360,000	1.48	0.55	112,300	41,700
0.50	2,180,000	1.57	0.54	110,000	37,800
0.60	1,990,000	1.67	0.53	106,800	33,900
0.70	1,810,000	1.77	0.51	103,000	29,700
0.80	1,660,000	1.86	0.50	99,300	26,700
0.90	1,480,000	1.98	0.49	94,200	23,300
1.00	1,360,000	2.07	0.50	90,500	21,900
1.20	1,140,000	2.26	0.52	82,800	19,100
1.40	960,000	2.44	0.52	75,300	16,000
1.60	760,000	2.69	0.53	65,700	13,000
1.80	650,000	2.86	0.51	59,800	10,700
2.00	550,000	3.04	0.51	53,800	9,000

**Table 14-15
Tiger Deposit Sulfide Blocks - Classified Inferred**

Au Cut-off (g/t)	Tonnes > Cut-off (tonnes)	Grade > Cut-off		Contained Metal	
		Au (g/t)	Ag (g/t)	Au (ozs)	Ag (ozs)
0.10	8,990,000	0.93	0.57	268,800	164,800
0.20	8,320,000	1.00	0.58	267,500	155,100
0.30	7,640,000	1.06	0.59	260,400	144,900
0.40	6,950,000	1.13	0.60	252,500	134,100
0.50	6,170,000	1.22	0.61	242,000	121,000
0.60	5,260,000	1.33	0.62	224,900	104,900
0.70	4,520,000	1.45	0.63	210,700	91,600
0.80	3,910,000	1.56	0.63	196,100	79,200
0.90	3,370,000	1.67	0.63	180,900	68,300
1.00	2,870,000	1.80	0.63	166,100	58,100
1.20	2,230,000	2.00	0.62	143,400	44,500
1.40	1,770,000	2.18	0.64	124,100	36,400
1.60	1,380,000	2.37	0.67	105,200	29,700
1.80	1,120,000	2.53	0.59	91,100	21,200
2.00	880,000	2.71	0.54	76,700	15,300

While the original block model was created from 10 x 10 x 5 m blocks it was later re-blocked for mine planning to 5 x 5 x 5 m blocks. This was done since the mine planning software required using whole blocks and the 10 x 10 x 5 m blocks on the edges of the mineralized zone brought in more dilution than was necessary. The grade interpolation has not changed from the original estimate with individual 10 x 10 x 5 m blocks being sub divided into four 5 x 5 x 5 m blocks at the same grade. The percentage of mineralized material and waste within each of the new blocks was recalculated from the same solids used for the 10 x 10 x 5 m block model. As a result there was no material change to grade, tonnes of mineralized material or waste or contained ounces.

15.0 MINERAL RESERVE ESTIMATES

A mineral reserve has not been estimated for the Project as part of this PEA.

A mineral reserve is the economically mineable part of a Measured or Indicated Mineral Resource.

16.0 MINING METHODS

The PEA is preliminary in nature and includes Inferred Mineral Resources that are considered too speculative geologically to have the economic considerations applied to them that would enable them to be categorized as mineral reserves. Furthermore, there is no certainty that the PEA results will be realized.

16.1 Introduction

ATAC commissioned Tetra Tech to prepare a PEA-level mining study for the Tiger Gold Project located in Yukon, Canada. The mining study was based on a nominal process capacity of approximately 520,000 t/a. This section outlines the input data, procedures and results of this PEA-level pit optimization, design, mining scheduling, mine equipment, and labor requirements.

16.2 Pit Optimization

Tetra Tech performed the open pit optimizations and mine production scheduling using GEOVIA Whittle™ software, which is based on the Lerchs-Grossmann (“LG”) algorithm. Tetra Tech prepared pit optimization parameters based on inputs from other engineering consultants retained by ATAC, such as the mineral processing and the pit geotechnical, technical studies, and experience from other projects.

16.2.1 Block Model

ATAC provided Tetra Tech with a 5 m by 5 m by 5 m block model in CSV format. Details of the resource estimation and block modelling are documented in Section 14.0. This block model forms the basis of this mining study.

16.2.2 Pit Slope Angle

Golder Associates Inc. (“Golder”) completed a scoping level pit slope evaluation report entitled “Tiger Zone Project – Yukon Territory, Canada” dated January 27, 2014.

Table 16-1 lists the scoping-level pit slope design recommendations as proposed by Golder.

**Table 16-1
Scoping-level Pit Slope Design Recommendations**

Geotechnical Unit	Inter-ramp Slope Angle	Assumptions
Carbonate Rock (Limestone, Dolomite, Marble) Volcaniclastic Rock	45°	<ul style="list-style-type: none"> • Trim Blasting • Bench Height = 10 m (double benching) • Bench Face Angle = 70° • Minimum Catch Bench Width = 6.5 m
Oxide (<30 m high)	40°	<ul style="list-style-type: none"> • Buffer blasting (if required to loosen the oxide) • Trim bench face by machine • Bench Height = 10 m • Bench Face Angle = 63° • Minimum Catch Bench Width = 6.5 m
Oxide (>30 m high)	35°	<ul style="list-style-type: none"> • Buffer blasting (if required to loosen the oxide) • Bench faces trimmed by dozer or excavator • Bench Height = 10 m • Bench Face Angle = 63° • Minimum Catch Bench Width = 10 m

16.2.3 Surface Topography

ATAC provided digital topographical drawings to Tetra Tech. The Project topography is shown in Figure 16-1.

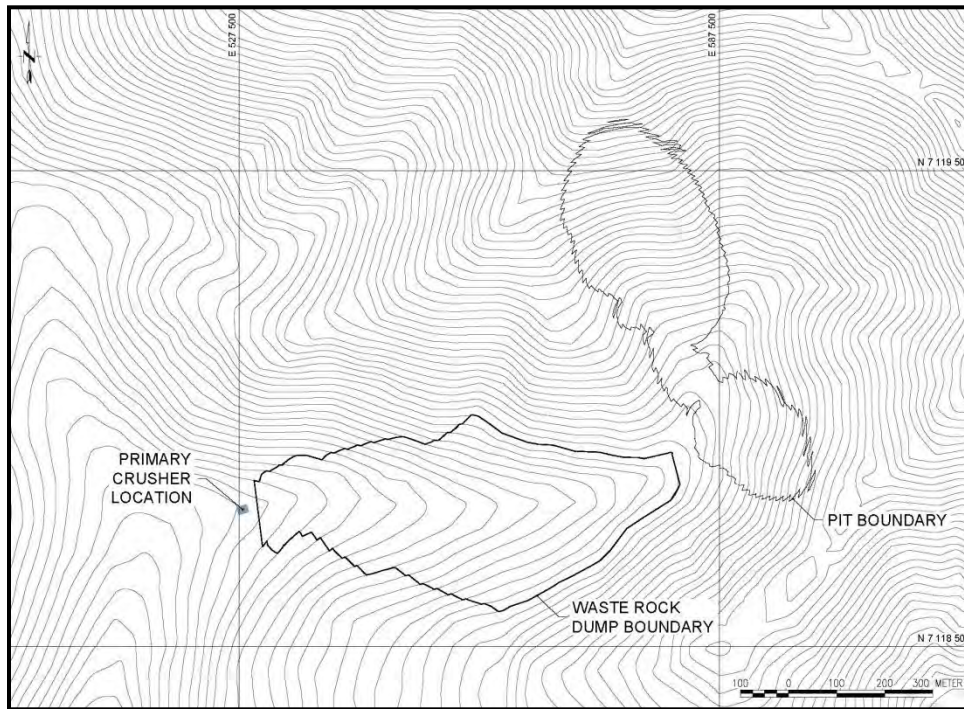

Figure 16-1
Tiger Gold Project Topography

16.2.4 Pit Optimization Parameters

Table 16-2 lists the pit optimization parameters.

Table 16-2
Pit Optimization Parameters

Items	Units	Value
Exchange Rate	CAD = USD	0.92
Discount Rate	%	5
Production Rate		
Daily Processing Capacity	t/d	3,300
Working Days	d/a	158
Yearly Processing Capacity	t/a	520,000
Metal Price (Market)		
Gold	USD/oz	1,250
Process		
Method		Hybrid
Recovery	%	89.90
Off-site Costs		
Refining Cost - Au Dore	USD/oz	1.00
Percent Payment	%	99.50

Items	Units	Value
Transportation (insurance & security included) - Au Dore	USD/oz	5.00
Private Royalty	%	0.00
Operating Cost		
<i>Mining:</i>		
Oxides	\$/t mined	5.75
Waste	\$/t mined	6.25
<i>Processing and G&A:</i>		
G&A	\$/t processed	6.83
Heap Leach	\$/t processed	2.42
CIL, Strip and Refining	\$/t processed	26.99
Leach Pad and Tails Dam Ongoing Expansions	\$/t processed	13.18
Total Processing and G&A	\$/t processed	49.42
Block Model		
Block Model	m	5 x 5 x 5
Percentage of Oxides in Each Block	%	Variable
Gold Grade	g/t	Variable
Density		
Oxide Mineralization	t/m ³	2.38
Sulfide Mineralization	t/m ³	3.38
Waste	t/m ³	2.86
Overburden	t/m ³	2.86
Default	t/m ³	2.86
Mining Technical Assumptions		
Mining Recovery	%	95
Mining Dilution	%	5
Pit Slope Angles		
Inter-ramp (Oxides)	degrees	35
Inter-ramp (Carbonate rock; Volcaniclastic rock)	degrees	45

16.2.5 Pit Optimization Results

Using the provided block model, pit slope angles and pit optimization parameters outlined in Table 16-2, 53 pit shells were generated using GEOVIA Whittle™ software, corresponding to price factors ranging between 0.2 and 1.5. Pit optimizations have been performed using the Indicated and Inferred oxide resources while sulfide resources have been treated as waste. The discounted value of each pit was estimated by Whittle using a 5% discount rate based on the exchange rate, gold price, process recovery, operating costs and marketing terms listed in Table 16-2. No capital costs were considered in generating these discounted values.

The results of pit optimizations are provided in Table 16-3. Based on the discounted value, Pit 42 (corresponding to a 0.95 revenue factor) was selected to be the ultimate pit for further detailed designs and production scheduling.

**Table 16-3
Pit Optimization Results**

Pit	Total Material Mined (t)	Waste Mined (t)	Mineralized Material Mined (t)	Au Grade (g/t)	Strip Ratio	Discounted Value at 5%
1	759	98	661	7.46	0.15	\$154,591
2	5,214	1,380	3,834	5.54	0.36	\$605,400
3	5,397	1,380	4,017	5.53	0.34	\$633,346
4	11,078	5,288	5,790	5.53	0.91	\$891,786
5	15,299	7,630	7,669	5.36	0.99	\$1,126,831
6	71,104	47,819	23,285	4.97	2.05	\$2,913,229
7	139,929	82,567	57,362	4.27	1.44	\$5,828,680
8	292,777	147,957	144,820	3.78	1.02	\$12,256,756
9	382,335	204,222	178,113	3.77	1.15	\$14,845,010
10	392,532	207,466	185,066	3.75	1.12	\$15,274,450
11	421,696	226,294	195,402	3.74	1.16	\$15,990,029
12	443,313	237,103	206,210	3.72	1.15	\$16,716,580
13	541,158	306,604	234,554	3.72	1.31	\$18,806,334
14	592,486	340,780	251,706	3.71	1.35	\$20,006,704
15	594,882	342,581	252,301	3.71	1.36	\$20,058,471
16	599,134	344,397	254,737	3.71	1.35	\$20,207,109
17	603,073	346,486	256,587	3.71	1.35	\$20,335,441
18	609,168	349,225	259,943	3.70	1.34	\$20,525,265
19	653,327	372,309	281,018	3.65	1.32	\$21,656,031
20	656,179	374,270	281,909	3.65	1.33	\$21,717,434
21	722,808	419,884	302,924	3.64	1.39	\$23,033,128
22	777,834	452,697	325,137	3.60	1.39	\$24,206,533
23	867,459	524,500	342,959	3.62	1.53	\$25,483,209
24	1,067,113	661,320	405,793	3.57	1.63	\$29,008,012
25	1,074,183	664,426	409,757	3.56	1.62	\$29,187,708
26	1,102,850	680,365	422,485	3.54	1.61	\$29,708,373
27	5,431,630	4,430,817	1,000,813	4.11	4.43	\$73,124,872
28	5,529,776	4,498,536	1,031,240	4.09	4.36	\$74,609,353
29	5,640,544	4,590,488	1,050,056	4.09	4.37	\$75,824,582
30	5,646,518	4,594,667	1,051,851	4.08	4.37	\$75,923,481
31	5,698,221	4,638,851	1,059,370	4.09	4.38	\$76,421,040
32	5,714,409	4,648,282	1,066,127	4.08	4.36	\$76,717,217
33	5,718,069	4,650,970	1,067,099	4.08	4.36	\$76,769,690
34	5,800,109	4,708,733	1,091,376	4.06	4.31	\$77,906,862
35	6,777,233	5,506,607	1,270,626	3.99	4.33	\$86,504,881
36	8,883,524	7,374,448	1,509,076	4.01	4.89	\$97,980,372

Pit	Total Material Mined (t)	Waste Mined (t)	Mineralized Material Mined (t)	Au Grade (g/t)	Strip Ratio	Discounted Value at 5%
37	9,712,122	8,093,789	1,618,333	3.98	5.00	\$101,852,700
38	9,997,627	8,327,335	1,670,292	3.95	4.99	\$103,143,849
39	11,094,386	9,290,909	1,803,477	3.90	5.15	\$105,869,069
40	12,102,802	10,171,033	1,931,769	3.84	5.27	\$107,517,549
41	12,282,113	10,317,673	1,964,440	3.82	5.25	\$107,731,701
42	12,912,355	10,859,734	2,052,621	3.77	5.29	\$108,183,069
43	13,651,694	11,536,969	2,114,725	3.75	5.46	\$108,125,887
44	14,158,085	11,994,376	2,163,709	3.73	5.54	\$107,737,125
45	14,882,867	12,644,357	2,238,510	3.69	5.65	\$106,934,169
46	15,343,853	13,064,824	2,279,029	3.68	5.73	\$106,302,721
47	15,491,711	13,200,700	2,291,011	3.67	5.76	\$106,026,374
48	15,673,207	13,367,510	2,305,697	3.66	5.80	\$105,634,603
49	16,526,026	14,163,287	2,362,739	3.64	5.99	\$103,637,054
50	16,757,214	14,371,559	2,385,655	3.63	6.02	\$102,901,023
51	17,396,934	14,988,044	2,408,890	3.63	6.22	\$101,354,749
52	17,662,091	15,237,899	2,424,192	3.63	6.29	\$100,562,297
53	17,735,372	15,306,415	2,428,957	3.63	6.30	\$100,286,214

16.3 Mine Design

16.3.1 Bench Height and Pit Wall Slope

Based on the geotechnical parameters provided in Table 16-1, the final pit design incorporates a bench height of 10 m, a 45° overall slope angle in the waste rock and a 32° overall slope angle in the oxide material. The overall slope angle of the oxide material is 3° less than the inter-ramp slope angle in Table 16-1 to account for the ramps. No ramps will be built in the high wall, and thus no reduction is necessary to the waste rock inter-ramp angle.

16.3.2 Minimum Working Area

Benches have been designed to accommodate a 6.5 m³ excavator and a 39-t articulated truck.

16.3.3 Haul Road

Main haul roads for the pit area were designed to accommodate 39-t articulated trucks with two-way traffic in most of the haulage roads and one-way traffic for the last 2 to 3 benches at the pit bottom. In-pit ramps were designed with a maximum grade of 10%. With the flexibility offered by the articulated trucks, haul roads outside the pit are assumed to have a maximum grade of 20%. The widths of the one-way and two-way traffic were set to be 8 m and 15 m, respectively.

16.3.4 Pit Hydrology/Dewatering

No detailed investigation of pit hydrology/dewatering was included in this PEA; however, an allowance is included in the mining operating cost to account for pit dewatering costs.

16.3.5 Pit Design Results

The final designed pit includes 2 Mt of mineral resource with a LOM strip ratio of 5.58. A material summary for the final pit is provided in Table 16-4. Figure 16-2 shows a general view of the final pit.

**Table 16-4
Pit Design Results**

Material	Tonnage	Au (g/t)
Mineralized Material	2,063,422	3.72
Waste (Rock and Low Grade Oxide)	11,509,872	-

16.3.6 Material Handling

Mineralized material from the oxide resources above the economic cut-off will be trucked to the primary crusher, located at the south-west side of the open pit and waste dump area. Haulage truck requirements have been defined by the average haulage profiles for each year. Crushed material will then be conveyed to the processing location.

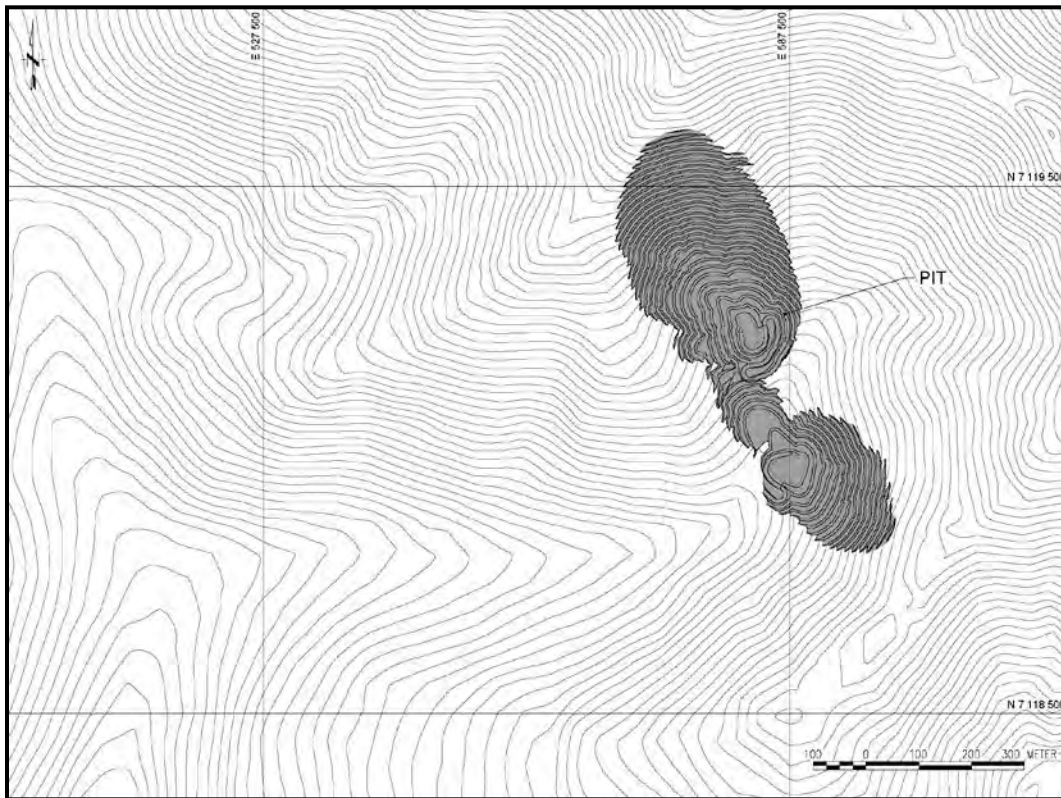

Figure 16-2
Ultimate Pit Design

16.4 Production Schedule

The mining schedule was developed based on a nominal processing capacity of 3,300 t/d for 158 d/a. Only oxide material above the economic cut-off will be scheduled for processing. Oxide material below the economic cut-off and all sulfide material will be handled as waste. The developed production schedule maximizes the NPV of the Project by targeting higher-grade resources earlier in the mine life. A cut-off grade policy was applied based on which the relatively low grade material in excess of the processing capacity in a particular production year is stockpiled and reclaimed in later years when pit production of mineralized material is low. Relatively high grade material will be sent directly to the primary crusher, located southwest of the pit, at the toe of the waste dump. Low grade stockpile material will be stored close to the primary crusher. Waste material will be stored in a WD located between the pit and primary crusher.

The Project's total mine life is 5 years, including 1 year of pre-stripping followed by 4 years of production. The production schedule is shown in Table 16-5 and Figure 16-3. Over the 5-year mine life, the pit will produce 2 Mt of mineralized material and 11.5 Mt

of waste rock. The LOM average gold grade is 3.72 g/t. The LOM stripping ratio (defined as waste material mined divided by mineralized material mined) is 5.58. Figure 16-4 shows the status of mining activity at the end of mine life.

**Table 16-5
Production Schedule**

Year	Mine to Process (t)	Mine to Stockpile (t)	Stockpile to Process (t)	Material Processed (t)	Head Grade (g/t)	Waste (t)	Total Mined (t)	Strip Ratio	Material in Stockpile (t)
-1	-	437,645	-	-	-	1,062,355	1,500,000	2.43	437,645
1	196,798	266,101	319,402	516,200	5.27	3,137,101	3,600,000	6.78	384,344
2	138,696	93,227	377,504	516,200	3.21	3,368,076	3,600,000	14.52	100,068
3	415,916	79,138	100,068	515,984	3.79	3,104,947	3,600,000	6.27	79,138
4	435,901	0	79,138	515,038	2.61	837,393	1,273,294	1.92	-
Total	1,187,311	876,111	876,112	2,063,422	3.72	11,509,872	13,573,294	5.58	-

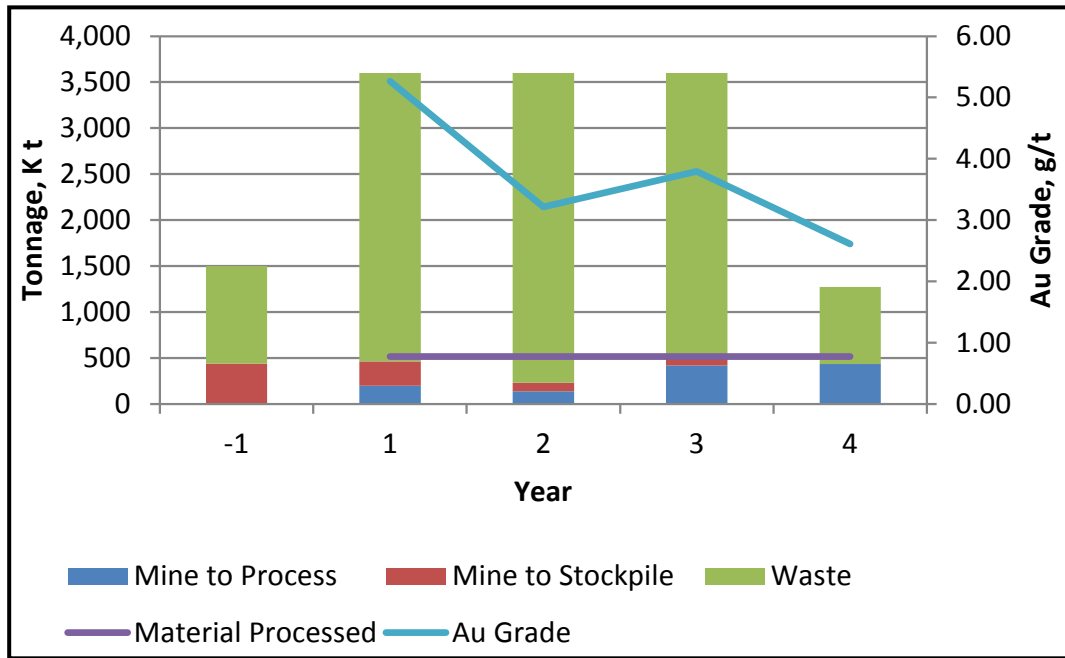

Figure 16-3
Production Schedule

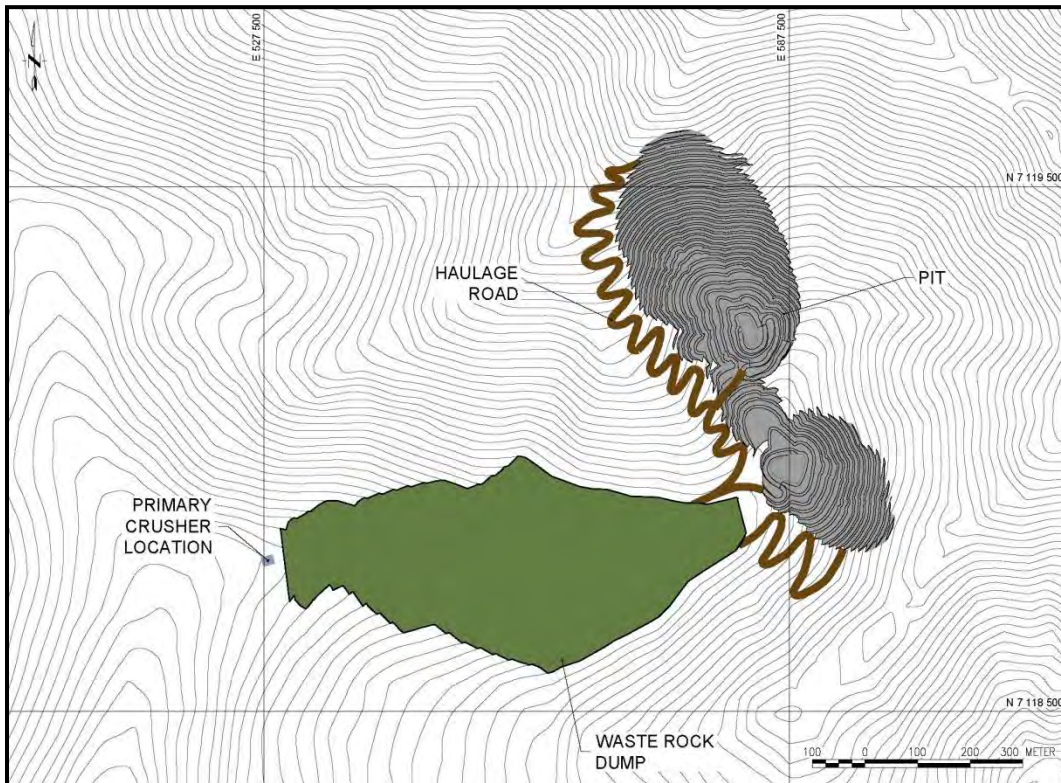

Figure 16-4
LOM Mine Status Map

16.5 Mine Waste Rock and Stockpile Management

In this study, no detailed Potentially Acid Generating / Non-Acid Generating (“PAG/NAG”) classification of the waste material was performed. All waste rock, low grade oxide material below the economic cut-off and the mineralized sulfide material will be stored in one waste dump located southwest of the pit. LOM waste material stored in the waste dump is 11.5 Mt. The waste dump is designed with an overall slope of 20°.

Low grade oxide material above the economic cut-off will be stored close to the primary crusher, at the toe of the waste dump. Stockpile material will be progressively reclaimed during the four-year production life and will be completely reclaimed by the end of the fourth production year.

16.6 Mining Equipment

16.6.1 Mine Equipment Fleet

Small mining equipment with operating flexibility was selected to match the pit production schedule and the nature of the site. The equipment selection, sizing, and fleet requirements were based on anticipated site operating conditions, haulage profiles, cycle times, and overall equipment utilization. In determining the number of units for the major equipment such as drills, excavators, and trucks, annual operating hours were calculated and compared to the available hours for the equipment. Mine support equipment, such as track dozers, motor graders, water trucks, and snow and sanding trucks, were matched with the major mining equipment. Given the short mine life, no equipment replacements were anticipated. Unless otherwise specified, all equipment will be purchased and operated by the Owner.

16.6.2 Operating Hours

Mining is assumed to operate 365 d/a, with 2 shifts per day and 12 hours per shift. As shown in Table 16-6, the expected delays per shift are 197 minutes.

**Table 16-6
Operational Delays per Shift**

Delay	Time (min)
Weather	59
Breaks	60
Shift Change	15
Blasting	30
Communication	2
Training	1
Fuel, Equipment Moves, Other	30
Total	197

16.6.3 Primary Equipment

Loading will be performed using a 6.5 m³ hydraulic excavator and hauling will be performed using 39-t articulated trucks. Haul truck cycle times were estimated using the Caterpillar Fleet Production and Cost software. Estimated travel times are provided in Table 16-7.

**Table 16-7
Haulage Cycle Times**

Production Year	Crusher/Stockpile (min)	Waste Dump (min)
-1	10.9	17.7
1	14.6	15.8
2	12.7	16.2
3	14.7	12.1
4	11.7	7.8

Blasthole drilling will be performed using 4.5" percussion crawler drills. Blasting will be performed using ammonium nitrate/fuel oil (ANFO) and emulsion with mix proportions of 0.7 and 0.3, respectively. Based on the geotechnical report (Golder, 2014), blasting will be performed only on waste rock while oxide material will be excavated directly by the hydraulic excavator.

The LOM primary equipment requirements are summarized in Table 16-8.

Table 16-8
Primary Equipment Requirements

Production Year	Diesel Drill (4.5")	Hydraulic Excavator (6.5 m³)	Articulated Trucks (39-t)
-1	1	1	3
1	1	1	5
2	1	1	5
3	1	1	4
4	1	1	2

16.6.4 Support and Ancillary Equipment

Selection of the support and ancillary equipment takes into account the size and type of the main fleet for loading and hauling, the geometry and size of the pit, and the number of roads and waste dumps that will operate at the same time. It reflects experience at operations of similar size, and also considers the specific characteristics of the Project. The LOM support and ancillary equipment requirements are listed in Table 16-9.

**Table 16-9
Support and Ancillary Equipment Requirements**

Equipment	Maximum Fleet Size
Track Dozer 9.8 ft (2.9 m)	2
Wheel Dozer 12 ft (3.6 m)	1
Grader 12 ft (3.6 m)	1
Water Truck 5000 gal (18,930 L)	1
Service Loader	1
Secondary Drill	1
Vibratory Compactor	1
Integrated Tool Carrier	1
Excavator	1
Flatbed Truck	1
Fuel/Lube Truck	1
Mechanics Service Truck	1
Welder Truck	1
Tire Service Truck	1
Snow/Sand Truck	1
Pickup Truck	4
Mobile Crane	1
Rough Terrain Forklift	1
Shop Forklift	1
Light Plant	8
Dispatch System	1
Mobile Radios	100
Safety Equipment	1
Engineering/Geology Equipment	1
Maintenance Management System	1
Surveying	1

16.7 Mining Labor

Mining labor requirements were estimated based on 12-hour shifts, 2 shifts per day, and a 2-week-on/2-week-off rotation schedule. Mine operator and maintenance staff requirements are estimated based on the scheduled hours. Salaried mine staff numbers were estimated from experience, historic data and anticipated operating conditions for the Project.

The average ratio of maintenance labor complement to operator labor complement was estimated at 0.6:1. The maintenance labor estimate is based on historical ratios between equipment operators and maintenance mechanics and electricians.

A benefit package of 40% was applied to both salaried staff and the hourly labor base rates. The labor burden consisted of vacation, statutory holidays, medical and health insurance, employment insurance, long-term disability insurance, overtime, shift differential and other factors.

Table 16-10 shows the maximum salaried staff requirements during the LOM. The hourly mining operator and maintenance labor on payroll is shown in Table 16-11.

Table 16-10
LOM Maximum Salaried Staff Requirement

Position	Maximum Number of Employees
Technical Services Staff	13
Operations Staff	4
Maintenance Staff	3
Total	20

Table 16-11
Operator and Maintenance Staff on Payroll

Production Year	Operators	Maintenance	Total
-1	36	22	58
1	56	30	86
2	57	30	87
3	53	29	82
4	22	15	37

17.0 RECOVERY METHODS

17.1 Process Design Basis

Test work results to date have indicated that the mineralized material is amenable to cyanide leaching. However due to the very high in situ clay content (approximately 45% -75 microns), very high cement additions are required for conventional agglomeration and heap leaching. Further, due to the limited extent of the deposit a full milling scenario has shown to be a marginally economic project.

This study details a hybrid processing option. ROM ore will be fed into a MMD mineral sizer, followed by a scrubber to wash and separate the clays; the fines are treated in a small CIL circuit while the clean sand and gravel-sized material is heap leached conventionally (no cement agglomeration) as a single 10 m lift on a single-use, permanent leach pad. A summary of the processing design criteria is presented in Table 17-1.

Table 17-1
Processing Design Criteria Summary

Item	Design Criteria
Annual Tonnage Processed	500,000 t/a
Average Feed Grade	Au: 3.72 g/t Ag: 5.0 g/t*
Production Rate	3,300 t/d, 158 days per year
Processing	CIL: 1,913 t/d (58% of feed) Heap Leach: 1,387 t/d (42% of feed)
Recovery of Gold	CIL: 91.0% Heap Leach: 87.8%
Recovery of Silver	CIL: 19.0% Heap leach: 19.0%
Crushing Operation	12 hours/shift, 2 shifts/day, 7 days/week, 158 days per year
Crusher Availability	75%
Heap Leaching Cycle	50 days

*Note: Silver grade was not scheduled and is assumed constant at 5.0g/t

Because of the remote location, difficult access, and moderately severe winters, the project is considered seasonal with a 158 day operating year. Most bulk reagents and supplies will be transported to the site by road during winter and stockpiled for use during the spring/summer operating season when access is only by air.

The heap leach pad is designed using a cell-based approach, where a new cell will be constructed for each year's production. The cells will be self-contained 'bathtub'-style lined basins with in-heap sumps. At the end of each year of production season cells are closed, washed and reclaimed. The tailings dam will be designed with yearly raises of the dam height, utilizing material excavated during heap leach construction.

Leach pad and tailings dam construction are the most formidable challenges facing the project. To avoid permafrost and in recognition of the short field construction seasons, the leach pad and tailings pond are excavated during the winter months. This will leave a prepared area for installation of liners for pad and tailings extensions during the summer, so that a new expansion is complete and ready for the next operating season.

The plant equipment is modular with nearly all equipment skid or trailer mounted, excepting the overland conveyors and CIL tanks. Stacking of mineralized material on the leach pad will be by a 65 m long mobile bridge stacker.

Concrete will be kept to a minimum for the processing plant by utilizing a bermed and lined containment area covered with 0.6 m of sized gravel. Small concrete pads for various tanks and footings will be poured on top of the gravel as required. All the equipment except the primary crusher will be located within this single containment area, which drains by gravity into the lined tailings dam.

The mineralized material is relatively soft and very fine. The mineralized material will be mined by standard open pit mining methods and crushed using a mineral sizer. The crushed material will be conveyed by overland conveyor to a rotary scrubber drum, where the material is washed, breaking up and separating the clay. The scrubber discharge will pass over a double-deck vibrating screen (16 mm and 9 mm decks), with the +9 mm oversize discharging onto the overland conveyor which feeds the leach pad. The undersize - 9 mm material will be fed to a screw classifier, separating +0.212 mm material to discharge onto the overland conveyor feeding the leach pad, while the -0.212 mm material overflows the launder into a 15 m diameter thickener. The thickener overflow solution is recycled back as wash water to the scrubber. The thickener underflow (40% solids) is sent to a five-tank CIL circuit with 24 hr retention time. The slurry from the CIL tanks passes through a cyanide destruction circuit before finally discharging into the tailings dam. Hydrogen peroxide will be used to destroy the cyanide.

The loaded carbon from the CIL will be stripped using a modified Zadra pressure-strip circuit in three tonne batches. The pressure-strip includes an acid wash circuit and small

carbon regeneration circuit. This stripping circuit will also accommodate the loaded carbon from the heap leach.

All of the +0.212 mm oversize material reports to the leach pad via an overland conveyor and a mobile bridge stacker. The bridge stacker discharges down, forming a single lift (10 m high) within a closed leach pad while advancing forward on top of newly stacked material. Sprinklers or driptubes are used to irrigate the mineralized material with a 50 day leach cycle. Pregnant solution will be pumped through a series of five pressurized carbon columns which discharges barren solution to a barren solution tank. Make-up cyanide is added to the barren solution tank before being pumped through the sprinklers onto the fresh mineralized material. Carbon from the heap leach will be processed in the shared stripping plant, where the carbon is stripped, acid washed, and regenerated.

After being stripped from carbon, the gold will be plated on stainless steel-wool cathodes by electrowinning. The gold sludge will be washed from the steel wool, filtered, retorted to remove mercury, and then smelted to produce Doré bullion.

As a seasonal project, each year's rinsed and finished leach pad will be covered with a High Density Polyethylene ("HDPE") liner and permanently sealed shut. Construction activities will be organized such that each spring a new leach pad and lined tailings pad will be ready from construction during the previous year (with the exception of Year -1, in which no production is planned).

Generators will be used to supply electric power to all elements of the process plant and a stand-by back-up generator is provided. A prefabricated insulated fabric building will enclose the main plant (crusher, leach pads, CIL tanks, and tailings impoundment excluded).

Bulk reagents of significant quantity, namely hydrated lime and sodium cyanide, will be transported during winter months by road. Reagents will be stored in waterproof super-sacks and containers (on lined containment areas that free drain to the leach pad or tailings dam) to be used in the following operating season. It is estimated that approximately 120 sea-containers of lime and 15 of sodium cyanide will be needed each year (all 40-foot long sea-containers).

Preliminary results from permeability tests and column leach tests show that agglomeration of oversize material using cement will not be required. Lime will be added at an average rate of 4.75 kg/t mineralized material for pH control. The lime will be added by screw feeder to the conveyor feeding the scrubber.

The simplified Tiger process flowsheet is presented in Figure 17-1. The site general layout is presented in Figure 17-2. All the selected processes and equipment are established technologies used in gold processing plants. A plant layout is presented in Figure 17-3.

The heap leach pad and tailings locations have been selected as an optimal compromise between proximity to the open pit mines and suitable ground conditions (can be excavated to solid bedrock and not affected by permafrost or other potential stability issues related to arctic conditions).

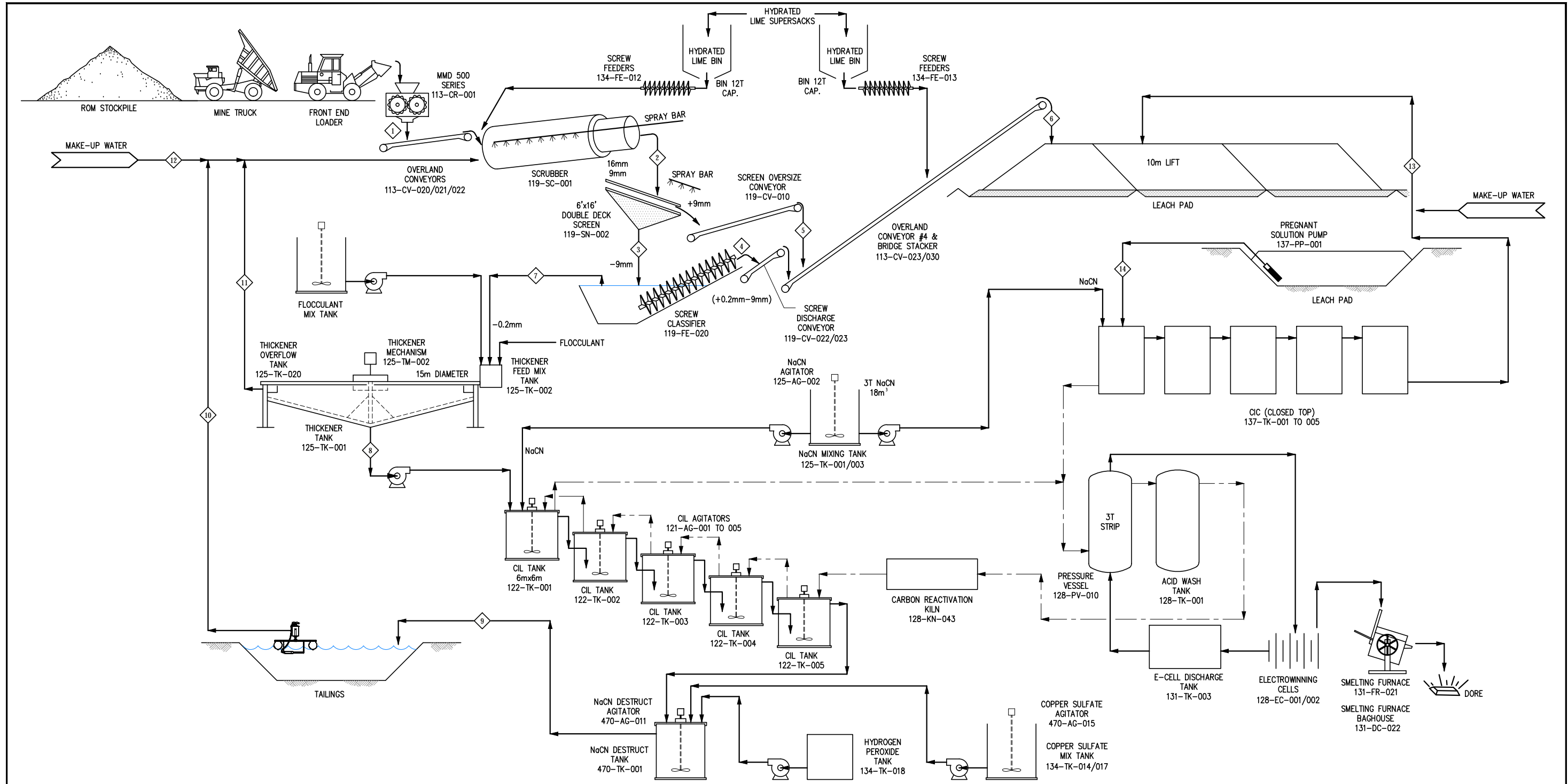

STREAM NO.	1	2	3	4	5	6	7	8	9	10	11	12	13	14
SOLIDS, t/h	137.5	138.0	128.0	48.0	9.6	57.8	80.0	80.0	80.0	0	0	0	0	0
SOLUTION, t/h	15.3	485.0	464.0	9.0	1.0	10.1	455.0	120.0	120.0	86.0	355.0	29.0	50.0	50.0
SOLIDS, %	0.9	23.0	22.0	84.0	91.0	82.0	15.0	40.0	40.0	0	0	0	0	0
DENSITY														

**Figure 17-1
Simplified Process Flowsheet**

COPYRIGHT retained by Kappes, Cassidy & Associates. This drawing NOT to be used or reproduced without permission.

REFERENCE DRAWINGS		REVISIONS					REVISIONS					DESIGNED BY: TOS	DRAWN BY: MCC	CHECKED BY:	APPROVED 1	APPROVED 2	CLIENT APPL		Project: TIGER GOLD PROJECT		
DWG. NO.	TITLE	NO.	BY	CK'D	APPROVED	DATE	DESCRIPTION	NO.	BY	CK'D	APPROVED								DATE	DESCRIPTION	Job No.
																			FLOWSHEET PROCESS PLANT SIMPLIFIED FLOWSHEET		
																		Job No. 691 G Scale NONE ACAD Filename: 8740-0110-11-100.dwg	8740 0110-11-100		
																		REV Dx			

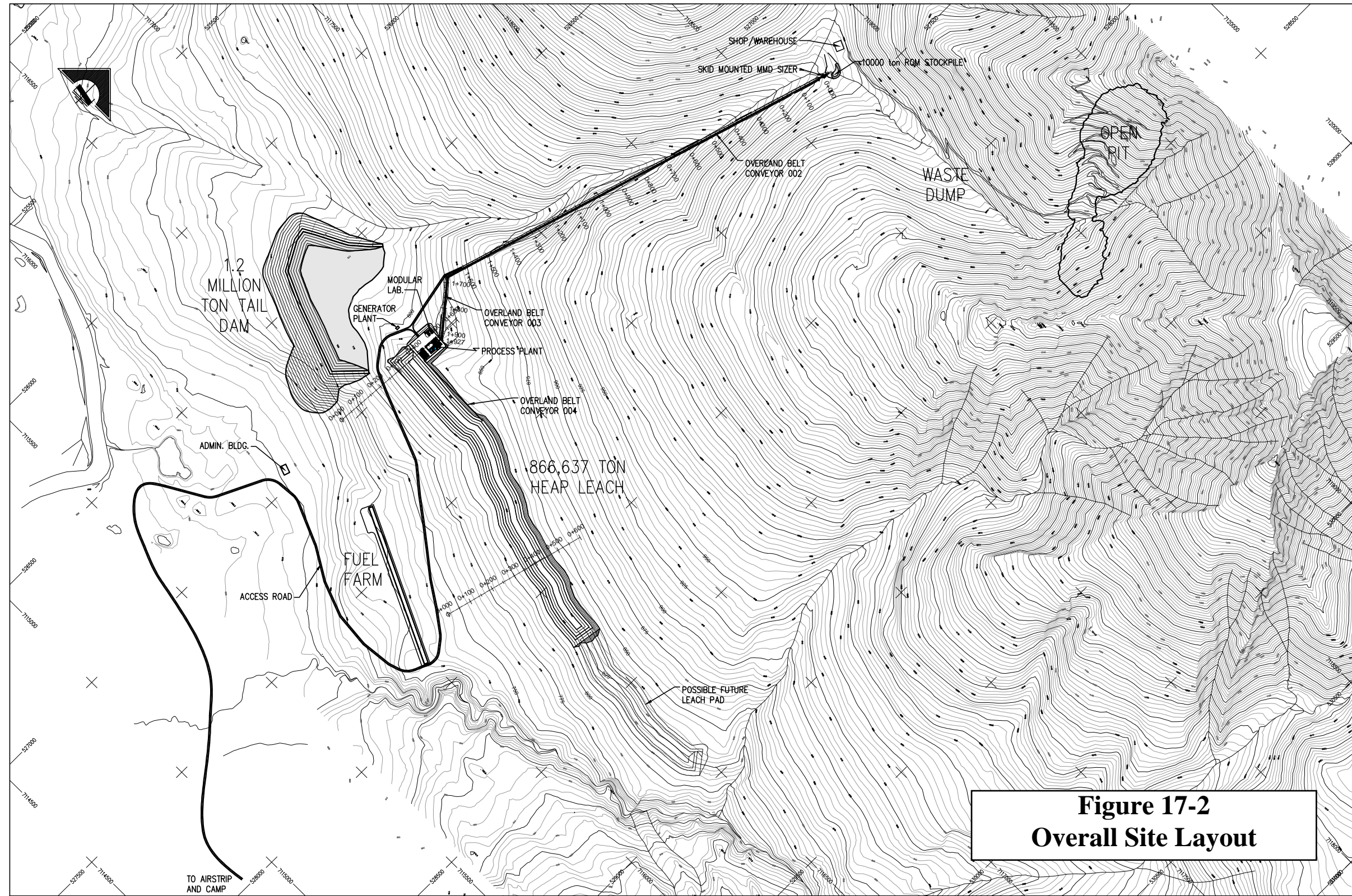

**Figure 17-2
Overall Site Layout**

PRELIMINARY
NOT FOR CONSTRUCTION

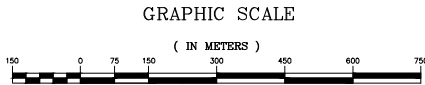

1 : 7500
CONTOUR INTERVAL = 5 meters

OVERALL LAYOUT

COPYRIGHT retained by Kappes, Cassidy & Associates. This drawing NOT to be used or reproduced without permission.

REFERENCE DRAWINGS		REVISIONS					REVISIONS					DESIGNED BY:		Project:		
DWG. NO.	TITLE	NO.	BY	CK'D	APPROVED	DATE	DESCRIPTION	NO.	BY	CK'D	APPROVED	DATE	DESCRIPTION	RLF/PRV	Drawn By	TIGER GOLD PROJECT
		1	PRV	RLF		22 AUG '13	ISSUED FOR INFORMATION	1	PRV	RLF				PRV		Title: PROCESS PLANT OVERALL SITE LAYOUT GENERAL ARRANGEMENT PLAN VIEW
		2	EDZ	TDS		09 JUN '14	ISSUED FOR INFORMATION	2	EDZ	TDS				CHECKED BY		
		3	AAH	TDS		23 JUN 14	LEACH PAD MODIFIED, PROCESS PLANT ADJ.	3	AAH	TDS				APPROVED 1		Job No. 718 H
														APPROVED 2	Scale 1:7500	ACAD Filename: 8740-0110-13-100
														CLIENT APPL	8740	0110-13-100
															REV C	

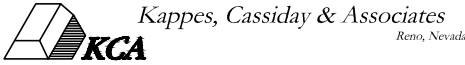

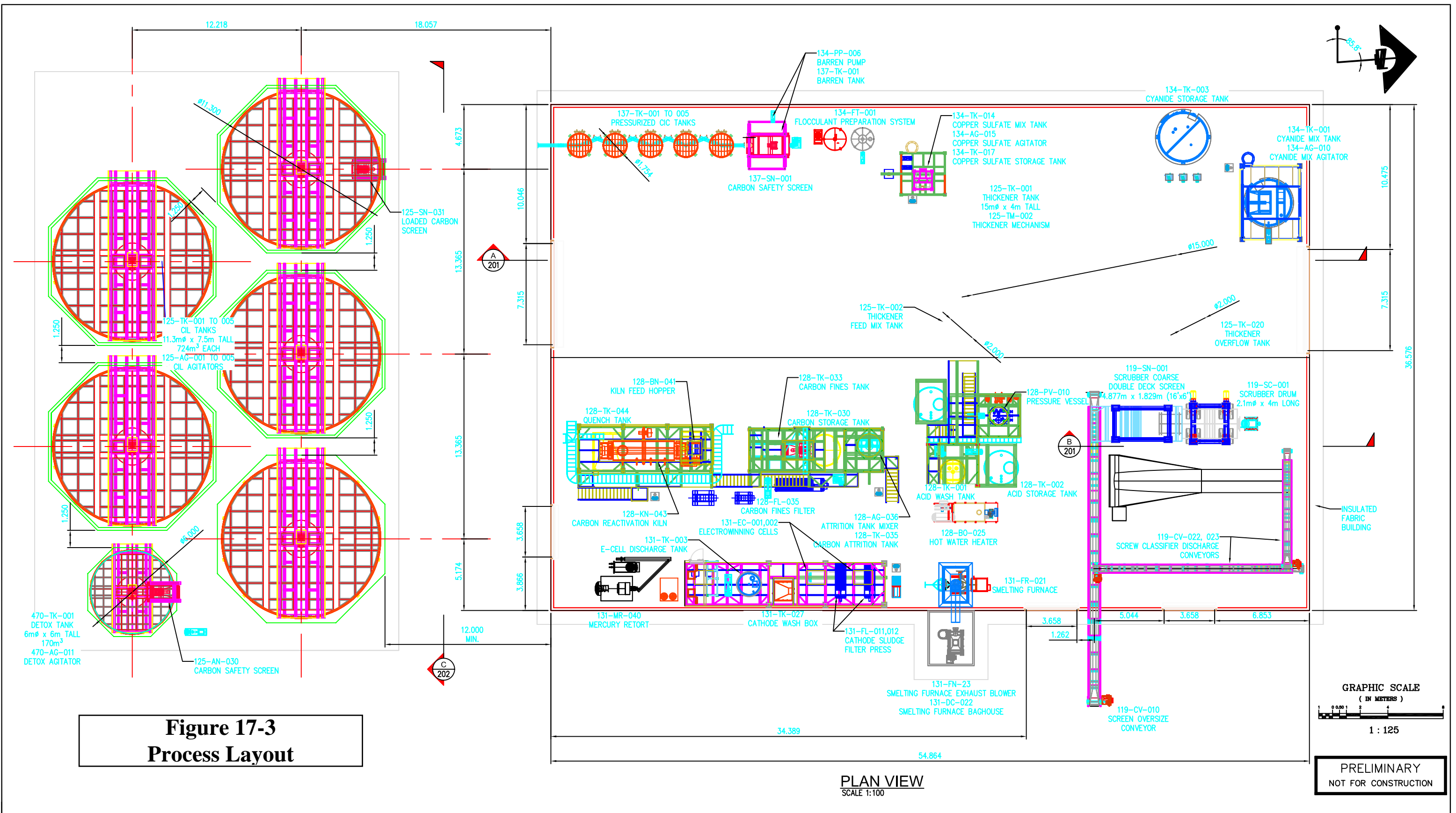

**Figure 17-3
Process Layout**

**PRELIMINARY
NOT FOR CONSTRUCTION**

REFERENCE DRAWINGS	
DWG. NO.	TITLE
8740-0110-13-201	PROCESS PLANT_GA_EQUIPMENT LAYOUT_SECTIONS (1 of 2)
8740-0110-13-202	PROCESS PLANT_GA_EQUIPMENT LAYOUT_SECTIONS (2 of 2)

REVISIONS					
NO.	BY	CK'D	APPROVED	DATE	DESCRIPTION

REVISIONS					
NO.	BY	CK'D	APPROVED	DATE	DESCRIPTION
1	AAH	TDS		23APR14	ISSUED FOR REVIEW
2	AAH	TDS		23JUN14	CHANGED OIL TANK SIZE; MOVED TANKS OUTSIDE OF BUILDING
3	EDZ	TDS		30JUN14	ADDED PUMP AT CIC AREA

DESIGNED BY KCA	PREPARED FOR Resources Ltd.
DRAWN BY KCA	PREPARED BY Kappes, Cassidy & Associates Reno, Nevada
CHECKED BY	
APPROVED 1	
APPROVED 2	
CLIENT APPL	

Project: TIGER ATAC	
Title: PROCESS PLANT GENERAL ARRANGEMENT PROCESS PLANT EQUIPMENT LAYOUT PLAN VIEW	
Job No. 691 G	Scale AS SHOWN
ACAD Filename: 8740-0110-13-200	REV C
8740	0110-13-200

NAME: \\DRAWINGS\Active Projects\Tiger ATAC\Tiger Hybrid PEA Drawing\DWG Working\13-General Arrangement\8740-0110-13-200.dwg LAST UPDATE: 30-Jun-14, 3:40 PM PLOT DATE: 4-Aug-14 BY: ED PLOT SCALE: 1:2.5849

COPYRIGHT retained by Kappes, Cassidy & Associates. This drawing NOT to be used or reproduced without permission.

17.1.1 Processing Rate Ramp-up

By necessity, a full year of pre-production construction is provided to allow for earthworks, compaction, and liner installation in the leach pad and tailings impoundments prior to the first year of production. This allows for a complete season of full production during year one of operation. This will also allow liner installation to proceed such that all of the lined areas required in year two are completed during year one, and again in the same manner for each subsequent year.

17.2 Crushing

ROM mineralized material will be transported from the mine in 39-ton surface haul trucks to the primary crusher area and stockpiled. All mineralized material will be fed by a Cat 966 loader to an MMD mineral sizer.

Mineralized material will be fed from the stockpile to the sizer at an average rate of 137.5 t/h. The crushed material will be conveyed 2.8 km by a series of two overland conveyors to the main processing plant, located adjacent to the leach pad and tailings dam.

17.3 Scrubbing, Screening, Classification

The overland conveyors will discharge into a rotating scrubber drum where water is added. The wet slurried material will discharge onto a 1.8 m x 4.9 m double deck screen (16 mm and 9 mm apertures, top and bottom decks respectively), making a material cut of 9 mm. The oversize is routed directly to the leach pad stacking system via conveyors. The undersize slurry discharges directly below the screen into a screw classifier.

The screw classifier separates the screen underflow slurry at a 0.212 mm cut, dewatering the sandy material as it advances upward and discharging onto the same conveyor carrying the screen oversize to the leach pad stacking system. The undersize slurry, containing the clay material, overflows the screw classifier launder and is directed to a 15 m diameter thickener. The thickener overflow solution is recycled directly back to the scrubber.

17.4 CIL Circuit

The thickened slurry (40% solids) is pumped to a standard CIL circuit, where carbon is maintained at a density of 18 g/L of slurry in a series of five agitated reactor tanks. Slurry overflows from one tank to the next by gravity, providing an overall leach retention time of 24 hours.

Loaded carbon will be screened from the slurry in the lead tank and sent to the carbon stripping circuit for elution and metals removal in 3 t batches approximately four times each week. The downstream carbon is then advanced to the next tank upstream in counter-current fashion.

Discharge slurry from the CIL tanks is pumped to the cyanide destruction circuit, and finally pumped to the tailings impoundment.

17.5 Tailings Impoundment

The tailings impoundment uses a downstream construction method with engineered structural fill used to form the dike. Dike construction will be phased, with annual raises used to provide needed capacity for each following year. Fill material for each yearly dike-raise will be sourced from cut material originating from the corresponding heap leach cell excavation.

The impoundment will be lined with a single 1.5 mm HDPE liner on top of a geosynthetic clay liner (“GCL”).

The tailings dam at ultimate design crest is shown in Figure 17-4.

The tailings impoundment also serves as the event pond for the heap leach.

A reclaim water pump will be installed on a float in the water pool inside the tailings impoundment. Reclaim water will be pumped from the impoundment to the process water head tank and re-used in the process circuits.

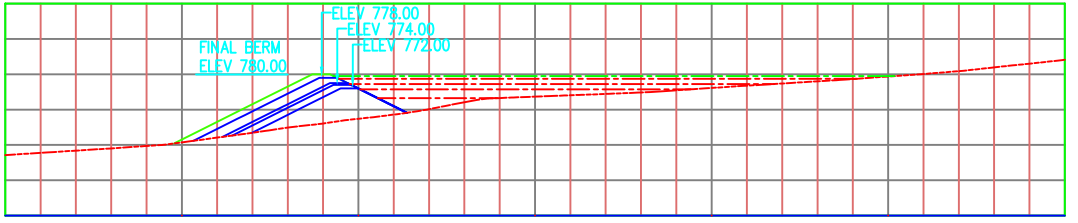
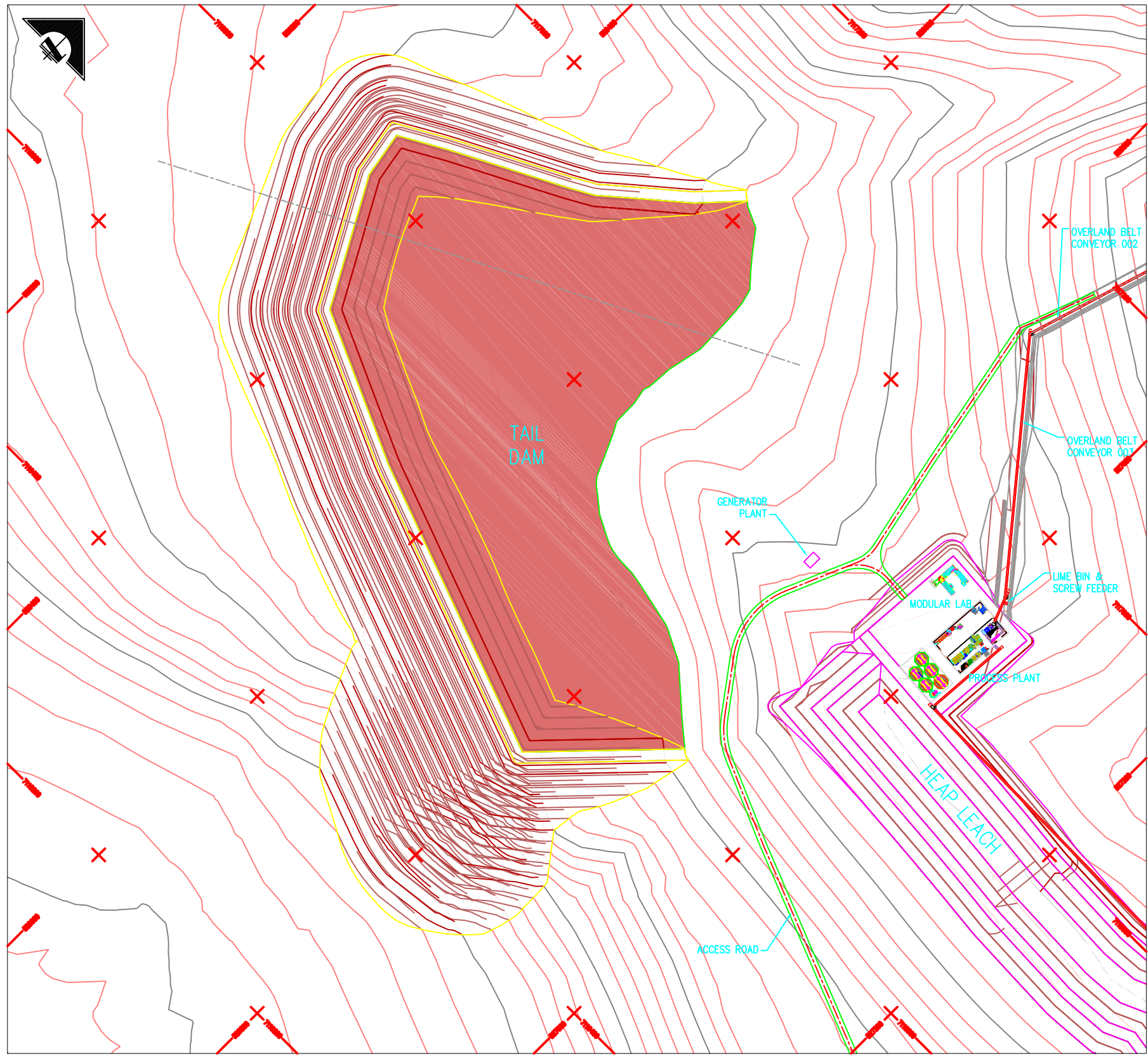

**Figure 17-4
Tailings Dam Layout - Ultimate Crest**

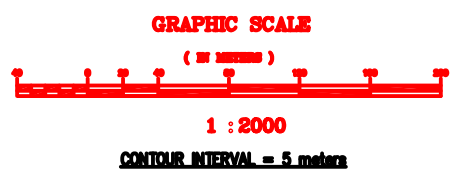

PRELIMINARY
NOT FOR CONSTRUCTION

TAILING DAM ULTIMATE, INCLUDED FREEBOARD
REQ'D=1,196,000 ton CAPACITY=1,296,000 ton

COPYRIGHT retained by Kappes, Cassidy & Associates. This drawing NOT to be used or reproduced without permission.

REFERENCE DRAWINGS		REVISIONS					REVISIONS					DESIGNED BY:		
DWG. NO.	TITLE	NO.	BY	CK'D	APPROVED	DATE	DESCRIPTION	NO.	BY	CK'D	APPROVED	DATE	DESCRIPTION	DESIGNED BY:
		▲	PRV	RLP		22 AUG '13	ISSUED FOR INFORMATION	▲	PRV	RLP				DESIGNED BY:
		▲	EDZ	TRB		09 JUN '14	ISSUED FOR INFORMATION	▲	EDZ	TRB				DRAWN BY:
		▲	AMH	TRB		23 APR '14	TAILING DAM MODIFIED, PROCESS PLANT ADJ.	▲	AMH	TRB				CHECKED BY:
		▲						▲						APPROVED 1
		▲						▲						APPROVED 2
		▲						▲						CLIENT APPL



Project: TIGER GOLD PROJECT		
Title: PROCESS PLANT TAILING DAM ULTIMATE LAYOUT GENERAL ARRANGEMENT PLAN VIEW		
Job No. 8740	Scale 1:2000	ACAD Filename: 8740-0110-13-110
		REV c

NAME: J:\DRAWINGS\Active Projects\Tiger ATAC\Tiger Hybrid PEA Drawing\DWG Working\15-General Arrangement\0740-0110-13-110.dwg LAST UPDATE: 30-Jun-14, 3:21 PM PLOT DATE: 4-Aug-14 BY: ED PLOT SCALE: 1:2500

17.6 Heap Leach Facility

17.6.1 Conveying and Stacking

The heap will be constructed in a single 10 m high lift, using a mobile conveyor bridge-stacking system. The system will consist of an overland conveyor (with moveable tripper car) and a track mounted bridge stacker with a moveable discharge. As the stacked mineralized material advances evenly from end to end, the bridge stacker will be advanced forward a few meters, with the tracks driving on top of the freshly stacked mineralized material. This process will be repeated continuously, and the stacking face will advance approximately 1-2 m per day.

The stacked material will be a mixture of freshly screened oversize and washed and dewatered screw classifier discharge largely free of clays. Preliminary tests show this material (sandy fine gravel) to be very permeable and rapidly free-draining. There is the possibility of the material having a tendency to “sand-castle”, in that it will not always ravel easily down slope as it is being stacked. This may require occasional smoothing with a small dozer prior to the irrigation cycle.

17.6.2 Leach Pad

The preliminary design of the Heap Leach Facility (“HLF”) meets or exceeds U.S. standards and practices for containment, which is intended to lessen the environmental risk of the facilities to impact the local soils, surface water, and ground water in and around the site.

The HLF is intended to operate as a zero discharge system; therefore, the design includes provisions to accommodate upset conditions such as severe storms and temporary loss of electric power or pumps.

The HLF will have the following features:

- Constructed in discreet phases corresponding with each operating season’s annual production.
- Full-sided ‘bathtub’ style of impoundment, with an internal sump for collection of pregnant solution.

- A composite base liner that meets or exceeds international standards consisting of (from the base up): GCL (a manufactured bentonite-geotextile ‘sandwich’ system); 1.5 mm HDPE geomembrane; geonet serving as a between-liner leak detection / recapture layer; another 1.5 mm HDPE liner.
- Mineralized material will be stacked in a single 10 m lift using a bridge stacker.
- During operation, pregnant solution will be pumped from the pregnant solution sump inside the leach pad, at the low end, to an adsorption facility. The irrigation system is designed for a 50 day leach cycle at a flowrate of 50 m³/h.
- Each phase of the heap will be sealed and reclaimed in the season following its use.

17.6.3 Heap Leaching Systems

A total leach cycle of 50 days has been selected for the heap leach system, which is based upon preliminary metallurgical test work with appropriate field adjustments made, as described in Section 13. Leach solution will be applied to the mineralized material at a nominal application rate of 10 L/h/m² with a maximum cyanide concentration of 250 ppm to the heap.

A pump mounted beside the barren tank will be used for barren solution application to the heap. High-strength cyanide and an antiscalant agent will be added to the suction side of the barren leach solution pumps by metering pumps. The nominal flow rate of barren solution is 50 m³/h with a concentration of 250 ppm cyanide.

A 150 mm header pipe from the barren tank pump will supply the solution to the active irrigation areas on the leach pad. Valved tees at the header will supply leach solution to re-usable 50 mm sprinkler pipes that distribute solution to the top of the stacked mineralized material. Either sprinklers or drip emitters will be used depending upon evaporation requirements.

Gold bearing solutions draining from the leach pad will be collected at the bottom of the mineralized material stack by a network of perforated drainage pipes and directed to the pregnant sump.

Submersible pumps in the internal sumps will be used for pregnant solution extraction.

17.6.4 Solution Collection Systems

During leaching of the mineralized material, solution will be collected above the composite liner system within the drainage area and directed down gradient into an in-heap sump.

A submersible pump will collect the pregnant solution from the sump and pump it to the closed vessel carbon columns.

17.7 Solution Management

The Tiger Gold Project processing plant is designed as a zero discharge facility. Pregnant solution will be collected in a sump in the leach pad, pumped through a series of closed-top carbon columns and the resulting barren solution transferred to a solution storage tank. Make-up water for the heap will be added at the barren solution tank before being returned to the heap.

Based on average precipitation data for the Project site, the heap and tailings dam have adequate capacity for all solution accumulation, primarily from the winter months in which the processing plant will not be in active operation. Any solution accumulated over the winter is expected to be used during the first month or two of operation in the following summer. During normal operations water will be sourced for the process from the thickener overflows and tailings decant first before drawing fresh make-up water. Peak make-up water demand during operation is expected to be 16 m³/h.

In order to prevent accumulation of process solution and to conduct progressive reclamation, inactive areas of the leach pad will be capped and sealed each year with a plastic HDPE liner.

17.8 Recovery Plant

The recovery plant is designed to recover gold by an adsorption-desorption-recovery (“ADR”) process. Precious metals in the heap leach pregnant solution will be adsorbed on to activated carbon (adsorption) in a series of columns. Precious metals in the CIL circuit will be loaded onto activated carbon in the tanks. Loaded carbon from the heap leach and CIL circuit will be desorbed in a high-temperature elution process coupled to

an electrowinning circuit (desorption), followed by retorting and smelting of the resulting sludge to produce Doré bullion (recovery).

A single desorption circuit will serve to process carbon from both the heap leach and CIL circuits.

Heap leach pregnant solution will be pumped directly to an adsorption circuit (5 closed-top carbon columns) using a submersible pump located in the currently active pregnant solution sump. Antiscalant will be added to the pump suction to prevent scaling of the piping systems, carbon, and to reduce the impact of scale on the carbon gold adsorption capability.

In the heap adsorption circuit the pregnant solution will pass through a train of five closed-top carbon columns, where the gold will be adsorbed onto activated carbon. The column train will have a nominal solution capacity of 50 m³/h. Each column is oversized (due to required metal loading capacity) to contain 3 tonnes of carbon. The columns will be operated in a “packed bed” flow regime, requiring occasional higher flow rates to fluidize the carbon bed. This will be done 1-2 times per day for periods of a few minutes. The barren solution discharging from the final column will flow through a stationary carbon safety screen at the inlet to the discharge launder to remove any floating carbon before flowing by gravity to the barren tank, where the solution will be recharged with cyanide and make-up water added prior to being pumped back to the leach pad irrigation system.

Carbon will advance through the columns counter current to the solution flow, with freshly stripped or regenerated carbon placed in the last cell. Carbon transfer will be accomplished by eductors.

Loaded carbon from the CIL circuit will be advanced from the lead CIL tank, screened and rinsed prior to advancement to the acid wash circuit. Carbon transfer from the CIL will be by recessed impeller pump in 3 tonne batches each day.

Generally the stripping sequence will be to strip carbon from the CIL each day for two consecutive days and every third day for the heap leach.

Prior to elution, each batch of carbon (from the CIL or heap leach) will be advanced to the acid wash vessel to remove any scale and other inorganic contaminants that might inhibit gold adsorption onto carbon. The acid wash circuit will have capacity to process a 3 tonne batch of carbon. During this process the carbon will be washed with a dilute

hydrochloric acid solution (approximately 3% HCl by weight). After acid washing, the loaded carbon will be pumped to the elution column.

The elution column is designed to process up to 3 tonnes of carbon in a modified Zadra-type desorption cycle, typically requiring 12-16 hours per cycle. During this process, the gold will be removed from the carbon with a hot caustic strip solution at a temperature of 135°C and a pressure of 350-480 kPa (50-70 psi). The solution will be heated indirectly using a diesel-fired boiler and heat exchangers. The strip solution exiting the elution column will be cooled through a heat exchanger and flow to an electrowinning cell (“E-Cell”) installed in series with the column. In the E-Cell, gold will be continuously electrowon onto stainless steel wool cathodes during the desorption cycle.

Periodically, the stainless steel cathodes will be washed with a high pressure spray to remove the gold. The resulting sludge will be manually decanted and dried in a mercury retort to remove any contained mercury. After retorting, the gold sludge will be mixed with fluxes and smelted in a diesel-fired furnace to produce Doré bullion. The bullion will be shipped offsite by air for further refining and sales. The mercury recovered in the retort will be collected in a water trap collector, periodically drained from the trap and collected in air tight vessels. Mercury will be shipped offsite for disposal.

After every third stripping cycle (on average), eluted carbon will be transferred to a kiln where the carbon will be processed at approximately 750°C to regenerate its adsorption capacity. The kiln will have the capacity to regenerate carbon at a rate of 125 kg/h. In the case where carbon is not to be regenerated after a strip cycle, it will be returned to the last column of the heap adsorption circuit or the last tank of the CIL circuit.

17.9 Process Reagents and Consumables

17.9.1 Lime Addition

Hydrated lime will be transported during winter months by road and stored in waterproof super-sacks and containers (on lined containment areas that free drain to the leach pad or tailings dam) to be used in the following operating season. It is estimated that approximately 120 each 40-foot sea-containers of lime per year will be required.

A bag-cutting and loading bin with a capacity of 15 tonnes will supply a screw feeder which will feed lime onto the conveyor feeding the scrubber drum with a second screw

feeder to add hydrated lime to the heap circuit as required. The screw feeder will be adjustable and it is likely that the heap leach will require a smaller proportion of the total lime addition of 4.75 kg/t.

17.9.2 Cyanide Addition

A cyanide mixing area, consisting of an agitated mixing tank and a day tank with a capacity for mixing and storing 3 tonnes of sodium cyanide, will be used to supply and meter cyanide to each of the circuits. This will allow for mixing a full batch every other day. The cyanide will be added at the barren tank of the heap leach circuit and into the first tank of the CIL circuit.

Average estimated annual reagent and consumable consumptions for the process are shown in 17-2.

Table 17-2
Projected Annual Reagents and Consumables

Item	Form	Annual Usage	40', 20 t Containers
Sodium Cyanide	Briquettes – 1 t Super-sacks	367 t	15
Lime (Hydrated)	1 t Super-sacks	2375 t	120
Activated Carbon	500 kg Super-sacks	21 t	1
Antiscalant	Liquid Tote 1 m ³ Bins	1.440 L	N/A
Sodium Hydroxide	Dry Solid Sacks	5.3 t	N/A
Hydrochloric Acid	Liquid Tote 1 m ³ Bins	79 m ³	N/A
Hydrogen Peroxide	Liquid Tote 1 m ³ Bins	63 t	N/A
Fluxes	Dry Solid Sacks	5.5 t	N/A

17.10 Cyanide Destruction

The CIL discharge slurry will be pumped to an agitated reactor tank where hydrogen peroxide and a small amount of copper sulfate (catalyst) are added. The hydrogen peroxide will be delivered in one tonne tote bins. Expected usage is less than half of one tote bin per day.

17.11 Process Water Balance

KCA prepared a water balance using Excel spreadsheets. The model approximates the circulation of solutions within the heap leach and process facility, as well as the introduction of precipitation and evaporation as a function of time. The results of the water balance model predict make-up water flow rates and minimum storage capacities necessary in order to achieve a zero-discharge system.

The model uses time steps of months, which provides monthly average flow rates and volumes, as opposed to peak daily or peak instantaneous rates. This approach may attenuate the peak rate, as it averages the volumes over a monthly period.

The water balance for an average precipitation year for the Tiger Gold Project is presented in Table 17-3.

**Table 17-3
Average Precipitation Water Balance – Tiger Gold Project**

Tiger Gold Project Full Pad Water Balance Model Average Rainfall - Sprinklers														
Tails Ultimate Density	75.0%											enhanced evap	%	
Tails Dam Size (m2)	39,600											retained moisture	8.20%	
Lined Pad/Ditch Collection Area (sq. m)	66,539											moisture wet season		
Tails Pond Area (%)	10% estimated at right											moisture Summer	10.0%	
Total Leach Flow to Heap (m ³ /hr)	50.0											Operate		
Wet Season Ore Absorption (%)												Closed for Winter		
Net Ore Absorption (%)	(1.80)											Sprinkler Evap	3.00	
Allowable Wet Season Accumulation in Ponds (m ³)	0											application rate	10 l/h/m2 16 m3/h/m2	
								13	31	30	31	31		
		Oct	Nov	Dec	Jan	Feb	Mar	Apr	May	Jun	Jul	Aug	Sep	Annual
Precipitation (mm)		31.4	25.5	22.0	19.4	12.8	9.9	8.2	30.8	38.2	49.0	43.4	34.0	324.6
Pan Evapotranspiration (mm)		45.0	36.6	31.5	27.8	18.3	14.2	11.8	44.2	54.8	70.2	62.2	48.7	465.3
Enhanced Evaporation (%)		-	-	-	-	-	-	-	-	-	-	-	-	0.0
Sprinkler Evap. (%)								0.9	3.4	4.2	5.4	4.8	3.8	3.0
Idle Heap Evapotranspiration Area, 75% of Calc Area (m ²)								49,901	49,901	49,901	49,901	49,901	49,901	
Idle Heap Evapotranspiration (mm)								8.2	30.9	38.3	49.2	43.6	34.1	204.3
Ore Placed on Pad (tonnes)								18,031	42,997	41,610	42,997	42,997	22,192	210,824
Ore Fed to Leach (tonnes)								24,869	59,303	57,390	59,303	59,303	30,608	290,776
Precipitation. Collected (m ³)		1,243	1,010	871	768	507	392	870	3,269	4,055	5,201	4,606	3,609	26,402
Moisture in Ore		0	0	0	0	0	0	4,767	11,367	11,000	11,367	11,367	5,867	55,733
Ore Absorption (m ³)		0	0	0	0	0	0	1,611	3,841	3,717	3,841	3,841	1,982	18,832
Sprinkler Evaporation (m ³)		0	0	0	0	0	0	142	1,271	1,525	2,022	1,791	724	7,474
Evapotranspiration (m ³)		0	0	0	0	0	0	409	1,537	1,906	2,445	2,166	1,697	10,160
Dam Evaporation (m ³)		178	145	125	110	73	56	47	175	217	278	246	193	1,843
Water Trapped in Dam (m ³)		0	0	0	0	0	0	8,290	19,768	19,130	19,768	19,768	10,203	96,925
Net Precipitation. Gain(+)/Loss(-) in HL (m ³)		1,065	865	746	658	434	336	(4,861)	(11,955)	(11,441)	(11,786)	(11,838)	(5,323)	(53,099)
Tails Dam Solution Pond(s)														
Allowable Accumulation in Tails (m ³)		0	0	0	0	0	0	0	0	0	0	0	0	
Accumulated into Tails (m ³)		1,065	865	746	658	434	336	(4,861)	(11,955)	(11,441)	(11,786)	(11,838)	(5,323)	(53,099)
Discharge from Tails (m ³)														0
Quantity in Tails (m ³)	0	1,065	1,930	2,677	3,335	3,769	4,105	0	0	0	0	0	0	
Makeup Solution Required (m ³)		0	0	0	0	0	0	756	11,955	11,441	11,786	11,838	5,323	53,099
Solution to Treat/Discharge (m ³)		0	0	0	0	0	0	0	0	0	0	0	0	0
Equiv. m3/hr to discharge (m ³)		0	0	0	0	0	0	0	0	0	0	0	0	0
		Oct	Nov	Dec	Jan	Feb	Mar	Apr	May	Jun	Jul	Aug	Sep	Annual
Precipitation (mm)		31	26	22	19	13	10	8	31	38	49	43	34	325
Make-up Water, m ³ / hr		0	0	0	0	0	0	2	16	16	16	16	14	14.6
Event Pond(s) to HLF, m ³ / hr		0	0	0	0	0	0	0	0	0	0	0	0	
Empty Event Pond(s) in One Month, m ³ / hr		1	3	4	5	5	6	0	0	0	0	0	0	

17.11.1 Make-up Water Results

Based on the water balance, for an average precipitation year the Tiger Gold Project is expected to operate in a water deficit. A total of 53,099 m³ of make-up solution will be required during the operating months. Any solution accumulated in the tailings pond (primarily during the winter months when processing is suspended) is returned to the plant as soon as possible as make-up solution. Peak water demand is 16 m³/h during operating months.

17.12 Process Power Requirement

Power usage for process plant and infrastructure was derived from estimated connected loads assigned to powered equipment from the mechanical equipment list. Equipment power demands under normal operation were assigned and coupled with estimated on-stream times to determine the average energy usage.

KCA's scope for power estimation includes the heap leach, CIL, conveyors, recovery plant, and infrastructure such as the laboratory, administration building, camp, and refinery. Based on this estimate the total attached power is 2.0 MW. The average power demand for the Tiger Gold Project is estimated to be 1.2 MW. The mineral sizer will be powered with an included diesel generator.

18.0 PROJECT INFRASTRUCTURE

18.1 Access & Facilities

18.1.1 Existing Infrastructure

Existing infrastructure at the Tiger Gold Project consists of an exploration tent-camp located near the proposed mine site, and a 900 m air-strip, which lies 8.2 km from the proposed plant site.

The camp has 24 tent platforms for four-man canvas tents, a wooden kitchen building, and a wooden warehouse building. Currently capacity is limited to 50 persons by regulation as the site lacks a septic system (only out-houses are used). With the addition of a septic system, the camp could quickly accommodate 100 persons while the permanent camp is constructed and support other early construction activities.

There is also a wooden core shack and other core-storage facilities, two helicopter landing areas, and a small bermed fuel cache.

There are currently some 9 km of ATV trails between the camp and the Tiger Deposit.

Communications are by temporary satellite dishes installed temporarily during exploration field seasons.

The existing exploration facilities can serve as a base to initiate construction; however the current infrastructure will be insufficient to accommodate the full construction requirements.

18.1.2 Roads and Bridges

Existing road access, via the Yukon highway system and publicly maintained roads, currently extends to Hansen Lakes, at which point a new winter road will be built to provide seasonal access to the project. This road will only be accessible during the winter as it requires an ice crossing of the Beaver River. The access road will utilize portions of the existing Wind River Trail that may require improvements including widening and crowning to improve road safety for transportation of heavy loads during construction and regular operations traffic after mine start-up. The total length of the new road is 51.6

km, plus 24.6 km of upgrade to the existing Wind River Trail. An additional 8.2 km of all-season road will provide access from the camp / air-strip area to the plant site.

Project Access Roads are shown in Figure 18-1.

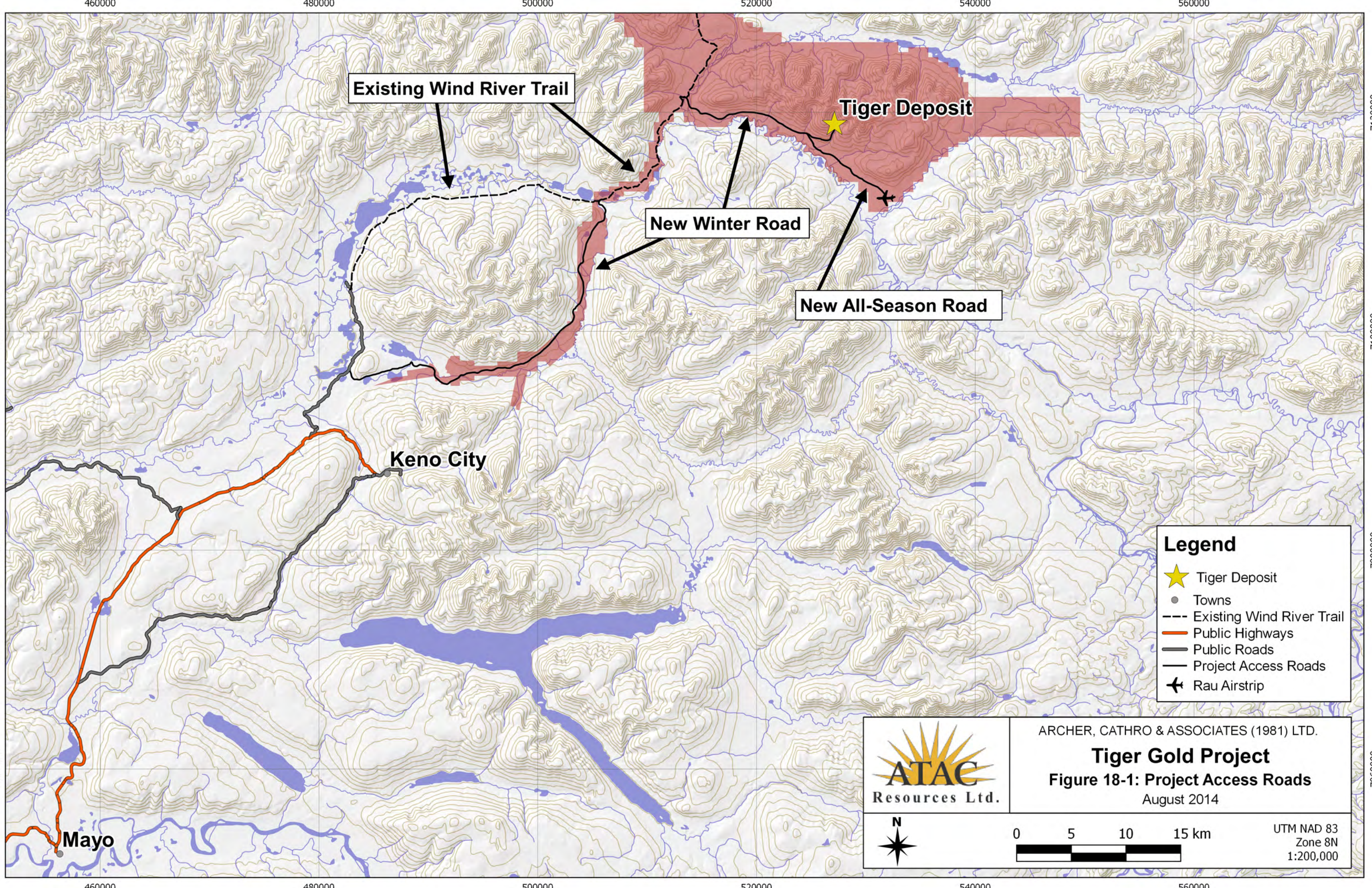

Existing Wind River Trail

Tiger Deposit

New Winter Road

New All-Season Road

Keno City

Mayo

Legend

-  Tiger Deposit
-  Towns
-  Existing Wind River Trail
-  Public Highways
-  Public Roads
-  Project Access Roads
-  Rau Airstrip



ARCHER, CATHRO & ASSOCIATES (1981) LTD.

Tiger Gold Project

Figure 18-1: Project Access Roads

August 2014

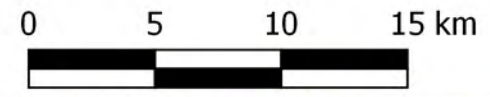

UTM NAD 83
Zone 8N
1:200,000

18.1.3 Mine Haulage Roads

The main mine haul road is 15 m wide in areas of two-way traffic, 8 m wide in areas of one-way traffic and is approximately 2.5 km in length. This road has been designed to service the pit, crusher and waste rock disposal areas. Pit ramps will have a maximum grade of 10% while sections of the haul road outside of the pit will have a maximum grade of 20%. During pre-production, a mining equipment access road will be made along the conveyor corridor to connect the haul road with the main access road.

18.1.4 Support Buildings

18.1.4.1. Truck shop and Warehouse

The truck shop and warehouse building is located near the primary crusher and is an insulated fabric building with an area of 1,115 m². The building will be 12.6 m high at the center, sufficient to allow servicing the articulated haul trucks with their bed fully raised. The shop / warehouse will have 4 man doors and two metal rollup doors, one on each end of the building.

The center of the building will be used for truck servicing, with the side areas of the building used for warehouse racking and storage of consumables. Overflow storage will be in adjacent sea containers as required.

Lubricant storage will be on top of a concrete containment area, located adjacent to the warehouse building.

18.1.4.2. Administration and Mine Offices

The administration building will be an insulated fabric building with approximate area of 745 m² and will have four man doors. The administration building will be located below the tailings dam near the base of the mountain, along the road between the plant and the camp.

The administration building will be shared between the mine and process personnel and will have an open plan layout, with cubicle partitions as required. The administration building will also house the clinic for the mine site.

18.1.4.3. Mill Building

The mill building will be an insulated fabric building, enclosing an area of 2,000 m² (37 m x 55 m x 15 m high). All of the plant equipment will be located inside the building with the exception of the CIL tanks and the stacking system. There will also be sufficient area for workshop / maintenance activities inside the mill building. The building will have two roll-up doors allowing crane and fork-lift access indoors as required.

The building will be a contained area which drains into the leach pad and tailings pond.

18.1.4.4. Reagents Storage

All reagents will be stored in 40' sea-containers adjacent to the plant and leach pad.

18.1.5 Mine Camp

The mine camp will be used for both construction and operation and will have a maximum capacity of 108 persons. The camp will consist of insulated fabric modules, with 25 each four-person modules, 8 single manager rooms within one module, two centralized bathroom / shower modules, a laundry module, and a cafeteria / kitchen module.

The manager module will have eight individual rooms each with its own bathroom. The module will have two personnel doors, twelve windows, electrical lighting, and a heating and air distribution system.

Each four-person sleeper module will have an approximate area of 21 m². The four-person module will have one personnel door, four windows, electrical lighting, and a heater package. The four-person sleeper modules will share two 2.4 m x 6.1 m centralized bathroom modules.

The kitchen / cafeteria module will be a heated insulated fabric building with an area of 335 m². A television and game tables will provide some recreation for staff.

18.1.6 Laboratory

The Tiger Gold Project includes a modular / containerized laboratory complete with sample preparation, fire assaying, and wet lab with atomic absorption spectroscopy (“AAS”). The lab will have capacity to process 200 rock samples per day and 100 solution samples per day.

18.1.7 Other Facilities

An excavated landfill with safety berm will be located between the camp and plant site and will have the capacity to contain 2,000 m³ of domestic and construction waste.

18.2 Power Supply, Communication Systems & IT

18.2.1 Diesel Fired Generator Power Plants

Electrical power will be generated on site by diesel fired generating sets. There will be a main power plant located near the main process plant facilities; another dedicated generator for the primary crusher, and a third at the camp site.

18.2.1.1 Main Power Plant

The main power plant includes two diesel fired 1,750 kW generators (one operating and one standby), switchgear, and all required fuel equipment (filters, pumps, tanks, etc.).

The main power plant will be located between the process plant and tailings dam. The infrastructure to be supplied with electric power from the main power plant are:

- Conveying systems
- Heap leach systems
- Process & recovery plant
- Refinery
- Thickening
- Reagents
- Water distribution
- Laboratory
- Services buildings (administration building, mine workshop, etc.), and

- Tailings and neutralization.

The total average power draw of this infrastructure is estimated to be 1,156 kW.

The primary crusher module (mineral sizer and feeder) will have an on-board 330 kW generator that supports the module independent of the other circuits.

Two 250 kW diesel generators will be installed at the camp site to provide the required electrical power, one unit operating and the other unit on standby.

18.2.1.2. Fuel Storage

A vendor supplied bladder-tank farm will be located on the south facing hillside below the leach pad area. The platform is designed to accommodate 55 horizontal bladder tanks (91,000 liters capacity each), for a total of 5,000,000 liters of diesel, sufficient for an entire operating season. The bladder tank area will be a bermed containment area with an access road along one side.

Due to the winter road only access to the project site, fuel for the spring, summer and fall operations will be brought in during the winter and stored for use throughout the rest of the season. Fuel consumption during winter months will be reduced due to suspension of processing operations, and will be supplied as necessary via the winter road.

Fuel will be distributed from the bladder-tank farm to the mine equipment, generator station, primary crusher generator, and the camp generator by an on-site fuel truck.

18.2.2 Site Power Distribution

The main power plant lies in close proximity to the process plant and will supply 600 V through short interconnects directly to the plant areas. The overland conveyor and bridge stacker will have a step-up transformer (600 V to 4.16 kV) with supply cables mounted to the side of the overland conveyor. The mine warehouse will be supplied from the line feeding the overland conveyors.

A small 600 V line will extend from the generator building to the administration building.

The primary crusher module will be supplied by an on-board independent generator.

Camp facilities and the airstrip will be on a 600 V grid of short interconnections.

18.2.3 Communication Systems & IT

Due to the isolated location a reliable satellite communication system will be required to support operations and general administration. A permanent satellite dish with internet service will be installed. Additionally, there is an existing terrestrial phone line to Keno Hill and it may be possible to install a repeater to provide additional phone service to the Project. This has not been investigated in detail for this study.

The primary communications / server room will be located in the administration building.

18.3 Water

The process water balance shows that peak demand will be 16 m³/h during the summer months. A similar amount will be required for mining dust suppression. This water can be obtained from nearby creeks or the Beaver River.

Water from rain and snow accumulated in the tailings impoundment will be used first for make-up water needs but will generally be consumed during the first operating month of the season.

More detailed studies of water requirements and supply options will be necessary in further stages of engineering; however the Project area has multiple sources of water nearby, and groundwater wells could be an option if required.

Water for the camp will be taken from the Beaver River or nearby streams and treated with a small water treatment plant, maintaining a head tank of potable water.

18.3.1 Sewage

One Sewage Treatment Plant (“STP”) module will be installed at the camp site to handle sewage from all washrooms, kitchen and laundry room.

The camp STP will be a package plant with aeration and clarifier tanks and will treat sewage at a rate of 75 m³/d. The treated effluent will meet all environmental and statutory requirements and be suitable for discharge into the natural environment.

At the plant site, there will be a standard septic / drainfield situated in the vicinity of the administration building, which will also serve the process plant sanitary facilities.

18.3.2 Effluents

The Project will have no water discharge to the environment, aside from treated camp wastewater, and possibly some seasonal dewatering from the pit areas.

19.0 MARKET STUDIES AND CONTRACTS

Gold and silver are sold through commercial banks and metal dealers and are easily transacted. Sales prices are obtained based on world spot or London fixes. The gold price used for the base case cash flow analysis is \$US 1,250/oz (equivalent \$CAD 1,359 / oz).

Sensitivities with variable price projections are also considered.

20.0 ENVIRONMENTAL SETTING

The proposed development area of the Tiger Gold Project is located within the Yukon Plateau-North ecoregion of the Yukon, approximately 143 km northeast of Stewart Crossing, 98 km northeast of the community of Mayo, and 55 km northeast of Keno City. The ecoregion within which the property is located is characterized by a series of plateaus and valleys located northeast of the Tintina Trench. The Tiger Gold Project, central within the Rau Property, is situated in the Nadaleen Range of the Selwyn Mountains and is drained by creeks that flow into the Rackla and Beaver Rivers, which are both part of the Yukon River watershed.

Local topography is alpine to sub-alpine and features north- and south-trending rocky spurs and valleys that flank a main east-west trending ridge. Elevations range from 725 m alongside the Beaver River in the center of the claim block to 1,800 m atop a local peak, referred to as Monument Hill. Outcrop is most abundant near ridge crests and in actively eroding creek beds. Most hillsides are talus covered at higher elevations and are blanketed by glacial till at lower elevations. Soil development is moderate to poor in most areas. Forest cover is comprised mainly of white pine and black and white spruce up to elevations of 1,500 m. At higher elevations shrub birch, scattered pine, white spruce and subalpine fir form the forest cover with lichen understorey.

Vegetation thins to shrub and lichen tundra with increasing elevation, with tree line in the vicinity of the property at about 1,500 m. The density and size of vegetation gradually increases on lower slopes, and the valley floors are well treed with mature black spruce. The understorey typically consists of low shrubs and moss. Moderately steep, south facing slopes are well drained and are often lightly forested with poplar. Steep, north facing slopes are usually rocky outcrop and talus. Gentler, spruce- and moss-covered terrain exhibits widespread permafrost. Much of the overburden in the region is associated with the most recent Cordilleran ice sheet, the McConnell glaciation, that is believed to have covered south and central Yukon between 26,500 and 10,000 years ago (Yukon Geological Survey, 2010).

Temperatures in the ecoregion are the most extreme of the Yukon ranging from -62°C to +36°C in the valley areas, with higher terrain experiencing less extreme ranges in temperature. Annual average precipitation of the ecoregion is approximately 300 mm with areas in the east receiving upwards of 600 mm of precipitation (Matrix, 2010). The climate at the Rau Property is typical of northern continental regions with long, cold

winters, truncated fall and spring seasons and short, mild summers. Although summers are relatively mild, snowfall can occur in any month at higher elevations.

The proposed winter access road route is situated in the valley between the Davidson Range and Patterson Range, approximately 4.0 km southwest of McQuesten Lakes (Matrix, 2010).

20.1 Baseline Environmental Studies Overview

The Tiger Gold Project is located within a larger property (the Rackla Gold Project), which has been the focus of increasingly promising exploration in recent years. Because of the widespread and increasingly advanced exploration throughout the district, ATAC has developed a fairly robust baseline environmental characterization that is anticipated to provide a solid basis of information to support environmental and socioeconomic assessment and permitting under Yukon and Federal legislation for advanced development. Yukon's mining project environmental evaluation, permitting and licensing regime is described in Section 20.3 of this report.

The following overview, presented in Table 20-1, represents the current status and principle investigator for relevant environmental studies on the Property, along with identified areas where further studies will be necessary as the project progresses.

**Table 20-1
Environmental Studies Overview**

	Source	Adequacy Assessment	Network Coverage	Data Frequency	Important Issues Identified	Comments
Water Quality-Surface Water	J. Gibson Environmental Consulting	Good quality assessment conducted on quarterly basis since 2007, and monthly as of July 2012.	Good for stage of project, with the possibility that additional water quality license monitoring and compliance points will be added to the network during Type A Water Use Licensing.	Good	Minor exceedance of <i>CCME Guidelines for Aquatic Life</i> for Selenium in five of twelve water quality stations; some Iron, Aluminum and Zinc exceedance in stations.	None of the five stations with high baseline levels for metals are directly affected by the Tiger Gold Project.
Hydrology – Surface Water, and Ice Thickness for proposed crossings	J. Gibson Environmental Consulting	Good	N/A	N/A	None identified	Continue monthly program; Important to also collect flow measurements at water quality stations as licensing is increasingly setting maximum total metal loadings in receiving environment monitoring rather than just point-source concentrations.
Hydrology – Subsurface Groundwater Quality and Characterization	N/A	Gap Identified. Detailed understanding of nature and characteristics of groundwater will be required to support advanced mine development licensing.	No data collected to date.	N/A	N/A	A subsurface hydrological investigation will need to be undertaken prior to future stages of study. Data should be collected and analyzed so as to provide an accurate characterization of groundwater depth, flow & quality, where potentially affected by pit, leach pad and tailings development.
Wildlife	Laberge Environmental	Good; reports from latest work not yet received; (gaps assumed to be reported on include wolverine, pika, raptors, waterfowl).	Good	N/A	N/A	Identified data gaps to be covered in forthcoming report; will include bear denning survey.
Vegetation	Laberge Environmental	Good	Good	N/A	None identified	Report from rare plant assessment not yet received.

	Source	Adequacy Assessment	Network Coverage	Data Frequency	Important Issues Identified	Comments
Heritage	Matrix Research	Heritage Resource Overview Assessment (“HROA”) and Heritage Resource Impact Assessment (“HRIA”) completed for access road, airstrip: good for stage of project	HRIA was conducted on high potential areas (included selected physical testing) and identified several pre-contact and some modern era heritage sites along the access route. This presents the expectation that more may be found in valleys around lakes. Caution is urged during land disturbance activities.	NA	21 pre-contact and 2 post-contact archaeological sites were identified on the access route during the HRIA, with numerous areas of high archaeological potential. This may have implications for road construction, and will be addressed as terms and conditions of Mining Land Use licensing	Once the final mine plan/project footprint is determined, evaluate the existing HRIA work to determine any requirement for additional site work (HROA identified several areas of high potential along the access route, but nothing at proposed development locations)
Geochemical Characterization	N/A	Gap identified	N/A	N/A	No ARD / metals leachate issues are expected, due to carbonate host rocks and negligible sulfides.	Nevertheless, geochemical characterization should be commenced prior to future study, for all representative lithologies. Static ABA tests should suffice to commence assessment under the Yukon Environmental and Socioeconomic Assessment Act, with kinetic testing possibly required for water licensing if identified during preliminary static assessment. Geochemical characterization will also be required for borrow sources and overburden stripping areas.
Climate	J. Gibson Environmental Consulting	Very Good	N/A	N/A	N/A	Localized temperature, precipitation, and wind data collection (including snowpack surveys) to continue. Detailed localized climate data will be required for senior permitting.

20.2 Tailings and Waste Rock Disposal Plan

The preliminary waste rock dump size and location has been developed by Tetra Tech, with details presented in Section 16. A description of the tailings impoundment design and operations designed by KCA are presented in Section 17. Implications for mine closure are discussed in the closure costing section below.

20.3 Water Management

Solution balance and water management for the process plant are discussed in Section 17.

All facilities will be constructed with appropriate diversions to prevent surface water run-off from entering the process system.

Sediment traps will be constructed at intermediate locations to allow surface water run-off that drains from disturbed areas to settle prior to naturally overflowing to the environment.

Future work will include rinse and neutralization tests to determine the rinse cycle required for spent heap leach materials as well as to what degree rinsing will affect the water balance.

20.4 Project Permitting Requirements

Mining development in Yukon is governed by a multi-staged process that can be roughly divided into two groups:

- a) *Senior permits and licenses (eg. Quartz Mining License, Water Use License, etc.)* – The acquisition of each of these authorizations requires substantial and detailed submission documentation (e.g. project description, socioeconomic and environmental baseline characterization, potential environmental effects, proposed mitigative measures to address potential effects, monitoring plan, component-specific adaptive management plans, and closure plan). Each typically take several months to complete, and will drive the timelines for project development;

- b) *Minor permits and licenses (eg. camp septic, propane, electrical, solid waste, building permits for site infrastructure, etc.)* – These are fairly straightforward to acquire, require relatively minor documentation in application, and can be secured as project develops, typically without impact to project timeline.

The discussion presented in this report will only be concerned with an assessment of the senior permits and licenses, as it is assumed that the numerous minor permits will be secured as necessary to support the mine development time schedule. Prior to production, the Tiger Gold Project will require the following senior authorizations, shown below in Table 20-2.

Table 20-2
Senior Authorizations Required

Mine criteria trigger	Authorization Required	Issuing Agency	Legislation
>100 t/d gold mine	Yukon Environmental and Socioeconomic Assessment Act (“YESAA”) Decision Document	Issued by Decision Body (Government of Yukon, Energy, Mines & Resources), after evaluation at the Executive Committee level process of the Yukon Environmental and Socioeconomic Assessment Board (“YESAB”)	YESAA, <i>Assessable Activities, Exceptions and Executive Committee Projects Regulations</i>
Commencement of commercial production	Quartz Mining License	Yukon Government, Energy Mines & Resources	Quartz Mining Act, <i>Mining Land Use Regulations</i>
Use of water for milling, use of > 300 cubic meters per day, deposit of a waste	Type A Water Use License	Yukon Water Board	Waters Act, <i>Waters Regulations</i>

As indicated in Table 20-2, the first step in mine permitting in Yukon is the environmental and socioeconomic assessment conducted under the Yukon Environmental and Socioeconomic Assessment Act (“YESAA”). While development of the Tiger Gold Project will require more senior review from the Executive Committee as noted above, it is nevertheless instructive to view the conclusion reached by the Mayo Designated Office of the Yukon Environmental and Socioeconomic Assessment Board (“YESAB”) in 2012, in their evaluation of the property access road:

“Based on the comments submitted and other relevant considerations, three valued components were identified: wildlife and wildlife habitat, environmental quality and other land users. The Mayo Designated Office has determined that the Project will have significant adverse effects on the above-mentioned valued components. The application of existing legislation, the Proponent’s mitigations (Appendix A), as well as the recommended mitigation measures (listed below) are adequate to mitigate the significant adverse effects of the Project.” YESAB Mayo Designated Office, Project 2013-0116.

YESAB evaluation reports typically provide recommendations for the development of adaptive management plans for specific components of the mine, which will then be incorporated either into the Quartz Mining License (terrestrial effects mitigation) or the Water Use License (aquatic effects mitigation). Management plans will therefore include, at a minimum:

- Fish and fish habitat management plans, including habitat impact mitigation and compensation plans that satisfy section 35(2) of the Fisheries Act (if necessary);
- Access road management plan, including traffic management, maintenance and safety on access roads and the construction site;
- Waste rock management plan and tailings management plan;
- Metal Leachate / Acid Rock Drainage prediction, prevention, and management plan;
- Water management plan;
- Air emissions and fugitive dust management plan;
- Noise management plan;
- Materials handling and management plan;
- Soil management plan;
- Hazardous goods storage and management plan;
- Erosion control and sediment control plan;
- Vegetation management plan;
- Wildlife management plan;
- Spill contingency and emergency response plan;
- Domestic and industrial solid waste management plan;
- Airport and aircraft management plan;
- Archaeological and heritage site protection plan; and
- Construction plan, including provision for environmental supervision.

Preliminary stages of mine development can be and typically are authorized by early stage mine permitting, such as a Type B Water Use License for construction of permanent water crossings (supported by a Designated Office level YESAB assessment) and a Class IV Mining Land Use Authorization for construction of various mine components (again supported by a Designated Office level YESAB evaluation).

The authorizations in Table 20-2, listed in the order in which they will be acquired, will be issued for the full LOM period as described in this PEA. The Water Use License may require modification of the security held under the Quartz Mining License. The project will also be subject to the *Metal Mine Liquid Effluent Regulations* under the federal Environment Act, which will set monitoring requirements and criteria for all discharges emanating from the mine and its various component infrastructure (e.g. pit, heap, tailings pond, etc.).

Approval of a Detailed Decommissioning and Reclamation Plan will be a requirement of the Quartz Mining License. This document will be used to set security requirements which will need to be met prior to authorization of the commencement of commercial production. Conceptual closure measures are outlined in Section 20.6 of this report, and have been used as basis upon which to calculate an estimate of security.

Due to the nature of the proposed Project and geology of the deposit, environmental assessment and permitting is likely to proceed without significant problems. Important environmental considerations include the fact that the Tiger Gold Project will process only oxide materials. Although a small amount of low grade sulfide material is anticipated to be handled as waste, this material will be segregated and encapsulated in a dedicated section of the waste dump.

The abundance of carbonate host rocks with negligible sulfide content, the position of the open pit, leach pad and tailings away from watercourses, recycling of process water and complete detoxification of cyanide will underscore the environmental assessment and subsequent licensing. The cell-based heap leach concept with ongoing progressive reclamation should also be favorably received.

20.4.1 Current Permits

There is an existing current Class 3 Exploration Permit for the Rau Property, including the Tiger Deposit, which will be expiring in August, 2014.

Renewal of this permit has been approved by YESAB (2014-0052) and is awaiting issuance of new permit from Energy Mines & Resources.

A Territorial Land Use Permit for the Wind River Trail was recently renewed, including a new YESAB decision (2013-0116). This permit allows use of the existing Wind River Trail to haul supplies (approximately 140 tonnes of fuel and supplies annually, for 2013 / 2014 & 2014 / 2015 with possible extension to 2015 / 2016) during winter months.

20.5 Socioeconomic, Community Engagements

The Tiger Gold Project is located within the Traditional Territory of the First Nation of Nacho Nyak Dun (“NND”), whose people have lived a subsistence lifestyle off the land for centuries, and who since concluding a Land Claim Agreement with the Government of Canada have begun to develop a capacity to provide skilled personnel and a broad range of services to mining projects.

In recognition of these facts, ATAC has developed a good working relationship with NND and in January of 2014 the parties renewed the Exploration Cooperation Agreement (“ECA”) originally concluded in October 2010. The ECA provides a framework within which exploration activities and environmental regulatory processes for the company’s Rackla Gold Project have been and will continue to be carried out.

In addition to being host of mining in the area for nearly a hundred years (primarily by the former United Keno Hill Mines Ltd.), NND has also been directly involved in modern mining and mine development projects such as Alexco Resource Corp’s Bellekeno Mine and Victoria Gold Inc’s Eagle Gold Project, and numerous other public mining companies whose projects are at the exploration stage. This historical familiarity, enhanced significantly by their recent involvement in the post-land claim era has resulted in NND growing in capacity and sophistication as service providers of their own (e.g. fuel supply, water / sewage, personnel transport etc.) or as joint venture partners with larger specialized contractors (e.g. camp catering, underground contract mining, etc.). Skilled NND personnel are filling employment roles as camp cooks, water treatment plant operators, mill workers, underground miners, road construction heavy equipment operators, environmental monitors, administration staff, exploration technicians, etc. It is expected that ATAC will continue to benefit from this enhanced capacity as the Tiger Gold Project advances.

Documentation of formalized socioeconomic consultation is a requirement for YESAB submissions at the Executive Committee level. ATAC will also need to negotiate an enhanced Impacts Benefit Agreement with NND encompassing production.

The community of Mayo, situated approximately 98 km southwest of the Tiger Gold Project, is historically and currently supportive of mining and another good potential source of employees and service providers.

20.6 Mine Closure / Reclamation Requirements and Costs

All major mine components, such as the waste rock disposal area, leach pad and tailings dam, will be designed for closure. Engineering design and construction techniques will be developed and implemented so as to afford the most efficient closure scenario possible. For example, the waste rock disposal area, to be situated in the upper valley of an ephemeral alpine stream, will be constructed by first selectively placing large boulders of limestone waste rock as the foundation layer. This geochemically benign carbonate layer will act as a french drain to permit spring snowmelt to run through the base of the facility undiminished in quality, quantity or rate of flow.

20.6.1 Conceptual Closure Measures and Cost Estimate

The following measures, shown in Table 20-3, are estimations of the activities that will be required as part of the Detailed Decommissioning and Reclamation Plan, which will be a requirement of an eventual Quartz Mining License. While these closure measures are per force provisional and conceptual due to the early stage of project design, they are believed to be reasonable assumptions upon which an estimate can be made on the value of the security bond that will be required prior to commencement of production.

**Table 20-3
Conceptual Closure Measures**

Component	Closure Measures
Open Pit	Construct earthen safety berm from non-acid generating waste rock above high-angle wall to prevent accidental ingress.
Waste Rock Disposal Areas, ROM Stockpile	Cover all waste rock storage facilities with 1.0 m evapotranspirative granular cover and establish vegetation; PAG waste will be incorporated in a cell of the larger NAG waste dump; design-for-closure construction of waste rock storage facilities will incorporate a French drain built from boulder-sized carbonate rocks placed as initial layer along bottom of WRDA in creek channel, therefore no rehandling of rock at closure is necessary; scarify / grade if necessary to establish natural surface runoff drainage; demolish / bury ROM stockpile pad, test soils for contamination and remove for placement on tailings as required.
Overland Conveyor Belt (includes earthworks)	Salvage steel / components as appropriate and bury refuse in place; scarify / regrade berms, remove any spillage rock and place on las annual heap cell before capping as necessary.
Heap Leach Pad	Heap leach cells will be progressively reclaimed following completion of each leach cycle, consisting of: detoxification, including flushing, rinsing, and water quality sampling verification; covering with 1.5mm HDPE liner and 1.0 m evapotranspirative local fill cover; restoration of drainage; and revegetation.
Process Plant	Remove salvageable components / steel as appropriate, bury refuse in place; and scarify / regrade surface disturbance.
Tailings Facility	Cover with 1.0 m thick evapotranspirative cover constructed from local fill.
Fuel Farm	Remove / salvage as appropriate, bury non-contaminated refuse in place; test soil for hydrocarbon spills and establish / operate local land treatment facility as required.
Haul Roads/Mine Site Roads	Scarify surface; remove culverts / safety berms and restore cross drainage; and allow natural revegetation to occur.
Camp	Remove camp trailers; demolish walkways/power lines etc., salvage as applicable; scarify all cleared areas; and revegetate.
Site Infrastructure (e.g. blasting magazine, laydown area, sediment ponds, etc.)	Remove for salvage as appropriate; sample and analyze soil for contamination and remediate in local treatment facility as necessary; and restore natural drainage pathways.
Compliance Monitoring and Reporting	Contract engineering inspection / reporting by 3rd party; ongoing water quality monitoring; fly-in after year 2.
Revegetation of Surface Disturbances (except open pit)	Manually apply locally sourced seed / fertilizer source to disturbed areas below timberline.
Project Management	Conduct a "Contaminated Site Assessment" as per Yukon Environment Act, with supervision of contractor's first 2 seasons.

Notes:

1. *Closure measures are based on conceptual mine components as currently envisaged, which may change as the Project is further developed.*
2. *Final costs will be developed using 3rd party Yukon contractor heavy equipment rates, and as such will not consider potential reductions in costs that may be obtained if undertaken by mine owner.*
3. *Area calculations for mine component infrastructure and surface disturbances as per project site drawings developed by KCA.*

4. *All closure measures are provisional and estimated – determination of final measures will require public / government / First Nations consultation to determine closure objectives prior to selection of measures to meet those objectives.*
5. *Assumed natural revegetation on all linear disturbances (e.g. roads, conveyor route) and assisted revegetation on aerial disturbances (e.g. Waste Rock Disposal Area).*

20.6.2 Closure Cost Estimate and Security Bonding requirements

Undertaking the measures as outlined above is estimated to cost approximately \$2,012,500, which includes a 15% contingency of \$262,500. The final figure will be agreed upon by ATAC and the Government of Yukon (“Yukon”) after third party technical review. It is expected that the physical work to undertake the measures can be completed within two seasons following cessation of production, with monitoring to take place for 15 years post closure.

Security bonding to address the estimated closure costs will be based on public liability, as determined by Yukon, and is typically required to be submitted in a phased manner, concomitant with estimated existing public liability. Payment of the initial tranche of security is therefore likely to be approximately 50% prior to legal "commencement of production" (a defined set of circumstances, as set out in the Quartz Mining License (“QML”), followed by 25% in year 1, and the final 25% in year 2 with revision of security set out in the QML and based on actual circumstances at site.

The actual percentage of closure costs to be covered by an initial tranche of security bonding will be set by Yukon to address the estimated liability at site prior to mining. Repayment of the security bond will be based on agreed inspection and sign off by Yukon that the measures have been undertaken as envisaged and that successful preliminary implementation has been demonstrated. Yukon will issue a Certificate of Closure once all obligations have been met. Provisions for temporary closure, along with criteria that trigger the initiation of temporary closure, will also be terms and conditions of the QML.

21.0 CAPITAL AND OPERATING COSTS

21.1 Capital Expenditures

The capital cost estimate for the Tiger Gold Project has been prepared by KCA and Tetra Tech with input from ATAC and is considered to have an accuracy of $\pm 35\%$. Costs are reported in 1st Quarter 2014 Canadian dollars unless otherwise noted. Where applicable, an exchange rate of 1.00 CAD = 0.92 USD was used.

According to standards established at the outset of the Project, pricing of equipment, material and labor was estimated according to the following guidelines:

Included:

- Benchmarking with similar projects in Canada
- Mine equipment quotations specifically for the Project
- Data from past projects
- Local supplier quotations
- Labor rates

Excluded:

- Lost time due to strikes
- Finance charges and interest during construction
- Currency exchange fluctuations
- Escalation

All capital cost estimates are based on the purchase of equipment quoted new from the manufacturer or estimated to be fabricated new.

A summary of the capital expenditures is presented in Table 21-1.

**Table 21-1
Capital Expenditures Summary**

Plant Pre-Production Direct Costs	Supply Cost	Install Cost	Grand Total
Area 0010 - Site & Utilities General	\$3,599,742	\$477,652	\$4,077,394
Area 0113 - Crushing & Conveying	\$8,106,086	\$1,846,004	\$9,952,091
Area 0119 - Scrubbing / Classifying	\$1,302,064	\$440,999	\$1,743,063
Area 0122 - CIL Leach	\$2,602,861	\$547,761	\$3,150,621
Area 0125 - Thickening	\$1,338,779	\$303,783	\$1,642,562
Area 0128 - Recovery	\$8,032,562	\$842,934	\$8,875,496
Area 0131 - Refinery - Included in Recovery	\$0	\$0	\$0
Area 0134 - Reagents	\$591,438	\$205,434	\$796,872
Area 0362 - Power	\$2,251,498	\$125,152	\$2,376,650
Area 0366 - Facilities	\$6,037,641	\$1,227,840	\$7,265,481
Area 0137 - Heap	\$1,122,231	\$2,632,501	\$3,754,733
Area 0360 - Water	\$596,008	\$192,066	\$788,074
Area 0470 - Tailings & Detox	\$518,956	\$1,907,719	\$2,426,675
Plant Total Pre-Production Direct Costs	\$36,099,867	\$10,749,846	\$46,849,713
Spare Parts			\$905,781
Sub Total with Spare Parts			\$47,755,494
Contingency (20%)			\$9,551,099
Plant Total Pre-Production Direct Costs with Contingency			\$57,306,592

Additional Pre-Production Capital Costs	Total
Indirect Field Costs (including contingency)	\$4,880,400
Initial Fills	\$712,501
EPCM	\$7,449,857
Process Working Capital (60 Days)	\$5,388,286
Sub Total Pre-Production Process Cost	\$75,737,636
Mining Fleet & Pre-Production Stripping/Stockpiling (including contingency)	\$22,624,004
Total Pre-Production Capital Cost	\$98,361,640

Sustaining Capital Costs	Total
Process Sustaining Cost (including contingency)	\$24,490,963
Mining Sustaining Cost (including contingency)	\$2,017,112
Sub Total Sustaining Capital Cost	\$26,508,075
Total LOM Capital Cost	\$124,869,716

21.2 Mining Capital

Mining capital cost requirements consist of pre-production capital and sustaining capital. The mining pre-production capital includes the following:

- Mining equipment acquired during the pre-production period,
- Pre-production mining operating costs (stripping and stockpiling), and
- 25% of the sustaining capital required during the first year of production as a down payment for the mining equipment purchased during that year.

The recommended mining fleet is presented in Table 21-2. Table 21-3 summarizes the mining pre-production capital cost requirements.

Table 21-2
Summary of Mining Fleet Requirements

Equipment	Qty.
Track Dozer 9.8 ft (2.9 m)	2
Wheel Dozer 12 ft (3.6 m)	1
Grader 12 ft (3.6 m)	1
Water Truck 5000 gal (18,930 L)	1
Service Loader	1
Secondary Drill	1
Vibratory Compactor	1
Integrated Tool Carrier	1
Excavator	1
Flatbed Truck	1
Fuel/Lube Truck	1
Mechanics Service Truck	1
Welder Truck	1
Tire Service Truck	1
Snow/Sand Truck	1
Pickup Truck	4
Mobile Crane	1
Rough Terrain Forklift	1
Shop Forklift	1
Light Plant	8
Dispatch System	1
Mobile Radios	100
Safety Equipment	1
Engineering/Geology Equipment	1
Maintenance Management System	1
Surveying	1

**Table 21-3
Summary of Mining Initial Capital Costs**

Item	Cost (\$ Millions)
Mining Equipment	\$10.11
Pre-production Mining Operating Costs	\$9.93
25% of Year 1 Sustaining	\$0.56
Mining Fleet Contingency	\$2.02
Total Initial Mining Capital Cost	\$22.62

The LOM mining sustaining capital is \$1.68 million plus a contingency of \$336 thousand.

21.3 Process Capital Costs

21.3.1 Process Cost Basis

Process capital costs for the heap leach, CIL, and processing plant have been estimated primarily by KCA with information from ATAC and Tetra Tech.

Each area in the process cost build-up is separated into the following disciplines, as applicable:

- Major earthworks & liners,
- Civil (concrete),
- Structural steel,
- Platework,
- Mechanical equipment,
- Piping,
- Electrical,
- Instrumentation, and
- Infrastructure.

Supply and installation costs are included in the capital cost buildup for each discipline as applicable and are discussed in the following sections. For some disciplines, a combined cost for supply and installation is provided.

Engineering, procurement, and construction management (“EPCM”), indirect costs, and initial fills inventory are added to the total process direct costs.

21.3.2 Freight

Estimates for equipment freight costs have been based on an average percentage of equipment costs. The cost for transport to the jobsite is estimated to average 10.14%. The freight estimate is based on KCA’s experience with similar projects and includes a base estimate of 10% and an additional 0.14% for freight from Mayo to the site.

21.3.3 Customs Fees & Taxes

Customs fees and taxes for items imported into Canada are taken at 3.6% of the equipment cost for this study. All items assumed to be sourced from Canada, including the mineral sizer and conveying system, are not subject to customs fees and taxes.

21.3.4 Installation

Installation estimates for the equipment are based on the equipment type and include all installation labor and equipment usage. The hourly installation labor rates are estimated to be \$65/hr and include provisions for wages, burdens, overhead, and contractor profit.

21.3.5 Major Earthworks & Liners

The required earthworks quantities for the Tiger Gold Project have been estimated by KCA. Quantities for the plant areas are included in the Phase 1 leach pad costs as the proposed plant site area is directly adjacent to the leach pad and tails area. The primary crushing plant and overland conveyor earthworks quantities are calculated separately. It is assumed that these can be constructed only with a dozer / compactor.

The heap leach facility and tailings impoundment (“TI”) will be constructed in four yearly phases with Phase 1 being constructed during the pre-production year. Each year, cut material from the leach pad preparation will be used as compacted fill material for the annual tailings dam raise.

Unit earthworks costs are estimated based on unit mining costs developed by Tetra Tech combined with similar project construction experience using appropriate scale-ups given the remote arctic location. A limited amount of overliner gravel and perforated draincoil pipes are included to provide enhanced drainage to the HLF.

21.3.6 Civil

Civil costs include detailed earthworks and concrete. By design, the Tiger Gold Project consists mostly of modular equipment and requires relatively little concrete. An allowance of 500 m³ has been assumed for all site concrete requirements.

21.3.7 Structural Steel

Structural steel has largely been included in the supplier equipment packages. Where needed, structural steel requirements are based on takeoff lists from similar projects or estimated allowances for structural steel.

21.3.8 Platework

The platework discipline includes the supply and installation of steel tanks, bins, and chutes. All costs were developed factored by tank size from recent quotes in KCA files.

21.3.9 Mechanical Equipment

Costs for mechanical equipment are based on a list developed of all major equipment for the heap leach, CIL, and associated process areas.

Costs for most major pieces of equipment are based on recent equipment quotes. The overland conveyors were factored from similar recent projects by KCA. Certain equipment such as the mineral sizer, scrubber, screw classifier, agitators, strip-circuit and refinery equipment were quoted by suppliers specifically for this project. Costs for minor equipment items are based on a combination of literature, KCA's in-house database, or else reasonable allowances.

21.3.10 Piping and Instrumentation

Capital costs for piping and instrumentation supply were estimated as a percentage of mechanical equipment costs, which vary by process area based on KCA's experience with past projects.

For the heap leach irrigation piping, including headers, sub-headers, and drip tubing, an additional supply allowance of \$100,000 has been included.

21.3.11 Electrical

Electrical supply costs are primarily estimated as a percentage of the mechanical equipment supply cost for each process area and include estimates for installation. The percentage factor applied ranges between 10% and 20%, depending on the area.

21.3.12 Infrastructure

Site infrastructure includes the main winter access road to the mine site. Approximately 24.6 km of winter road upgrades and 51.6 km of new winter road will be required. An additional 8.2 km of new all-season road is required between the camp / air-strip and the project site.

Site buildings include the administration building, mine shop / warehouse, mill building, laboratory, and the man camp. All site buildings except for the lab are designed as insulated prefabricated fabric buildings. The laboratory will include modular lab units. Costs for site facilities have been included in the mechanical equipment discipline.

21.3.13 Spare Parts

Spare parts were estimated at approximately 4% of the mechanical equipment supply cost.

21.3.14 Mobile Equipment

The process department has the following mobile equipment:

- 1 ea. 60 ton crane,
- 1 ea. 4.5 t telehandler,
- 1 ea. D4G dozer,
- 1 ea. 966 loader,
- 2 ea. personnel vans, and
- Misc. light vehicles.

The processing department will use two of the light vehicles purchased for the construction phase of the project and the remainder of the six construction pickups trucks and flatbed will be used for other departments at site. Process mobile equipment is estimated at \$1.7 million.

21.4 Construction Indirect Costs

21.4.1 Indirect Capital Costs

Indirect capital costs include contractor's costs for items such as temporary construction facilities, quality control, survey support, warehouse and fenced yards, support equipment, security, etc. These costs have been estimated by KCA based on experience with similar projects.

Construction indirect costs are presented in Table 21-4.

**Table 21-4
Construction Indirect Costs**

Indirect Field Costs	Total
Misc. Hotels, etc.	\$115,000
QA/QC Earthworks, Liner, and Concrete	\$450,000
Surveying	\$195,000
Construction Camp Set-Up Provision	\$500,000
Construction Camp Operations	\$895,000
Misc. Support Equipment	\$200,000
Office Equipment (Copiers, Printers, Computers, Plotter)	\$100,000
Clinic	\$40,000
Construction Vehicle O&M (6 Pickups + Flatbed)	\$175,000
Construction Phone / Internet	\$50,000
Construction Power Opex and Rental	\$632,000
Security Contractor	\$50,000
Outside Consultants / Vendor Reps	\$100,000
Construction Warehouse (Core Shed)	\$150,000
Construction Office Trailers (Purchase & set-up)	\$90,000
Air Charter Service	\$325,000
Sub-Total Indirect Costs	\$4,067,000
Indirect Contingency	20% \$813,400
Total	\$4,880,400

21.4.2 Engineering, Procurement, and Construction Management

The estimated EPCM cost for the development, construction, and commissioning of the Project are based on a percentage of the direct capital costs. The total estimated cost for EPCM is \$ 7.45 million, or 13% of the Project direct costs. The percentage is based on KCA's experience with similar sized projects.

The EPCM costs cover services and expenses for the following areas:

- Project Management,
- Detailed Engineering,
- Engineering Support,
- Procurement,
- Construction Management,
- Commissioning, and
- Vendors Reps.

21.4.3 Contingency

A 20% contingency has been applied to both direct and indirect costs.

21.4.4 Working Capital

A 60 day working capital line item is included in the Tiger Gold Project cost estimate. This includes all costs required for operation of both the process and general & administrative (“G&A”). The total working capital for the Project is \$5.4 million.

21.5 Sustaining Capital

Sustaining capital costs will include additional costs for the leach pad and tailings expansion each year, as well as purchase of additional mining equipment in year 1. Leach pad and tailings construction will be performed during the summer each year through the life of the project. A HDPE liner will be used to cap the inactive leach areas, and will be installed as part of yearly progressive reclamation once each leach cycle finishes.

The LOM process sustaining capital for the Tiger Gold Project, including 20% contingency, is \$24.5 million.

The LOM mining sustaining capital is \$1.68 million plus a contingency of \$336 thousand.

21.6 Reclamation and Closure

Reclamation and closure costs are estimated at \$2.01 million, which includes a contingency of 15%. These costs are discussed in detail in Section 20 of this report.

21.7 Operating Costs

The Tiger Gold Project annual operating costs were estimated for mining, processing, general & administration, and are summarized in the following section based upon information presented in earlier sections of this report. Mining costs were determined by Tetra Tech and are estimated to be \$4.83/t mined for the life of mine, including pre-production. LOM operating costs for process and G&A are estimated to be \$27.21/t material processed.

21.7.1 Mining Operating Costs

The mining operating costs were estimated from equipment productivity calculations, and more generally from “Mine and Mill Equipment Costs – An Estimator’s Guide 2013”. The annual equipment utilization hours were derived from calculated available hours less estimated operating delays, and then applied to the hourly equipment costs to calculate direct mining operating costs.

21.7.1.1. Relevant Consumables Prices

Table 21-5 shows the consumables pricing used in the calculation of mining operating costs.

**Table 21-5
Relevant Consumables Prices**

Description	Unit	Price
Fuel	\$/L	1.30
Lube	\$/L	3.32
Emulsion	\$/t	957
ANFO	\$/t	935

21.7.1.2. Labor

Annual labor operating costs were calculated using the yearly cost per labor category, equal to an average of salaries from similar mining studies. The yearly cost of each labor category includes a base salary and 40% benefit package.

21.7.1.3. Blasting Services

The mine will contract out blasting services, including the supply of a mix truck and trained personnel to carry out the delivery of the explosive mix to the drill holes and blasting operation. The fixed cost of this service is estimated at \$0.05/t mined, and does

not include consumables. Based on the geotechnical report (Golder, 2014), blasting will be performed only on waste rock while oxide material will be excavated directly by the hydraulic excavator.

21.7.1.4. Mining Operating Cost Summary

Tables 21-6 through 21-8 summarize the mining operating costs per activity for the pre-production period, the production period, and the LOM.

Table 21-6
Mining Operating Cost Summary – Pre-production Period

Mining Cost Item	\$ Millions	\$/t mined
Drilling	\$0.10	\$0.067
Blasting	\$0.38	\$0.256
Loading	\$0.25	\$0.164
Hauling	\$0.71	\$0.476
Support Equipment	\$0.85	\$0.569
Ancillary Equipment	\$0.67	\$0.450
Dewatering	\$0.08	\$0.050
Labour	\$6.87	\$4.759
Other	\$0.01	\$0.008
Total	\$9.93	\$6.619

Table 21-7
Mining Operating Cost Summary – Production Period

Mining Cost Item	\$ Millions	\$/t mined
Drilling	\$1.45	\$0.120
Blasting	\$3.97	\$0.329
Loading	\$2.00	\$0.166
Hauling	\$5.06	\$0.419
Support Equipment	\$2.99	\$0.248
Ancillary Equipment	\$2.45	\$0.203
Dewatering	\$0.60	\$0.050
Labour	\$34.79	\$2.882
Other	\$0.47	\$0.039
Total	\$53.79	\$4.455

**Table 21-8
Mining Operating Cost Summary – LOM**

Mining Cost Item	\$ Millions	\$/t mined
Drilling	\$1.55	\$0.114
Blasting	\$4.36	\$0.321
Loading	\$2.25	\$0.166
Hauling	\$5.78	\$0.426
Support Equipment	\$3.84	\$0.283
Ancillary Equipment	\$3.13	\$0.230
Dewatering	\$0.68	\$0.050
Labour	\$41.66	\$3.069
Other	\$0.48	\$0.035
Total	\$63.72	\$4.695

21.7.2 Process Operating Costs

Process operating costs, including labor, for the Tiger Gold Project were estimated by KCA for the heap leach, CIL and related process areas.

Operating costs for the process-related areas of the Project have been estimated from first principles. Labor costs are estimated using project-specific staffing, salary, wage, and benefit requirements. Unit consumptions of materials, supplies, power, water, and delivered supply costs are also estimated.

Table 21-9 shows the process operating cost summary.

**Table 21-9
Process Operating Cost Summary**

Item	Units	Qty	Unit Cost	Yearly Cost	\$/t Processed
<u>Labor</u>					
Process	ea	48		\$3,181,281	\$6.167
Laboratory	ea	9		\$504,731	\$0.978
Subtotal				\$3,686,012	\$7.145
<u>Crushing & Conveying</u>					
Power	kWh/t	0.854	\$0.436	\$192,270	\$0.373
MMD Sizer Generator	L/h	84.9	\$1.300	\$313,892	\$0.608
966 Loader	h/mo	252	\$48.91	\$64,028	\$0.124
Wear & Maintenance	lot			\$218,678	\$0.424
Subtotal				\$788,869	\$1.529
<u>Scrubbing & Classifying</u>					
Power	kWh/t	2.093	\$0.436	\$470,978	\$0.913
Wear & Maintenance	lot			\$140,178	\$0.272
Subtotal				\$611,156	\$1.185

Item	Units	Qty	Unit Cost	Yearly Cost	\$/t Processed
<u>CIL Leach</u>					
Power	kWh/t	1.917	\$0.436	\$431,435	\$0.836
Wear & Maintenance	lot			\$112,143	\$0.217
Subtotal				\$543,578	\$1.054
<u>Thickening</u>					
Power	kWh/t	0.061	\$0.436	\$13,649	\$0.026
Flocculant	kg/t	0.08	\$4.41	\$100,029	\$0.194
Maintenance Supplies	lot			\$67,286	\$0.130
Subtotal				\$180,964	\$0.351
<u>Recovery</u>					
Power	kWh/t	0.318	\$0.436	\$71,548	\$0.139
Diesel (Boiler & Kiln)	L/mo	35,623	\$1.30	\$240,556	\$0.466
Carbon	kg/a	20,706	\$3.30	\$68,421	\$0.133
Misc. Operating Supplies	lot			\$112,143	\$0.217
Maintenance Supplies	lot			\$8,411	\$0.016
Subtotal				\$501,078	\$0.971
<u>Refinery</u>					
Power	kWh/t	0.351	\$0.436	\$78,965	\$0.153
Fluxes	kg/oz	0.075	\$1.61	\$8,675	\$0.017
Diesel	L/mo	1,202	\$1.30	\$8,116	\$0.016
Misc. Operating Supplies	lot			\$11,214	\$0.022
Maintenance Supplies	lot			\$11,214	\$0.022
Subtotal				\$118,185	\$0.229
<u>Heap</u>					
Power	kWh/t	0.231	\$0.436	\$52,069	\$0.101
Piping/Drip Tube	lot			\$25,793	\$0.050
Misc. Operating Supplies	lot			\$11,214	\$0.022
Maintenance Supplies	lot			\$5,607	\$0.011
Subtotal				\$94,683	\$0.184
<u>Reagents</u>					
Power	kWh/t	0.089	\$0.436	\$19,931	\$0.039
Cyanide (Ore) + Detox Loss	kg/t	0.73	\$4.00	\$1,500,267	\$2.908
Cyanide (Elution)	kg/a	1,724	\$4.00	\$6,895	\$0.013
Caustic	kg/a	5,171	\$1.01	\$5,228	\$0.010
Lime	kg/t	4.8	\$0.50	\$1,225,550	\$2.376
Hydrochloric Acid	L/a	78,000	\$0.47	\$36,457	\$0.071
Antiscalant	L/a	1,122	\$2.77	\$3,110	\$0.006
Maintenance Supplies	lot			\$5,607	\$0.011
Subtotal				\$2,803,044	\$5.434
<u>Water Distribution</u>					
Power	kWh/t	0.756	\$0.436	\$170,193	\$0.330
Maintenance Supplies	lot			\$5,607	\$0.011
Subtotal				\$175,800	\$0.341
<u>Laboratory</u>					
Assays, Solids	#/d	100	\$5.43	\$84,693	\$0.164
Assays, Solutions	#/d	100	\$1.63	\$25,408	\$0.049
Miscellaneous Supplies	lot			\$5,607	\$0.011
Subtotal				\$115,708	\$0.224
<u>Support Services</u>					
Buildings & Misc. Power	kWh/t	1.488	\$0.436	\$334,974	\$0.649
Light Vehicles (6)	km/d	600	\$0.38	\$35,571	\$0.069

Item	Units	Qty	Unit Cost	Yearly Cost	\$/t Processed
Maintenance Trucks (1)	km/d	125	\$0.49	\$9,528	\$0.018
Telehandler	h/mo	180	\$7.61	\$7,114	\$0.014
Crane (60-t)	h/mo	14	\$54.35	\$3,952	\$0.008
D4 Dozer	h/mo	20	\$32.61	\$3,388	\$0.007
Maintenance - Gensets	lot			\$70,000	\$0.136
Subtotal				\$464,528	\$0.900
Detox					
Power	kWh/t	0.337	\$0.436	\$75,844	\$0.147
Hydrogen Peroxide (50%)	kg/d	412	\$1.43	\$92,148	\$0.179
Copper Sulfate	kg/d	14.4	\$3.15	\$7,074	\$0.014
Miscellaneous Supplies	lot			\$112,143	\$0.217
Subtotal				\$287,208	\$0.557
TOTAL COST (Process Only)				\$10,370,814	\$20.104
G&A				\$2,418,822	\$4.689
G&A Labor				\$1,248,645	\$2.421
Subtotal					\$7.109
TOTAL COST (Process and G&A)				\$14,038,281	\$27.214

21.7.2.1. Basis of Process Operating Cost Estimate

The process operating costs are based upon ownership of all process-related production equipment and site facilities, as well as the owner employing and directing all operating, maintenance, and support personnel.

The operating costs have been estimated and are presented without any added contingency allowances. The processing, support, and general & administrative operating costs are considered to have an accuracy range of +/- 35%.

Operating cost estimates have been based upon information obtained from the following sources:

- Project metallurgical test work and preliminary process engineering,
- Recent KCA project file data, and
- Experience of KCA staff with other similar operations.

Where specific data does not exist, cost allowances have been based upon consumption and operating requirements from other similar properties for which reliable data exists.

All costs are presented in Q1 2014 CAD.

All applicable taxes have been included in the consumable unit costs.

21.7.2.2. Process Labor and Wages

Staffing will be primarily by Canadian nationals, with supply from the Yukon labor force as a priority. The work force will consist of approximately 48 persons in the plant areas, 12 in G&A and 9 persons in the laboratory. The wages and salaries for Project personnel are shown in Table 21-10. Labor rates for hourly and staff employees, along with associated benefits, have been provided by KCA.

It is generally intended that the general manager and the off-site salary staff will be employed year-round. The site hourly workers will only work for 158 days per year with the exception of a small 11-person skeleton crew which would arrive two weeks early and leave 50 days later than the rest of the main work force. During the operating season the shift schedule will be 12 hour shifts with a 14 days of work and 7 days rest rotation.

Table 21-10
Summary of Process Labor Requirements and Wages

Area/Job Title	Number	Base Annual Pay		Cost per Employee		Total Annual Cost
		Salary	Hourly	Burdens	Total	
<u>PROCESS - MILL</u>						
Supervision						
Plant Manager	1	\$138,000		\$41,400	\$179,400	\$179,400
Process General Foreman	1	\$98,901		\$29,670	\$128,571	\$128,571
Shift Foreman*	3	\$92,400		\$27,720	\$120,120	\$360,360
Electrical Supervisor	1	\$98,901		\$29,670	\$128,571	\$128,571
Administrative Technician	1		\$35,446	\$0	\$35,446	\$35,446
Crushing						
Crusher Operator	3		\$35,446	\$14,178	\$49,624	\$148,872
Dozer / Loader Operator	3		\$35,446	\$14,178	\$49,624	\$148,872
Grinding/Leaching/Tailings						
Leach Operator*	3		\$49,903	\$19,961	\$69,864	\$209,593
Reagent / Detox Operator	3		\$35,446	\$14,178	\$49,624	\$148,872
Scrubber Operator	3		\$35,446	\$14,178	\$49,624	\$148,872
Tailings Operator	3		\$35,446	\$14,178	\$49,624	\$148,872
Shift Laborer	3		\$31,433	\$12,573	\$44,006	\$132,017
Recovery Plant						
Carbon Plant Operator*	3		\$49,903	\$19,961	\$69,864	\$209,593
Refinery						
Refiner	2		\$35,446	\$14,178	\$49,624	\$99,248
Refinery Helper	2		\$31,433	\$12,573	\$44,006	\$88,011

Area/Job Title	Number	Base Annual Pay		Cost per Employee		Total Annual Cost
		Salary	Hourly	Burdens	Total	
Process Maintenance						
Mechanic*	3		\$71,786	\$28,714	\$100,500	\$301,500
Shift Mechanic	3		\$39,535	\$15,814	\$55,349	\$166,047
Mechanic Helper	3		\$31,433	\$12,573	\$44,006	\$132,017
Electrician*	2		\$55,660	\$22,264	\$77,925	\$155,849.23
Instrumentation Technician	2		\$39,535	\$15,814	\$55,349	\$110,698
Subtotal Process	48					\$3,181,281
Laboratory						
Chief Metallurgist	1	\$100,000		\$30,000	\$130,000	\$130,000
Fire Assayer	2		\$39,535	\$15,814	\$55,349	\$110,698
Lab Technician	2		\$31,433	\$12,573	\$44,006	\$88,011
Shift Sample Buckers	4		\$31,433	\$12,573	\$44,006	\$176,022
Subtotal Laboratory	9					\$504,731
G&A						
General Manager	1	\$192,000		\$57,600	\$249,600	\$249,600
Purchasing Manager [†]	1	\$93,627		\$28,088	\$121,715	\$121,715
Chief Accountant [†]	1	\$93,627		\$28,088	\$121,715	\$121,715
Accounting Clerk [†]	1		\$62,000	\$24,800	\$86,800	\$86,800
Human Resources/Relations Manager [†]	1	\$93,627		\$28,088	\$121,715	\$121,715
Security/Safety/Training Manager	1	\$75,000		\$22,500	\$97,500	\$97,500
Environmental Supervisor [†]	1	\$110,000		\$33,000	\$143,000	\$143,000
Warehouseman	2		\$43,800	\$17,520	\$61,320	\$122,640
Accounts Payable Clerk [†]	1		\$43,800	\$17,520	\$61,320	\$61,320
Nurse	2		\$43,800	\$17,520	\$61,320	\$122,640
Subtotal G&A	12					\$1,248,645
TOTAL	69					\$4,934,658
TOTAL, \$/t						\$9.57

*Includes additional labor for extended season laborers

[†] Off-site employees

21.7.2.3. Diesel Fuel

Diesel fuel is consumed in the process plant by the carbon regeneration kiln, elution boiler, and the smelting furnace in the refinery. Total consumption of diesel fuel for all process equipment is approximately 449,976 L/a based on process calculations. A local quotation of \$1.30/L is being used.

Diesel fuel will also be required to operate process mobile surface equipment, and the mineral sizer. In the case of the mineral sizer fuel usage is calculated separately. In the case of other mobile equipment fuel costs are included in the hourly operating rates in the cost buildup.

21.7.2.4. *Reagents*

Process reagent and consumables costs have been estimated based upon unit costs and consumptions. Reagent consumptions were developed from test work performed on samples of Tiger Deposit mineralized material, as detailed in Section 13 and from process calculations. Reagent unit costs were primarily provided by Tetra Tech based on recent project experience. Freight costs and applicable taxes are included in the unit prices. Table 21-11 shows the consumption of the major consumables and the unit prices accordingly.

**Table 21-11
Summary of Reagent Costs and Consumption**

Reagent	Annual Consumption	Unit Price
NaCN	367 t	\$4.00/t
Lime	2,375 t	\$0.50/t
Carbon	21,100 kg	\$3.30/kg
Antiscalant	1,440 L	\$2.77/L
Caustic Soda	5,300 kg	\$1.01/kg
Hydrochloric Acid	79 m ³	\$0.47/m ³
Hydrogen Peroxide	62,650 kg	\$1.43/kg
Copper Sulfate	2,190 kg	\$3.15/kg
Fluxes	5,500 kg	\$1.61/kg

21.7.2.5. *Crusher Rolls and Liners*

Crusher rolls, liners and other wear part consumption rates for the primary mineral sizer were developed from inputs by equipment suppliers. Wear and maintenance costs were estimated by KCA based on this information.

21.7.2.6. *Miscellaneous Operating Maintenance Supplies*

Overhaul and maintenance of equipment, along with miscellaneous operating supplies for each area, were based on a unit cost per tonne of material processed. The unit cost for each area was developed from recent KCA projects.

21.7.2.7. *Laboratory*

Fire assaying and solution assaying of samples from both the mine and processing plant areas will be conducted in the on-site laboratory. The actual daily number of samples

processed will vary according to the sampling requirements of the mine but have initially been estimated to average 100 samples per day for each of solids and solution. KCA has assumed a cost of \$5.43/assay and \$1.63/assay for processing solids and solution assays, respectively, based on recent project experience.

21.7.2.8. Mobile Equipment

Numerous pieces of support equipment are required for the processing areas. These include light vehicles, a bulldozer, a Cat 966 loader, a flatbed truck, a 60-ton crane, and a telehandler. The costs to operate and maintain each of these pieces of equipment have been estimated using primarily published information. Otherwise, allowances have been made based upon experience in similar operations.

21.7.3 Process Power

Power usage for the process and process-related infrastructure was derived from estimated connected loads assigned to powered equipment taken from the mechanical equipment list. Equipment power demands under normal operation were assigned and coupled with estimated on-stream times to determine the average energy usage and cost.

The total attached power for the process and infrastructure is estimated at 2.03 MW, with an average draw of 1.16 MW. The total consumed power for these areas is approximately 8.4 kWh/t material processed. Based on the diesel price and estimated fuel consumption of the generators, the power cost has been calculated to be \$0.44/kWh.

21.7.4 General and Administrative

The general and administrative costs include general management, accounting, communications, environmental and social management, human resources, purchasing and procurement, health and safety, security, international travel and camp costs. In most cases, these services represent fixed costs for the site as a whole, with some exceptions such as camp and transportation costs of employees. The G&A costs exclude certain costs such as transport and refining of gold, and environmental rehabilitation costs which are treated as separate line items in the financial model.

The annual budget is estimated at \$3.7 million, including labor, or \$7.11/ t processed.

22.0 ECONOMIC ANALYSIS

22.1 Summary

Based on the estimated production parameters, revenue, capital costs, and operating costs, taxes and royalties, a cash flow model was prepared by KCA for the economic analysis of the Tiger Gold Project. All of the information used in this economic evaluation has been taken from work completed by KCA and other consultants working on the Project, as described in previous sections of this report.

The Tiger Gold Project economics were evaluated using a DCF method, which estimates the NPV of future cash flow streams. The final economic model was developed by KCA, with input from ATAC and Tetra Tech, using the following assumptions:

- Period of analysis of 6 years, including 1 year of pre-production and investment, 4 years of production, and 1 year of reclamation and closure (all closure costs assumed in first year of reclamation and closure for purposes of the PEA);
- Q1 2014 Canadian Dollars;
- Base Case gold price of USD 1,250/oz ;
- Exchange rate of CAD 1 = USD 0.92;
- Year-round mining;
- Seasonal processing for 158 d/a;
- Processing rate of 3,300 t/d;
- Gold recoveries of 87.8% for the heap leach and 91.0% for CIL;
- Capital and operating costs as developed in Section 21 of this report; and
- Closure costs as detailed in Section 20 of this report.

The project economics from the cash flow model based on these criteria are summarized in Table 22-1.

**Table 22-1
Life of Mine Financial Summary**

Financial Analysis	
Internal Rate of Return, Pre-Tax	30.0%
Internal Rate of Return, After-Tax	21.5%
Average Annual Cash Flow, Pre-Tax (millions)	\$41.66
NPV @ 5%, Pre-Tax (millions)	\$52.15
Average Annual Cash Flow, After-Tax (millions)	\$36.24
NPV @ 5%, After-Tax (millions)	\$33.67
Gold Price Assumption (USD/oz)	\$1,250
Silver Price Assumption (USD/oz)	\$19
Payback Period, Pre-Tax (years)	2.2
Payback Period, After-Tax, (years)	2.6
All-in Sustaining Capital Cost* (\$/oz)	\$626
Capital Costs	
Initial Capital, Including Contingency (millions)	\$92.26
Working Capital and Initial Fills (millions)	\$6.10
Mine Sustaining Capital (millions)	\$2.02
Process Sustaining Capital (millions)	\$24.49
Operating Costs (Average LOM)	
Mining, Excluding Pre-Production (\$/t mined)	\$4.46
Process & Support (\$/t processed)	\$20.10
G&A (\$/t processed)	\$7.11
Production Data	
Life of Mine (years)	4
Mine Throughput (Avg. t/d)	3,300
Metallurgical Recovery, Au	89.8%
Average Annual Gold Production (oz)	55,389
Metallurgical Recovery, Ag	19%
Average Annual Silver Production (oz)	15,764
Total Gold Produced, AuEq (oz)	222,516
Average LOM Strip Ratio (waste:ore)	5.58

*As defined by the World Gold Council.

22.2 Methodology

The Tiger Gold Project economics are evaluated using a DCF method. The DCF method requires that annual cash inflows and outflows are calculated, from which the resulting net annual cash flows are estimated and then discounted back to the project evaluation date. Considerations for this analysis include the following:

- The cash flow model was prepared by KCA with input from ATAC and Tetra Tech;
- The period of analysis is 6 years, including 1 year of pre-production and investment, 4 years of production, and 1 year for closure and reclamation (all closure costs assumed in first year of reclamation and closure for purposes of the PEA);
- All cash flow amounts are in Canadian dollars. All costs are considered to be Q1 2014. Inflation is not included in this model;
- As needed, an exchange rate of 0.92 US dollars = 1 Canadian dollar was used;
- The IRR is calculated as the discount rate that yields a NPV of zero;
- The NPV was calculated by discounting the annual cash back to Year -1 at a 5% discount rate, with different discount rates shown for comparison. All annual cash flows are assumed to occur at the end of each respective year;
- The Payback Period is the amount of time, in years, required to recover the pre-production capital costs;
- Working capital is included in the model;
- Government Sales Tax (“GST”) is not included in this model;
- Government royalties and taxes are included in the model;
- 100% equity financing is assumed;
- Reclamation and closure costs are included in the model; and
- Mine production schedule which includes inferred resources.

22.3 General Assumptions

A summary of the general assumptions for cost inputs, parameters, royalties, and taxes used in the economic analysis are as follows.

- The gold pay factor is 99.5%, equal to a refinery deduction of \$6.80 at the base case gold price. An additional refining and transport charge of \$6.00 per ounce is included;
- A gold price of USD 1,250/oz is used as the base case commodity price;
- The life-of-mine average operating costs are CAD 4.46/tonne mined (not including pre-production) for mining, \$20.10/tonne processed for processing, and \$7.11/tonne processed for G&A. Operating costs are detailed in Section 21 of this report;
- The initial capital costs for project construction are incurred in the first year of development (Year -1). Additional costs for mining fleet expansion are included in Year 1. Sustaining costs for the heap leach and tailings pads are included in the year in which they occur. Reclamation and closure costs are also included in the capital estimate. Capital costs are detailed in Section 21 of this report;
- A variable mining royalty (Yukon Quartz Mining Royalty) based on income is included;
- A gold royalty (Yukon Gold Royalty) of \$0.375/oz is included;
- Working capital equal to 60 days of operating cost during the pre-production ramp-up period is included. Initial fills of reagents (cyanide, carbon, etc.) are also included as part of the working capital. The assumption is made that all working capital can be recovered at the project termination, and the effective sum of working capital over the life of mine is thus zero;
- Taxes have been applied, with the following information provided to KCA by ATAC:
 - A Cumulative Capital Cost Allowance (“CCCA”) pool exists for Class 41 depreciable property. This pool is assumed to have zero balance before project initiation, and it is assumed that all major equipment is Class 41. Depreciation is applied to the CCCA pool at a 25% declining balance basis, with the remaining balance is taken in the final year of operation;
 - A Cumulative Canadian Development Expense (“CCDE”) pool exists. This pool is assumed to have zero balance before project initiation, and will receive the EPCM and owner’s cost line items. Up to 30% of the CCDE balance can be claimed each year;
 - A Cumulative Canadian Exploration Expense (“CCEE”) pool exists, with a current balance of \$32.6 million. Up to 100% of this value can be taken in any year.
 - The federal income tax rate of 15% is applied to the estimated taxable income;

- The territorial income tax rate of 15% is applied to the estimated taxable income.
- ATAC has an accumulated Investment Tax Credit (“ITC”) of \$1.2M which can be applied as an income tax credit in any year.
- ATAC has an accumulated Non-capital Loss of \$7.2M which can be applied as a deduction at 100% in any year.

22.3.1 All-in Sustaining Cash Cost

The average cash cost for the life of the mine is calculated by adding all the mining, process and G&A operating costs and dividing that number by the total ounces payable. The total operating costs for the project are \$109.9 million with the total payable ounces at 221,404 ounce; equating to an average cash cost per ounce of \$497/oz. The all-in sustaining costs as defined by the World Gold Council (less corporate G&A), which includes the total operating costs for the project, all sustaining capital costs, royalties, and reclamation and closure costs is \$626.

22.4 Financial Model and Results

A DCF method was used to evaluate the economics of the Tiger Gold Project, and measures the NPV of future cash flow streams. This financial model has been developed by KCA with input from ATAC and their consultants. Table 22-2 shows the key financial parameters derived from the cash flow analysis and Table 22-3 shows the key financial model results. Table 22-4 presents the full cash flow model.

**Table 22-2
Key Financial Parameters**

Parameter	Value	Unit
Au Price	1,250	USD/oz
Ag Price	19	USD/oz
Exchange Rate	0.92	USD/CAD
Au Recovery, Heap	87.8	%
Ag Recovery, Heap	19.0	%
Au Recovery, CIL	91.0	%
Ag Recovery, CIL	19.0	%
Treatment Rate	3,300	t/d
Operating Period	158	d/a
Refining Cost	6	\$/oz
Payable Factor	99.5	%
Federal Tax Rate	15	%
Territorial Tax Rate	15	%

**Table 22-3
Key Financial Model Results**

Pre-Tax NPV	i, %	After-Tax NPV
\$72,675,385	0	\$50,998,189
\$52,147,446	5	\$33,673,501
\$42,145,333	8	\$25,286,492
\$36,265,806	10	\$20,376,951
\$23,850,756	15	\$10,071,595
30.0%	IRR	21.5%
Annual AuEq oz payable	221,404	oz
Mine Life	4	years
Payback	2.6	years
Total Tax & Royalties Paid	\$22,960,639	

**Table 22-4
Cash Flow Analysis**

ITEM	TOTAL	YEAR -1	YEAR 1	YEAR 2	YEAR 3	YEAR 4	YEAR 5
Mine Schedule							
Ore to Process (tonnes)	2,063,422	-	516,200	516,200	515,984	515,038	-
Au Grade (g/t)	3.72	-	5.27	3.21	3.79	2.61	-
Ag Grade (g/t)	5.00	-	5.00	5.00	5.00	5.00	-
Contained Au (oz)	246,855	-	87,472	53,280	62,880	43,223	-
Contained Ag (oz)	331,740	-	82,990	82,990	82,956	82,804	-
Ore Mined (tonnes)	2,063,422	437,645	462,899	231,923	495,054	435,901	-
Waste Mined (tonnes)	11,509,872	1,062,355	3,137,101	3,368,076	3,104,947	837,393	-
Total Mined (tonnes)	13,573,294	1,500,000	3,600,000	3,599,999	3,600,001	1,273,294	-
Strip Ratio (waste:ore)	5.58	2.43	6.78	14.52	6.27	1.92	-
Production							
Ore Processed to Heap Leach (tonnes)	866,637	-	216,804	216,804	216,713	216,316	-
Ore Processed to CIL (tonnes)	1,196,785	-	299,396	299,396	299,271	298,722	-
Au grade to Heap Leach (g/t)	3.45	-	4.89	2.98	3.52	2.42	-
Ag grade to Heap Leach (g/t)	3.93	-	3.93	3.93	3.93	3.93	-
Au grade to CIL (g/t)	3.91	-	5.54	3.38	3.99	2.75	-
Ag grade to CIL (g/t)	5.78	-	5.78	5.78	5.78	5.78	-
Total Ore Processed (tonnes)	2,063,422	-	516,200	516,200	515,984	515,038	-
Contained Au (oz)	246,855	-	87,472	53,280	62,880	43,223	-
Contained Ag (oz)	331,879	-	83,025	83,025	82,990	82,838	-
Recoverable Gold, Heap (oz)	84,528	-	29,952	18,244	21,531	14,801	-
Recoverable Gold, CIL, (oz)	137,029	-	48,556	29,576	34,905	23,993	-
Total Recoverable Gold (oz)	221,558	-	78,508	47,820	56,436	38,794	-
Recoverable Silver, Heap (oz)	20,800	-	5,203	5,203	5,201	5,192	-
Recoverable Silver, CIL (oz)	42,257	-	10,571	10,571	10,567	10,548	-
Total Recoverable Silver (oz)	63,057	-	15,775	15,775	15,768	15,739	-
Total Equivalent Gold Produced (AuEq oz)	222,516	-	78,747	48,059	56,676	39,033	-
Payable Gold (oz)	220,450	-	78,115	47,581	56,154	38,600	-
Payable Silver (oz)	62,742	-	15,696	15,696	15,689	15,661	-
Payable Equivalent Gold (AuEq oz)	221,404	-	78,354	47,819	56,393	38,838	-
Refining Charge	\$1,328,422	-	\$470,123	\$286,915	\$338,356	\$233,028	-
Net Revenue	\$299,491,675	-	\$105,988,789	\$64,684,786	\$76,282,135	\$52,535,965	-

ITEM	TOTAL	YEAR -1	YEAR 1	YEAR 2	YEAR 3	YEAR 4	YEAR 5	
Operating Costs								
Mining Cost	\$4.46/t	\$53,791,322	-	\$15,795,785	\$15,994,497	\$15,084,494	\$6,916,545	-
Processing Cost	\$20.10/t	\$41,483,215	-	\$10,377,729	\$10,377,729	\$10,373,387	\$10,354,369	-
G&A Cost	\$7.11/t	\$14,669,857	-	\$3,669,913	\$3,669,913	\$3,668,378	\$3,661,652	-
Total Operating Costs		\$109,944,393	-	\$29,843,428	\$30,042,140	\$29,126,259	\$20,932,566	-
Operating Cash Flow								
		\$189,547,282	-	\$76,145,360.69	\$34,642,646	\$47,155,876	\$31,603,399	-
Capital Costs								
Mine Equipment		\$22,282,414	\$20,601,487	\$1,680,927	-	-	-	-
Earthworks & Liner (Supply & Install)		\$26,102,774	\$5,693,638	\$6,582,069	\$6,456,871	\$7,225,619	\$144,578	-
Civils (Supply & Install)		\$907,609	\$907,609	-	-	-	-	-
Structural Steel (Supply & Install)		\$239,565	\$239,565	-	-	-	-	-
Platework (Supply & Install)		\$1,107,818	\$1,107,818	-	-	-	-	-
Mechanical Equipment (Supply)		\$25,374,219	\$25,374,219	-	-	-	-	-
Mechanical Equipment (Install)		\$4,830,450	\$4,830,450	-	-	-	-	-
Piping (Supply & Install)		\$2,090,402	\$2,090,402	-	-	-	-	-
Electrical (Supply)		\$2,660,185	\$2,660,185	-	-	-	-	-
Electrical (Install)		\$616,435	\$616,435	-	-	-	-	-
Instrumentation (Supply & Install)		\$1,611,644	\$1,611,644	-	-	-	-	-
Infrastructure (Supply & Install)		\$1,717,748	\$1,717,748	-	-	-	-	-
Spare Parts		\$905,781	\$905,781	-	-	-	-	-
Contingency	20%	\$15,991,628	\$11,573,616	\$1,652,599	\$1,291,374	\$1,445,124	\$28,916	-
EPCM		\$7,449,857	\$7,449,857	-	-	-	-	-
Indirect Costs (Including Contingency)		\$4,880,400	\$4,880,400	-	-	-	-	-
Subtotal		\$118,768,929	\$92,260,853	\$9,915,595	\$7,748,245	\$8,670,743	\$173,494	-
Initial Fills		\$712,501	\$712,501	-	-	-	-	-
Working Capital (60 Days)		\$5,388,286	-	\$5,388,286	-	-	-	-
Less: Working Capital Recovery		\$5,388,286	-	-	-	-	\$5,388,286	-
Subtotal		\$119,481,430	\$92,973,354	\$15,303,881	\$7,748,245	\$8,670,743	-\$5,214,793	-
Reclamation & Closure		\$2,012,500	-	-	-	-	-	\$2,012,500
Closure Bonding		-	\$1,006,250	\$503,125	\$503,125	-	-	-\$2,012,500
Less: Salvage		\$4,705,476	-	-	-	-	\$4,705,476	-
Total Capital Costs		\$116,788,454	\$93,979,604	\$15,807,006	\$8,251,370	\$8,670,743	-\$9,920,269	-
Pre-Tax Net Cash Flow								
22.4.1 Pre-tax net cash flow (before royalty)		\$72,758,829	-\$93,979,604	\$60,338,355	\$26,391,276	\$38,485,133	\$41,523,668	-
Less: Gold Royalty		\$83,444	-	\$29,530	\$18,022	\$21,254	\$14,637	-
Pre-tax Net Cash Flow		\$72,675,385	-\$93,979,604	\$60,308,825	\$26,373,254	\$38,463,880	\$41,509,031	-
Cumulative Pre-Tax Net Cash Flow		\$72,675,385	-\$93,979,604	-\$33,670,779	-\$7,297,525	\$31,166,354	\$72,675,385	\$72,675,385

ITEM	TOTAL	YEAR -1	YEAR 1	YEAR 2	YEAR 3	YEAR 4	YEAR 5
Income Tax Calculations							
CCA (Capital Depreciation) - Declining Balance (25%)							
Balance Start of the Year		-	\$75,477,259	\$65,284,089	\$55,742,781	\$49,393,986	\$37,197,296
Additions	\$64,788,038	\$75,477,259	\$9,915,595	\$7,748,245	\$8,670,743	\$173,494	-
CCA Claimed	\$101,811,841	-	\$20,108,764	\$17,289,553	\$15,019,538	\$49,393,986	-
CDE (Development Expense) - Declining Balance (30%)							
Balance Start of the Year	-	-	\$12,330,257	\$8,631,180	\$6,041,826	\$4,229,278	\$2,960,495
Additions	\$12,330,257	\$12,330,257	-	-	-	-	-
CDE Claimed	\$9,369,762	-	\$3,699,077	\$2,589,354	\$1,812,548	\$1,268,783	-
Revenue	\$299,491,675		\$105,988,789	\$64,684,786	\$76,282,135	\$52,535,965	-
(+) Investment Tax Credit	\$1,200,000	-	-	\$1,200,000	-	-	-
(-) Royalties	\$8,458,791	-	\$4,969,049	\$909,586	\$1,881,917	\$698,239	-
(-) Operating Costs	\$109,944,393	-	\$29,843,428	\$30,042,140	\$29,126,259	\$20,932,566	-
(-) Reclamation	\$2,012,500	\$1,006,250	\$503,125	\$503,125	-	-	-
EBIDTA	\$181,282,241	-	\$70,673,187	\$34,429,935	\$45,273,959	\$30,905,161	-
(-) CCA	\$101,811,841	-	\$20,108,764	\$17,289,553	\$15,019,538	\$49,393,986	-
(-) CEE	\$32,600,000	-	\$32,600,000	-	-	-	-
(-) CDE	\$9,369,762	-	\$3,699,077	\$2,589,354	\$1,812,548	\$1,268,783	-
(-) Non-Capital Loss	\$8,918,751	-	\$8,918,751	-	-	-	-
Taxable Income	\$48,339,496	-	\$5,346,595	\$14,551,028	\$28,441,873	-\$19,757,609	-
Federal Income Tax	15.0%	-	\$801,989	\$2,182,654	\$4,266,281	-	-
Provincial Income Tax	15.0%	-	\$801,989	\$2,182,654	\$4,266,281	-	-
Mining Royalty Calculations							
Depreciation Pool - Straight Line (15%)							
Year 1 Basis	-	62,030,307	71,945,902	71,945,902	71,945,902	71,945,902	-
Year 2 Basis	-	-	-	7,748,245	7,748,245	7,748,245	-
Year 3 Basis	-	-	-	-	8,670,743	8,670,743	-
Year 4 Basis	-	-	-	-	-	173,494	-
Depreciation Amount	\$47,980,887	-	10,791,885	11,954,122	11,954,122	13,280,757	-
Development Pool (amortized based on reserves consumed)							
Resource Usage (oz AuEq)	222,516	-	78,747	48,059	56,676	39,033	-
Development Amount	\$34,911,386	-	\$12,354,986	\$7,540,228	\$8,892,117	\$6,124,055	-
Value of minerals (Part 3)	\$299,491,675	-	\$105,988,789	\$64,684,786	\$76,282,135	\$52,535,965	-
(-) Deductions (Part 4)	\$109,944,393	-	\$29,843,428	\$30,042,140	\$29,126,259	\$20,932,566	-
(-) Development Allowance (Part 5)	\$34,911,386	-	\$12,354,986	\$7,540,228	\$8,892,117	\$6,124,055	-
(-) Depreciation Allowance (Part 6)	\$47,980,887	-	\$10,791,885	\$11,954,122	\$11,954,122	\$13,280,757	-
Income Subject to Royalty	\$106,655,010	-	\$52,998,489	\$15,148,296	\$26,309,637	\$12,198,587	-
Royalty Payable	\$8,375,347	-	\$4,939,519	\$891,564	\$1,860,664	\$683,601	-
After-Tax Net Cash Flow							
Pre-Tax Net Cash Flow	\$72,675,385	-\$93,979,604	\$60,308,825	\$26,373,254	\$38,463,880	\$41,509,031	-
Income Tax Payable	\$14,501,849	-	\$1,603,978	\$4,365,308	\$8,532,562	-	-
Investment Tax Credit	-\$1,200,000	-	-\$1,200,000	-	-	-	-
Mining Royalty	\$8,375,347	-	\$4,939,519	\$891,564	\$1,860,664	\$683,601	-
After-Tax Net Cash Flow	\$50,998,189	-\$93,979,604	\$54,965,328	\$21,116,382	\$28,070,654	\$40,825,429	-
Cumulative After-Tax Net Cash Flow	\$50,998,189	-\$93,979,604	-\$39,014,277	-\$17,897,895	\$10,172,760	\$50,998,189	\$50,998,189

22.5 Sensitivity Analysis

Sensitivity of project economics to key parameters including gold price, total capital cost (including reclamation, closure and salvage) and average operating cost has been prepared. The pre-tax sensitivity analysis is presented in Table 22-5, and graphically in Figures 22-1, 22-2, 22-3 & 22-4. Table 22-6 presents the after-tax variation in IRR and NPV based on gold price. The economic indicators chosen for sensitivity evaluation are the IRR, and NPV at 0%, 5% and 8% discount rates. The payback period in years is also presented based on gold price.

**Table 22-5
Sensitivity Analysis (Pre-Tax)**

Variation		IRR	NPV			Payback
			0%	5%	8%	Years
Gold Price (USD/oz)						
	USD 1,100.00	15.5%	\$36,731,635	\$21,429,853	\$14,054,316	2.9
	USD 1,250.00	30.0%	\$72,675,385	\$52,147,446	\$42,145,333	2.2
	USD 1,350.00	39.5%	\$96,637,783	\$72,625,755	\$60,872,599	1.8
	USD 1,500.00	53.5%	\$132,581,267	\$103,343,123	\$88,963,412	1.3
Capital Cost (% of Base Case)						
80%	\$93,958,143	48.0%	\$95,505,695	\$73,547,123	\$62,771,384	N/A
90%	\$105,373,298	38.1%	\$84,090,540	\$62,847,284	\$52,458,358	N/A
100%	\$116,788,454	30.0%	\$72,675,385	\$52,147,446	\$42,145,333	N/A
110%	\$128,203,609	23.3%	\$61,260,230	\$41,447,608	\$31,832,307	N/A
120%	\$139,618,764	17.6%	\$49,845,075	\$30,747,769	\$21,519,281	N/A
Average Operating Cost (% of Base Case)						
80%	\$70,364,412	44.9%	\$112,255,367	\$85,765,635	\$72,777,506	N/A
90%	\$89,054,959	38.0%	\$93,564,820	\$69,890,379	\$58,312,313	N/A
100%	\$109,944,393	30.0%	\$72,675,385	\$52,147,446	\$42,145,333	N/A
110%	\$133,032,716	21.0%	\$49,587,062	\$32,536,836	\$24,276,565	N/A
120%	\$158,319,926	10.6%	\$24,299,852	\$11,058,549	\$4,706,009	N/A

**Table 22-6
After-Tax Variation Based On Gold Price**

Variation		IRR	NPV			Payback
			0%	Years	8%	Years
Gold Price (USD/oz)						
	USD 1,100.00	11.2%	\$26,347,824	\$12,606,132	\$6,015,968	3.2
	USD 1,250.00	21.5%	\$50,998,189	\$33,673,501	\$25,286,492	2.6
	USD 1,350.00	27.9%	\$67,273,695	\$47,489,069	\$37,873,240	2.3
	USD 1,500.00	37.2%	\$91,460,726	\$68,026,015	\$56,586,562	1.9

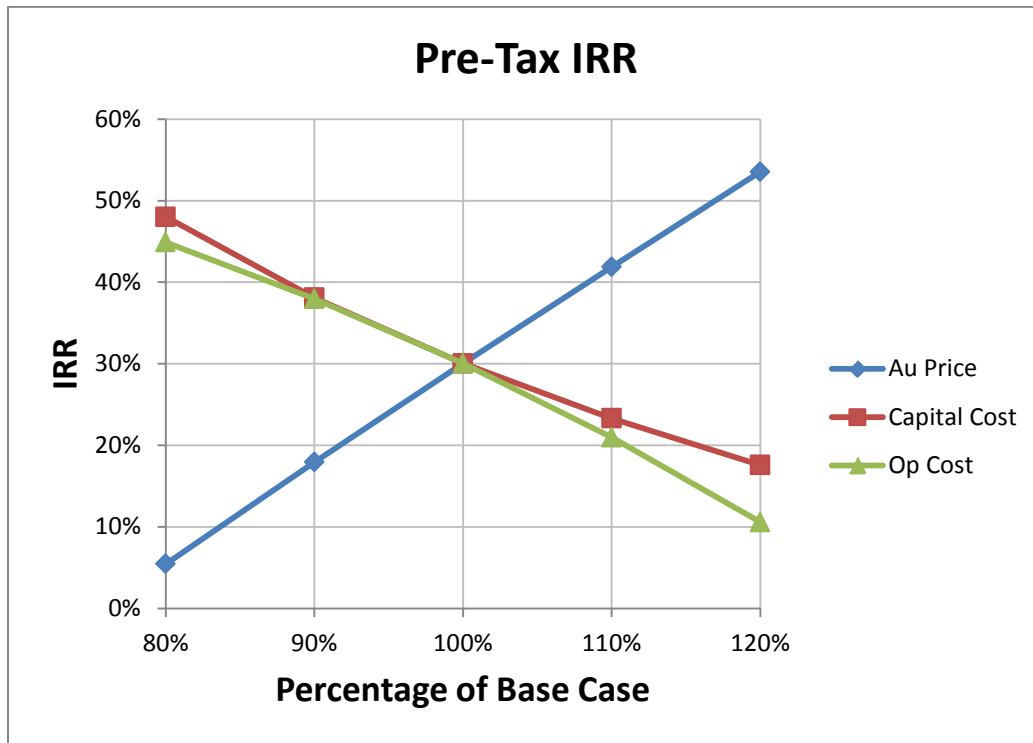

Figure 22-1
Pre-Tax IRR vs. Gold Price, Capital Cost, and Operating Cash Cost

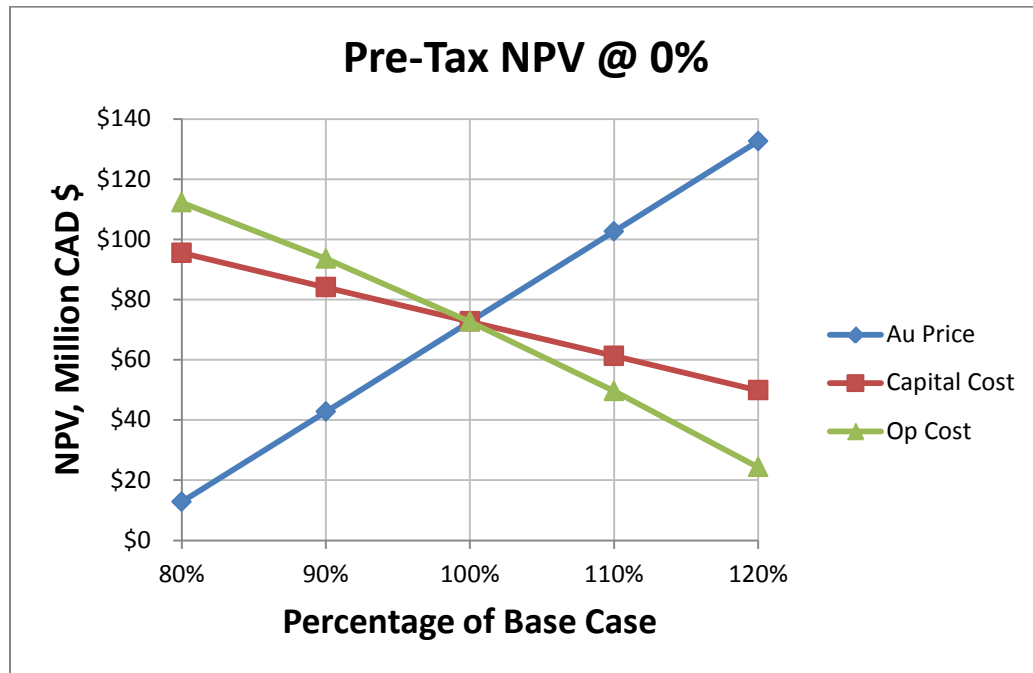

Figure 22-2
NPV @ 0% vs. Gold Price, Capital Cost, and Operating Cash Cost

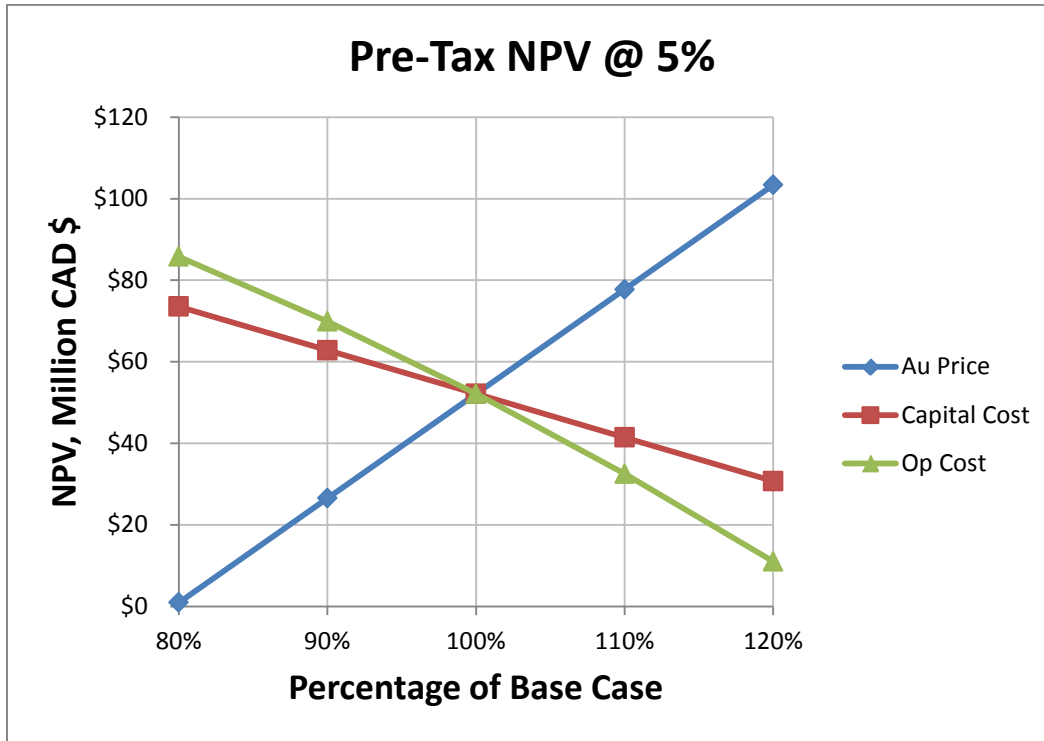

Figure 22-3

NPV @ 5% vs. Gold Price, Capital Cost, and Operating Cash Cost

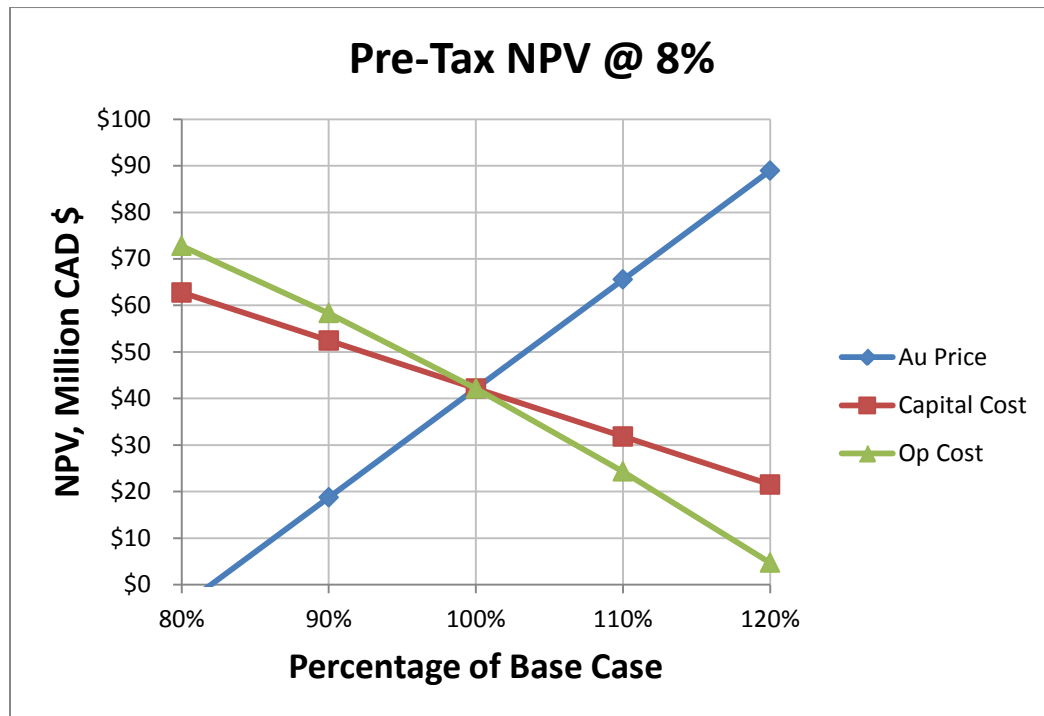

Figure 22-4

NPV @ 8% vs. Gold Price, Capital Cost, and Operating Cash Cost

23.0 ADJACENT PROPERTIES

Strategic Metals Ltd. (“Strategic”) holds claims adjacent to the Property. Strategic’s Staff property adjoins the Property on its southwestern boundary, while their Rod property adjoins the southeastern portion of the Property. Both are part of Strategic’s Midas Touch project. Strategic has carried out a number of prospecting and sampling programs on both properties through the period 2011 to 2013 and drilled at the Rod property in 2011 (W.D. Eaton, pers. com., 2014).

24.0 OTHER RELEVANT DATA AND INFORMATION

The Authors are unaware of any additional information or data relevant to the Tiger Gold Project or the Rau Property that would require disclosure for PEA purposes.

25.0 INTERPRETATION AND CONCLUSIONS

Results of this study indicate that the Tiger Gold Project as conceptualized herein has merit and appears to be an economically attractive project. As such, further development is justified.

In summary, the project as envisioned will be an open pit mine that will utilize a conventional truck-and-excavator fleet. The Tiger Gold Project's total mine life is 5 years, including 1 year of pre-stripping followed by 4 years of production. Closure and reclamation activities will take 2 years, with all costs modeled in the first year of closure for purposes of the PEA. Over the 5 years mine life, the pit will produce 2 million tonnes of mineralized material and 11.5 million tonnes of waste rock. The LOM average gold grade is 3.72 g/t. The LOM stripping ratio is 5.58. Payable gold produced is 221,000 ounces during the life of the project.

Factors which may affect the mine plan include changes to the geotechnical parameters, gold price, exchange rate, operating costs, marketing assumptions and metallurgical recoveries.

The metallurgical testing has indicated that the oxide material is amenable to cyanide leaching; however, high cement additions are required for conventional agglomeration and heap leaching due to the high clay content. Due to the relatively small size of the resource, conventional milling results in marginal project economics. To maximize economics, a hybrid processing option was used for this study, where the fine material is treated in a small CIL circuit and the coarse material is treated by conventional heap leaching.

Based on this PEA, the LOM capital expenditures required for the hybrid process is \$124.9 million including \$93 million for pre-production and \$5.4 million in working capital. The average annual operating cost for the process is \$20.10/t material processed and \$7.11/t for G&A. The mining cost (not including capitalized pre-production) is \$4.46/t mined. The Project is projected to produce 221,400 payable ounces of gold at a total all-in sustaining cash cost (as defined by the World Gold Council, less corporate G&A) of \$ 626/oz. The pre-tax IRR is 30.0%.

26.0 RECOMMENDATIONS

Based on the results of the PEA, KCA recommends the following future work:

- The Project should proceed to the prefeasibility level;
- Additional studies on site infrastructure, including water systems, water sources, and site access;
- Optimization of the power systems with respect to attached loads and power distribution;
- Further optimization of labor, shift schedules, man camp, and light vehicles to refine the operating cost estimates;
- Further studies on reagent purchasing and logistics;
- Confirmatory metallurgical testwork, particularly with respect to: the mass and grade split between the fine and coarse material, leach retention times for the CIL and heap, cyanide destruction, and heap rinsing;
- Tests to determine the crushing work index and abrasion index should be performed on the material to better estimate wear and maintenance for crushing equipment;
- Tests for slurry rheology and flocculent requirements should be performed;
- Additional studies may be beneficial to evaluate other mining rates, mine life, or possible year round operation;
- Additional geotechnical site investigations for the leach pad and plant areas; and
- An investigation of extending the existing power line from the Keno Hill area should be performed.

The estimated cost for the additional metallurgical work and infrastructure development studies will be approximately \$600,000.

For mining, Tetra Tech makes the following recommendations for future work:

- The project should proceed to the prefeasibility level. A detailed mining production schedule and design should be developed with detailed mining activities to understand the potential constraints and cost reduction opportunities;
- As the pit optimization and scheduling results are highly dependent on the geotechnical parameters, more detailed geotechnical studies and/or fieldwork should be conducted to better define the appropriate pit slope angles and design parameters for the pit, stockpile and waste dump;
- To estimate pit dewatering requirements, a hydrogeological study should be completed;

- A detailed characterization of mine waste material should be completed to enhance the waste management design; and
- A trade-off study between owner and contract mining is recommended. Given the short life time, leasing of a mining fleet could also enhance the project economics.

The estimated cost for the proposed mining work will be approximately \$375,000.

For environmental work, Resource Strategies Inc. makes the following recommendations:

- Continue monthly hydrology monitoring program with the addition of flow measurements to provide data necessary for metal loading calculations;
- A subsurface hydrological investigation should be undertaken prior to future stages of study. In this investigation data will be collected and analyzed to provide an accurate characterization of groundwater depth, flow and quality to be potentially affected by the pit, leach pad, and tailings areas;
- Ensure wildlife reports from ongoing work are completed. Wildlife gaps yet to be reported include wolverine, pika, raptors, waterfowl, as well as a bear denning survey;
- Ensure completion of a rare plant assessment study currently in progress;
- Once the final mine plan / project footprint is determined, a Heritage Resource Impact Assessment must be conducted to determine if any heritage conflicts exist;
- Geochemical characterization of all representative lithologies should be commenced prior to future study. Static ABA should suffice to commence assessment under YESAA. Kinetic ABA may be required for water licensing if identified during preliminary assessment;
- Geochemical characterization of borrow sources and overburden stripping areas will also be required;
- Develop a detailed management plan for the proposed operation for the following:
 - Vegetation, Wildlife, and Fish and Fish Habitat management plans. The Fish and Fish Habitat Management Plan should include habitat impact mitigation and compensation plans that satisfy section 35(2) of the Fisheries Act (if necessary);
 - Access Road Management Plan, including traffic management and safety on access road and construction site, and maintenance of roads;
 - ML/ARD Prediction and Prevention and Waste Rock and Tailings management plans;
 - Management plans for water, air emissions and fugitive dust, noise, and soil;

- Hazardous goods storage and domestic and industrial solid waste management plans;
- Erosion control and sediment control plan;
- Spill contingency and emergency response plan;
- Airport and aircraft management plan;
- Archaeological and heritage site protection plan; and
- Construction plan, including provision for environmental supervision.
- A detailed decommissioning and reclamation plan will be required; and
- Documentation of formalized socioeconomic consultation is a requirement for YESAB submissions at the Executive Committee level. ATAC will also need to negotiate an enhanced agreement (Impacts Benefit Agreement) with the impacted First Nations, encompassing production.

The estimated cost for the proposed environmental work will be approximately \$500,000.

Giroux Consultants Ltd. makes the following recommendations for future work:

A program of trenching, auger drilling and core drilling is recommended to add to the current resource base and to upgrade inferred resources into the indicated category. Core drilling was not carried out in areas where the oxide mineralization is exposed on surface due to the difficulty encountered in collaring within the loose material and subsequent very poor core recovery through the mineralized zone. As a consequence, much of this material is not included in the resource. To remedy this situation, a program of 950 meters of trenching and channel sampling and 22 auger holes on 14 sections through the mineralized zone, from section 10+075 to 10+425, is recommended, at an estimated cost of \$70,000. Proposed trench and auger hole locations are shown in in Table 26-1.

Recommended core drilling includes 9 shallow drill holes for a total of 490 meters to provide better definition of Tiger Deposit mineralization at an estimated budget of \$269,500.

Table 26-1
Proposed Tiger Deposit Auger Holes and Trenching

Section	No. Auger Holes	Trenching (m)
10+425	2	50
10+400	1	50
10+375	1	50
10+350	1	50
10+325	1	75
10+300	1	50
10+275	1	50
10+250	2	75
10+200	3	50
10+175	1	100
10+150	2	50
10+125	3	100
10+100	1	100
10+075	2	100
Total	22	950

Table 26-2
Proposed Tiger Deposit Core Drill Holes

Section	Level Plan	Angle	Depth (m)
10+375	1350	-70	65
10+325	1325	-60	75
10+275	1325	-60	35
10+225	1300	-60	50
10+225	1300	-60	30
10+175	1275	-60	55
10+175	1275	-60	70
10+175	1275	-60	60
10+150	1275	-60	50
Total			490

A summary of estimated future study costs to advance the Tiger Gold Project to a pre-feasibility level are summarized in Table 26-3 below.

Table 26-3
Summary of Estimated Costs for Next Level of Study (PFS)

Task	Cost
Metallurgical tests, scrubbing, CIL, column tests, thickener tests, work indexes, abrasion, rinsing, cyanide destruction	\$200,000
Designs & studies, plant	\$200,000
Designs & studies, infrastructure	\$200,000
Hydrology studies	\$75,000
Waste characterization	\$100,000
Geotechnical studies	\$50,000
Mining studies	\$150,000
Flora / fauna / heritage studies	\$100,000
Geochemical characterization	\$100,000
Management plan preparation	\$100,000
Closure plan preparation	\$100,000
Social agreements advance	\$100,000
Additional drilling	\$339,500
Total	\$1,814,500

27.0 REFERENCES

- Abbott, G. (1990). Geology Map of Mount Westman Map Area (106D/1); Indian and Northern Affairs Canada, Exploration and Geological Services Division, Yukon Region, Open File 1990-1.
- ATAC Resources Ltd. (2011). News Release dated Sept. 13, 2011, available on SEDAR.
- Blusson, S.L. (1978). Regional geological setting of lead-zinc deposits in Selwyn Basin, Yukon; Current Research, Part A, Geological Survey of Canada, Paper 78-1a, pp 77-80.
- Carlyle, L.W. (1989). Assessment Report on the TAF Claims; prepared for Bonventures Ltd.
- Cathro, R.J. (1989). Report on Geochemical Sampling at the Now Property, Yukon; prepared for NDU Resources Ltd.
- Cathro, R.C. (2006). Great Mining Camps of Canada 1: The History and Geology of the Keno Hill Silver Camp, Yukon Territory; Geoscience Canada, Vol. 33, No. 3, pp 103-134.
- Cockfield, W.E. (1925). Canada Department of Mines; Summary Report, 1924, Part A; Upper Beaver River Area, Mayo District.
- Churchill, S. (1980). Bluelite Assessment Report; Assessment Report filed on behalf of Prism Joint Venture, p. 20.
- Dewonck, B. (1980). Assessment Report for Dee Claims 1 – 174; prepared for Prism Resources Limited.
- Deklerk, R. and Traynor, S. (compilers). (2004). Yukon MINFILE 2004 - A database of mineral occurrences; Yukon Geological Survey, CD-ROM.
- Dumala, M. (2008). Assessment Report Describing Prospecting and Diamond Drilling at the Wau Property; prepared for Yankee Hat Minerals Ltd. and ATAC Resources Ltd.
- Dumala, M. (2009). Assessment Report Describing Geological Mapping, Prospecting, Soil Geochemistry, Diamond Drilling and Geophysical Surveys at the Rau Property; prepared for ATAC Resources Ltd.
- Dumala, M. and Lane, J. (2010). Assessment Report Describing Geological Mapping, Prospecting, Soil Geochemistry and Diamond Drilling at the Rau Property; prepared for ATAC Resources Ltd.
- Eaton, W.D. and Panton, B. (2008). Assessment Report Describing Geological Mapping, Prospecting, Soil Geochemistry and Geophysical Surveys at the Rau Property; prepared for ATAC Resources Ltd.

- Fingler, J. (2005). Private geological report on the McQuesten Property for Alexco Resources Corp; published in Alexco prospectus, available from (http://www.sedar.com/issuers/issuers_en.htm).
- Golder Associates. (2014). Private geotechnical report on the Tiger Deposit for ATAC Resources Ltd.
- Green, L.C. (1972). Geology of Nash Creek, Larsen and Dawson Map Areas, Yukon Territory; Geological Survey of Canada, Memoir 364, pp 157.
- Hilker, R.G. (1969). Property Evaluation Report on the Jet Claim Group; Prepared for Mr. P. Verslucé.
- Hornbrook, E.H.W., Friske, P.W.B., Lynch, J.J., McCurdy, M.W., Gross, H., Galletta, A.C. and Durham, C.C. (1990). National Geochemical Reconnaissance Stream Sediment and Water Geochemical Data, East Central Yukon (106D, parts of 106C, 106E and 106F); GSC Open File 2175.
- InfoMine USA. (2013). Mine and Mill Equipment Costs – An Estimator’s Guide [2013].
- Johnson, A. A. and Richardson, J. (1969a). Geological and Geochemical Report on the Beaver A Group and Beaver B Group of Mineral Claims.
- Johnson, A. A. and Richardson, J. (1969b). Geochemical Report on the Won “A” Group of Mineral Claims
- Kingston, S.P. (2009). Nature and Origin of Gold-Rich Carbonate Replacement Deposits at the Rau Occurrence, Central Yukon; A Thesis Submitted in Partial Fulfillment of the Requirements for the Degree of Bachelor of Science (Honours) in the Faculty of Science, University of British Columbia.
- Kingston, S., Mortensen, J., Dumala, M. and Gabites, J. (2010). Ar-Ar Geochronology and Pb Isotopic Constraints on the Origin of the Rau Gold-Rich Carbonate Replacement Deposit, Central Yukon; In Yukon Exploration and Geology 2009., Yukon Geological Survey, pp 213-222.
- Montgomery, J.H and Cavey, G. (1978). Assessment Report for El 1-70 Claims, prepared for Prism Resources Limited.
- Montgomery, J.H. and Dewonck, B. (1977). Assessment Report for Dee Claims 1-48; prepared for Prism Resources Limited.
- Montgomery, J.H and Dewonck B. (1978). Assessment Report for Dee Claims 1-48; prepared for Prism Resources Limited.
- Mortensen, J.K., Hart, C.J.R., Murphy, D.C. and Heffernan, S. (2000). Temporal Evolution of Early and Mid-Cretaceous Magmatism in the Tintina Gold Belt; Concepts, Exploration, and Discoveries, Special Volume 2, British Columbia and Yukon Chamber of Mines, January 2000, pp 49-57.
- Panton, B.S. (2008). A Deposit Model for Mineralization at the Rau Property, Yukon Territory; A Thesis Submitted in Partial Fulfillment of the Requirements for a Degree of Bachelor of Applied Science in the Faculty of Applied Science, Geological Engineering Program, University of British Columbia.

- Prism Joint Venture. (1979a). Assessment Report for Dee Claims 1 – 174; prepared for Prism Resources Limited.
- Prism Joint Venture. (1979b). Assessment Report for Kathy Claims 1 – 8; prepared for Prism Resources Limited.
- Roots, C. (1990). Geology of 106D/8 and 106D/7 (East half) Map Areas; Indian and Northern Affairs Canada, Exploration and Geology Services Division, Yukon Region, Open File 1990-3.
- Seigel, H. O., Nind, C., Macqueen, J., Chouteau, M., and Giroux, B. (2009). “Results from the first field trial of a borehole gravity meter”, Paper presented at ASEG’s 20th International Geophysical Conference held in Adelaide in February 2009.
- Sinclair, A.J. (1976). “Applications of Probability Graphs in Mineral Exploration”, The Association of Exploration Geochemists Special Volume No. 4, 1976. 95 pp.
- Sinclair, A.J. and Bentzen, A. (1993). “P-Res Version 2.0 A computer program to aid in the interpretation of polymetallic assay, geochemical, environmental and quality control data”, Department of Earth and Ocean Sciences, UBC.
- Sivertz, G. (1979). Assessment Report: Geology of the Silver Hawk Claims; prepared for Prism Resources Limited.
- Sivertz, G. (1980). Assessment Report: Geology of the Silver Hawk Claims; prepared for Prism Resources Limited.
- Yukon Geological Survey. (2011). Geoprocess File – Summary Report; Nash Creek Map Area – N.T.S. 106D. Retrieved July 29, 2014 from:
http://emrlibrary.gov.yk.ca/ygs/open_files/2002/2002_8d/documents/map_specific/106d.pdf
- Yukon Community Profiles. Retrieved July 29, 2014 from:
<http://www.yukoncommunities.yk.ca>

28.0 DATE AND SIGNATURE PAGE

This report, entitled Preliminary Economic Assessment (PEA) NI43-101 Technical Report on the Tiger Gold Project, Yukon Territory, Canada has the following report dates:

Report Date is: 04 September, 2014

The Effective Date of the PEA is: 23 July, 2014

The report was prepared and signed by the following authors:

[Original Signed] _____ Date: _____
Daniel Kappes, P. Eng.

[Original Signed] _____ Date: _____
Gary H. Giroux, P. Eng.

Original Signed] _____ Date: _____
Sabry Hafez, Ph.D., P. Eng.

[Original Signed] _____ Date: _____
Robert L. McIntyre, R.E.T.

[Original Signed] _____ Date: _____
Gerald Carlson, Ph.D., P.Eng



Kappes, Cassidy & Associates

DANIEL W. KAPPES, P.E.

I, Daniel W. Kappes, P.E., as an author of this report entitled "Preliminary Economic Assessment (PEA) NI 43-101 Technical Report on the Tiger Gold Project, Yukon Territory, Canada", prepared for ATAC Resources Ltd., effective as of July 23, 2014 and dated September 4, 2014, do hereby certify that:

1. I am President of the firm of Kappes, Cassidy & Associates at 7950 Security Circle, Reno, Nevada USA 89506.
2. I am a graduate of the Colorado School of Mines (1966) and the University of Nevada, Mackay School of Mines (1972), and hold B. Sc. and M. Sc. degrees in Mining Engineering.
3. I am a Professional Mining and Metallurgical Engineer (No. 3223) in the State of Nevada, USA, registered through the Nevada State Board of Professional Engineers and Land Surveyors. I have practiced my profession continuously since 1966. I am a "Qualified Person" for the purposes of NI 43-101 by reason of my education, affiliation with a professional association as defined by NI 43-101 and past relevant work experience.
4. I have read the definition of "qualified person" set out in National Instrument 43-101 (NI 43-101) and certify that by reason of my education, affiliation with a professional association (as defined in NI 43-101) and past relevant work experience, I fulfill the requirements to be a "qualified person" for the purposes of NI 43-101.
5. I have visited the Tiger Project Property.
6. I am one of the authors of this Technical Report, responsible for preparation of Sections 2, 3, 13, 17, 18, 19, and 22, and Section 21 in relation to process capital and operating costs, and relevant portions of Sections 1, 25, and 26 related to processing.
7. I am independent of the Issuer applying the test set out in Section 1.5 of NI 43-101.
8. I have not had prior involvement with the property that is the subject of the Technical Report.
9. I have read NI 43-101, and the Technical Report has been prepared in compliance with NI 43-101 and Form 43-101F1.
10. To the best of my knowledge, information, and belief, the Technical Report contains all scientific and technical information that is required to be disclosed to make the Technical Report not misleading.

Dated this 4th day of September, 2014

Original signed by

Daniel W. Kappes

Daniel W. Kappes, P.E.
Kappes, Cassidy & Associates
7950 Security Circle
Reno, NV 89506-19

CERTIFICATE G.H. Giroux

I, G.H. Giroux, of 982 Broadview Drive, North Vancouver, British Columbia, do hereby certify that:

- 1) I am a consulting geological engineer with an office at #1215 - 675 West Hastings Street, Vancouver, British Columbia.
- 2) I am a graduate of the University of British Columbia in 1970 with a B.A. Sc. and in 1984 with a M.A. Sc., both in Geological Engineering.
- 3) I am a member in good standing of the Association of Professional Engineers and Geoscientists of the Province of British Columbia.
- 4) I have practiced my profession continuously since 1970. I have had over 30 years' experience calculating mineral resources. I have previously completed resource estimations on a wide variety of precious metal deposits both in B.C. and around the world, including carbonate hosted deposits at Ketzka River and Mickle Mine.
- 5) I have read the definition of "qualified person" set out in National Instrument 43-101 and certify that by reason of education, experience, independence and affiliation with a professional association, I meet the requirements of an Independent Qualified Person as defined in National Instrument 43-101.
- 6) I am responsible for the preparation of Section 14 of the technical report titled **"Preliminary Economic Assessment (PEA) NI 43-101 Technical Report on the Tiger Gold Project Yukon Territory, Canada"** dated September 5, 2014 (the "Technical Report"). I have visited the property on Sept. 7th -9th 2009 and August 30-31st, 2011.
- 7) I have previously completed a resource estimate on this deposit in November 2011 from which this reports resource information is taken.
- 8) As of the date of this certificate, to the best of my knowledge, information and belief, the portion of the Technical Report for which I am responsible contains all scientific and technical information that is required to be disclosed to make the portion of the Technical Report for which I am responsible not misleading.
- 9) I am independent of the issuer applying all of the tests in section 1.5 of National Instrument 43-101.
- 10) I have read National Instrument 43-101 and Form 43-101F1, and the Technical Report has been prepared in compliance with that instrument and form.

Dated this 4th day of September, 2014

(signed) G. H. Giroux

[Sealed]

G. H. Giroux, P.Eng., M.A.Sc.

SABRY ABDEL HAFEZ, PH.D., P.ENG.

I, Sabry Abdel Hafez, Ph.D., P.Eng., of Vancouver, British Columbia, do hereby certify:

- I am a Senior Mining Engineer with Tetra Tech WEI Inc. with a business address at 800-555 West Hastings Street, Vancouver, British Columbia, V6B 4N6.
- This certificate applies to the technical report entitled “Preliminary Economic Assessment (PEA) NI 43-101 Technical Report on the Tiger Gold Project Yukon Territory, Canada”, dated September 04, 2014 (the “Technical Report”).
- I am a graduate of Assiut University, (B.Sc Mining Engineering, 1991; M.Sc. in Mining Engineering, 1996; Ph.D. in Mineral Economics, 2000). I am a member in good standing of the Association of Professional Engineers and Geoscientists of British Columbia (License #34975). My relevant experience is in mine evaluation. I have more than 20 years of experience in the evaluation of mining projects, advanced financial analysis, and mine planning and optimization. My capabilities range from the conventional mine planning and evaluation to the advanced simulation-based techniques that incorporate both market and geological uncertainties. I have been involved in the technical studies of several base metals, gold, coal, and aggregate mining projects in Canada and abroad. I have recently been involved in the technical reports for the NovaCopper’s Arctic project PEA study, SilverCrest’s La Joya project PEA study, Copper Fox’s Schaft Creek project feasibility study, Pretium Resources’ Brucejack project feasibility study, AQM’s Zafranal PEA study, Castle Resources’ Granduc project PEA study, Sabina’s Back River project prefeasibility study and Seabridge’s KSM project prefeasibility study. I am a “Qualified Person” for the purposes of National Instrument 43-101 (the “Instrument”).
- I completed a personal inspection of the Property on November 15th, 2013.
- I am responsible for Sections 1.7, all of 15, all of 16, 21.2, 21.7.1 and mining-related part of sections 25 and 26 of the Technical Report.
- I am independent of ATAC Resources Ltd. as defined by Section 1.5 of the Instrument.
- I have no prior involvement with the Property that is the subject of the Technical Report.
- I have read the Instrument and the sections of the Technical Report that I am responsible for have been prepared in compliance with the Instrument.
- As of the date of this certificate, to the best of my knowledge, information and belief, the sections of the Technical Report that I am responsible for contains all scientific and technical information that is required to be disclosed to make the Technical Report not misleading.

Signed and dated this 29th day of August, 2014 at Vancouver, British Columbia.

*“Original document signed and sealed by
Sabry Abdel Hafez, Ph.D., P.Eng.”*

Sabry Abdel Hafez, Ph.D., P.Eng.
Senior Mining Engineer
Tetra Tech WEI Inc.



Certificate of Qualified Person

I, Robert L. McIntyre, R.E.T., as an author of this report entitled "*Preliminary Economic Assessment (PEA) NI 43-101 Technical Report on the Tiger Gold Project, Yukon Territory, Canada*", prepared for ATAC Resources Ltd., effective as of July 23, 2014 and dated September 4, 2014, do hereby certify that:

- 1) I am the owner and Principal Consultant of Resource Strategies of Whitehorse, Yukon Territory, Canada;
- 2) I am a graduate of Sir Sandford Fleming College with a diploma as a Geological Technologist, 1979. I have practiced continuously in my profession since 1979, and have been continuously directly responsible for the environmental assessment and permitting numerous mines in Yukon since 1995 as an owner of Access Mining Consultants Ltd. and from 2006 to 2012 as Vice President of Alexco Resource Corp;
- 3) I am a Registered Engineering Technologist (No. 13728) in good standing since 1989 of the Association of Science and Engineering Technology Professionals of Alberta (ASET);
- 4) I have read the definition of "qualified person" set out in National Instrument 43-101 and certify that by reason of my education, past relevant work experience, independence and affiliation with a professional association, I meet the requirements of an Independent Qualified Person as defined in National Policy 43-101;
- 5) I have not visited the Tiger property;
- 6) I am one of the authors of this Technical Report, responsible for Section 20 and the relevant portions of Sections 1, 24, 26, and 27 regarding environmental considerations, permitting requirements and socioeconomic considerations;
- 7) I am independent of the Issuer applying the test set out in Section 1.5 of NI 43-101;
- 8) I have not had prior involvement with the property that is the subject of the Technical Report;
- 9) I have read NI 43-101, and the portion of the Technical Report for which I am directly responsible has been prepared in compliance with NI 43-101 and Form 43-101F1.
- 10) To the best of my knowledge and belief, the Technical Report contains all scientific and technical information that is required to be disclosed to make the technical report not misleading.

Dated this 4th day of September, 2014

Original signed by

Robert L. McIntyre, R.E.T.

Resource Strategies, Whitehorse, Yukon Territory

GERALD G. CARLSON, PH.D., P.ENG.

I, Gerald G. Carlson, Ph.D., P.Eng, as an author of this report entitled "Preliminary Economic Assessment (PEA) NI 43-101 Technical Report on the Tiger Gold Project, Yukon Territory, Canada", prepared for ATAC Resources Ltd., effective as of July 23, 2014 and dated September 4, 2014, do hereby certify that:

1. I am a consulting mineral exploration geologist residing at 1740 Orchard Way, West Vancouver, B.C. V7V 4E8.
2. I am a graduate of the University of Toronto, with a degree in Geological Engineering (B.A.Sc., 1969). I attended graduate school at Michigan Technological University (M.Sc., 1974) and Dartmouth College (Ph.D., 1978).
3. I am a member in good standing of the Association of Professional Engineers and Geoscientists of the Province of British Columbia, Registration No. 12513 and of the Association of Professional Engineers of Yukon, Registration No. 0198. I have been involved in geological mapping, mineral exploration and the management of mineral exploration companies continuously since 1969, with the exception of time between 1972 and 1978 for graduate studies in economic geology. I am a "Qualified Person" for the purposes of NI 43-101 by reason of my education, affiliation with a professional association as defined by NI 43-101 and past relevant work experience.
4. I have read the definition of "qualified person" set out in National Instrument 43-101 (NI 43-101) and certify that by reason of my education, affiliation with a professional association (as defined in NI 43-101) and past relevant work experience, I fulfill the requirements to be a "qualified person" for the purposes of NI 43-101.
5. I have visited the Tiger Project Property.
6. I am one of the authors of this Technical Report, responsible for preparation of Sections 4, 5, 6, 7, 8, 9, 10, 11, 12, and 23 of the report.
7. I am independent of the Issuer applying the test set out in Section 1.5 of NI 43-101.
8. I have not had prior involvement with the property that is the subject of the Technical Report.
9. I have read NI 43-101, and the Technical Report has been prepared in compliance with NI 43-101 and Form 43-101F1.
10. As of the date of this certificate, to the best of my knowledge, information and belief, the portion of the Technical Report for which I am responsible contains all scientific and technical information that is required to be disclosed to make the Technical Report not misleading.

Dated this 4th day of September, 2014

Original Signed by

Gerald G. Carlson, Ph.D., P.Eng.