

MAP NO.: ASSESSMENT REPORT X
105 D 4 PROSPECTUS X
CONFIDENTIAL X
OPEN FILE

DOCUMENT NO: 092767
MINING DISTRICT: Whitehorse
TYPE OF WORK: Blast trenching

REPORT FILED UNDER: Aurum Geological Consultants Inc.

DATE PERFORMED: 4 August-1 September, 1989 DATE FILED: 20 November, 1989

LOCATION: LAT.: 60°11'N AREA: Mt Skukum
LONG.: ~~137°30'W~~ 135°30' VALUE \$:

CLAIM NAME & NO.: EARL 1-32 (YA77293-324); PLUS 1-10 FR; PLUS 100

WORK DONE BY: R. Hulstein

WORK DONE FOR: Northern Minerals Ltd

DATE TO GOOD STANDING:	REMARKS: #229 EARL
	Seven blast trenches were excavated on the property in 1989, exposing
	a graphitic shear zone which appears to be a northward extension of
	the CHARLESTON vein system. Quartz veins in the shear zone were chip
	sampled. The best result was a 0.5m chip sample which assayed 2558
	ppb Au and 193.9 ppm Ag.



AURUM GEOLOGICAL CONSULTANTS INC.



November 17, 1989

Mr. R. H. Whittingham
Mining Recorder
Room 201, Federal Building
Whitehorse, Yukon
Y1A 2B5

Dear Mr. Whittingham;

Re: Earl 1 - 32, Plus 1 - 10Fr. and Plus 100 claim renewals, 105D/4,
Whitehorse Mining District.

Please find enclosed a cheque to the amount of \$830.00 to renew the Earl 1 - 32 for 5 years. The results of the 1989 hand trenching program (assessment work) and invoices for the work are also included.

On August 31, 1989, we applied to renew the Plus 1 - 10Fr. and Plus 100 claims for 5 years with a report to follow. I trust the data on the trenching program will suffice as a report on the 1989 program.

Yours Sincerely
Aurum Geological Consultants Inc.

Roger Hulstein, partner

*Approved as physical work Dec/89
Report not required*

092767

412
604-675 West Hastings Street,
Vancouver, B.C.,
Canada V6B 1N2
Tel: (604) 683-9656
Fax: (604) 683-7625

P.O. Box 5179,
Whitehorse, Yukon,
Canada Y1A 4S3
Tel: (403) 667-4168
Fax: (403) 668-2021

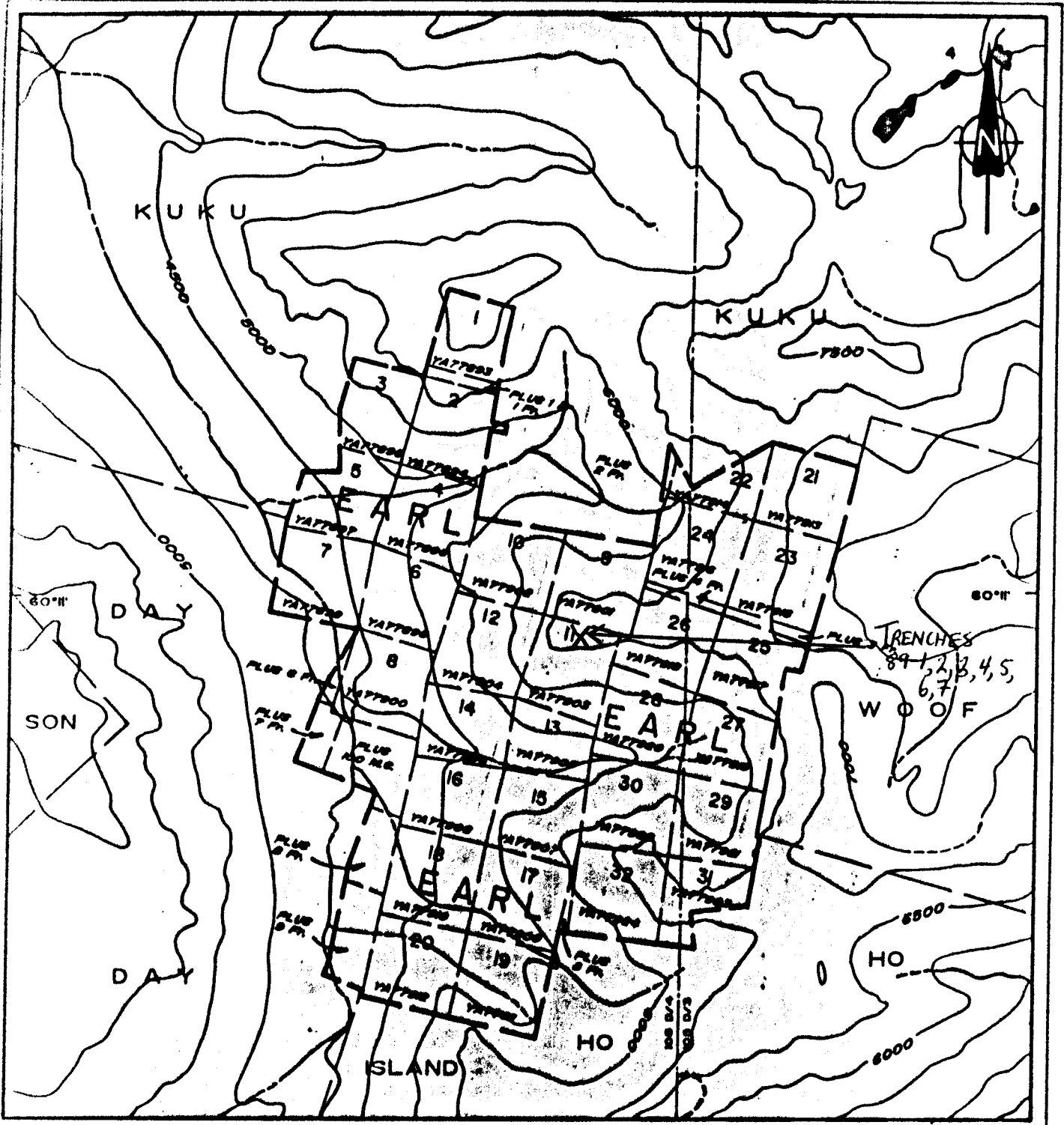

LEGEND

- ← claim boundary
- ← claim number
- ← tag number
- ← 4WD trail
- ← creek, lake
- ← elevation contour; interval 500 ft.

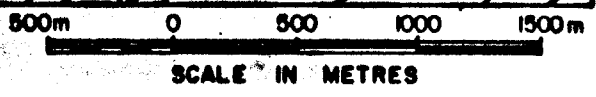

NORTHERN MINERALS LTD	
EARL CLAIMS WHITEHORSE MINING DISTRICT	
CLAIM MAP	
Aurum Geological Consultants Inc.	OCTOBER 1989
NTS 108 D/344	DRAWN BY NH SCALE 1:30,000 FIGURE 2

Note: adapted from D.I.A.N.D. map sheets
105 D-3 & 105 D-4



Sample Number	TRENCH GEOCHEMISTRY		Au ppb	Ag ppm
	Sample Type			
9816501	Chip 1 m		20	11.2
9816502	Chip 1 m		7	<0.1
9816503	Chip 1 m		16	1.3
9816504	Chip 1 m		22	<0.1
9816505	Chip 1 m		46	0.4
9816506	Chip 1 m		7	0.4
9816507	Chip .5 m		61	0.8
9816508	Chip 1 m		15	1.8
9810003	Grab		24	2.0
9820006	Grab		1913	5.6
9866501	soil		1406	34.7
9866502	soil		165	2.2
9866503	soil		1383	41.0
9866504	soil		141	4.4
9866505	soil		217	4.9

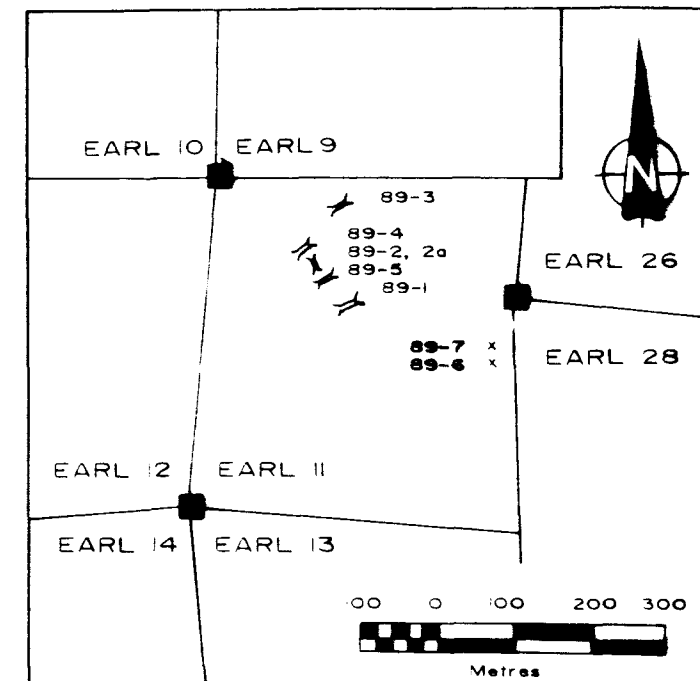

TRENCH LOCATION MAP

LEGEND

LITHOLOGIES

PROTEROZOIC(?) TO PALEOZOIC(?)
NISLING TERRANE

- PPNs** PHYLLITE, QUARTZITE, QUARTZ-FELDSPAR-BIOTITE (GARNET) SCHIST, MARBLE, SKARN, AND MINOR AMPHIBOLITE
- PPNd** PHYLLITE, LOCALLY GRAPHITIC
- PPNq** QUARTZITE

SYMBOLS

- GEOLOGICAL CONTACT (defined, assumed)
- 50I CHIP SAMPLE (ALL SAMPLES BEGIN WITH 986...)
- x 9820006 GRAB SAMPLE
- 0 8264245 SOIL SAMPLE COLLECTED IN 1988
- TRENCH CUT
- OUTCROP
- ~ SHEARING
- ~ FAULT
- ||||| QUARTZ VEIN (METAMORPHIC), INCLINED
- 1/50 FOLIATION, INCLINED
- 9866501 SOIL SAMPLE
- lim LIMONITE

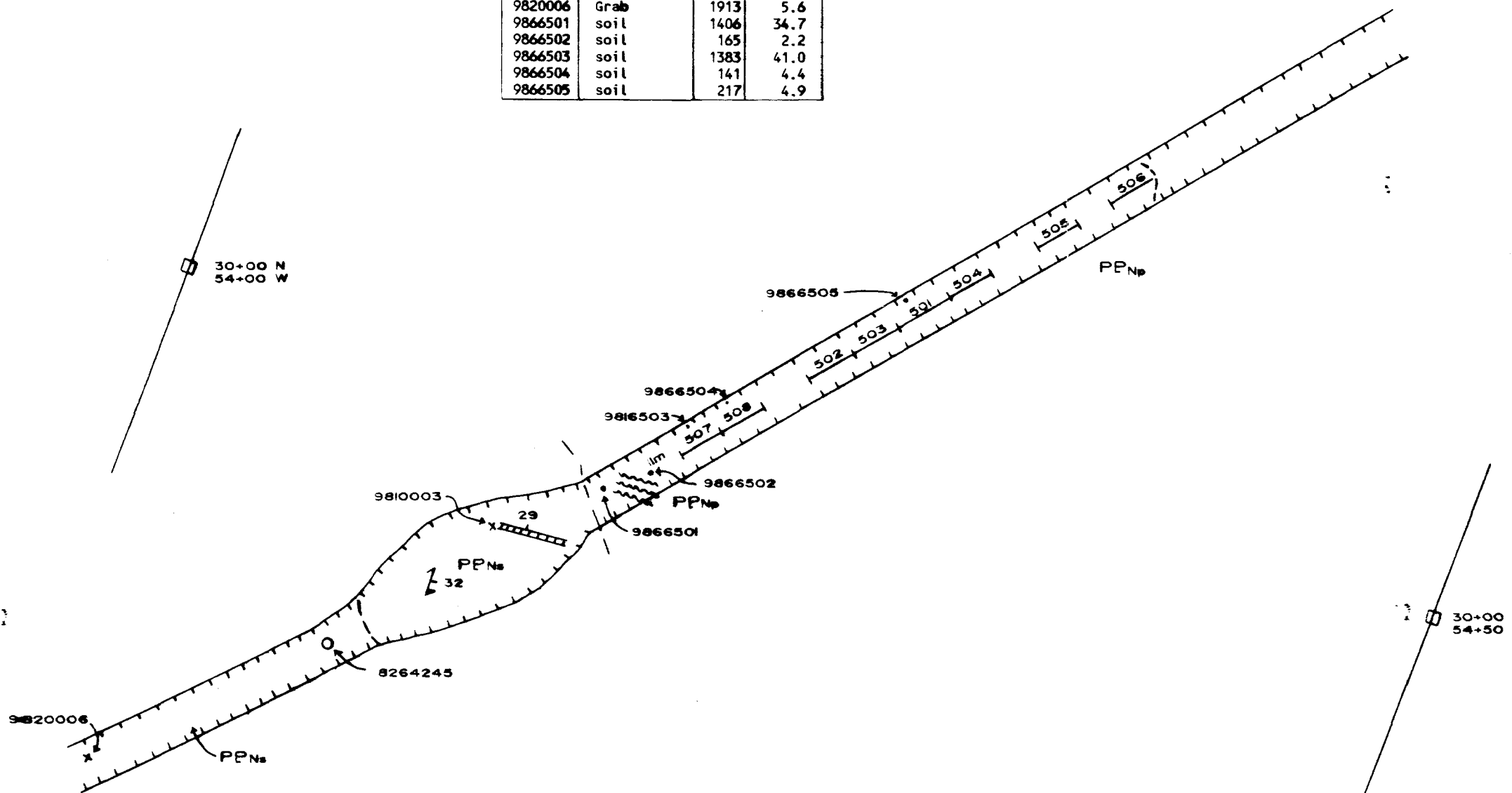

VOLUME

TRENCH 89-1:
30M X 1M X 1.5M = 45 CUBIC METRES

• TRENCH 89-1 IS FORMERLY TRENCH 88-1



NORTHERN MINERALS LTD.	
EARL CLAIMS WHITEHORSE MINING DISTRICT	
TWIST ZONE	
TRENCH 89-1	
Aurum Geological Consultant's Inc	SEPT. 1989
NTS:105D/4	Drawn By: LW/LK
SCALE: 1:100	FIGURE: 6

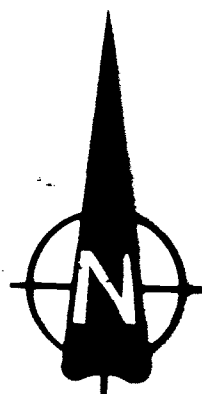

TRENCH GEOCHEMISTRY			
Sample Number	Sample Type	Au ppb	Ag ppm
9810501	Chip 1 m	58	2.1
9810502	Chip 1 m	326	4.7
9810503	Chip 1 m	462	6.1
9810504	Chip 1 m	202	7.1
9810505	Chip 1 m	127	4.8
9810506	Chip 1 m	1318	15.8
9810507	Chip .5 m	1625	17.0
9810508	Chip .5 m	73	2.7
9810509	Grab 1 m	10	2.8
9820500	Grab	39	1.0
9860500	soil	47	2.1
9860501	soil	173	2.6

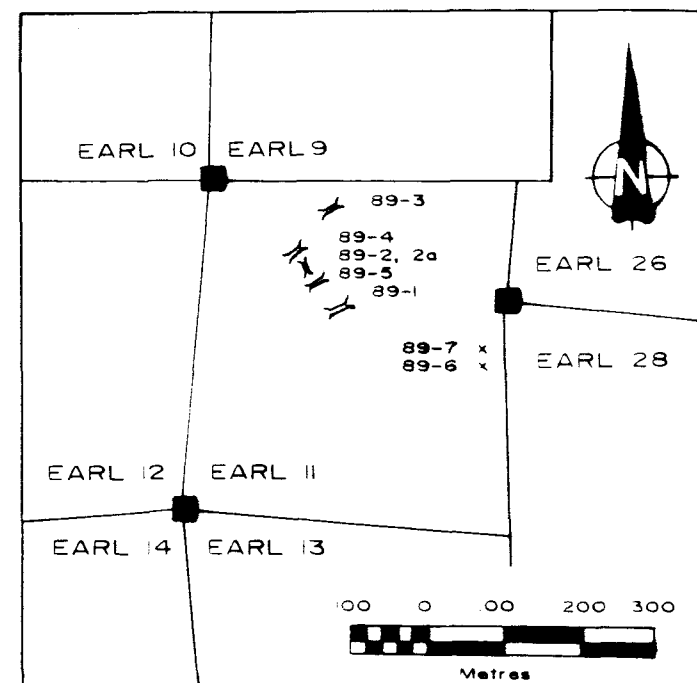

TRENCH LOCATION MAP

LEGEND

LITHOLOGIES

PROTEROZOIC(?) TO PALEOZOIC(?)
NISLING TERRANE

- PPNS** PHYLITE, QUARTZITE, QUARTZ-FELDSPAR-BIOTITE (GARNET) SCHIST, MARBLE, SKARN, AND MINOR AMPHIBOLITE
- PPNd** PHYLITE, LOCALLY GRAPHITIC
- PPNq** QUARTZITE

SYMBOLS

- VEIN ZONE/WALL ROCK CONTACT (defined, assumed)
- CHIP SAMPLE (ALL SAMPLES BEGIN WITH 9810...)
- 9820500 GRAB SAMPLE
- 9860500 SOIL SAMPLE
- METAMORPHIC QUARTZ
- 30 VEIN ZONE DIP
- 57 FAULT, INCLINED
- 78 FOLIATION, INCLINED
- TRENCH CUT
- OUTCROP
- clay CLAY
- lim LIMONITE

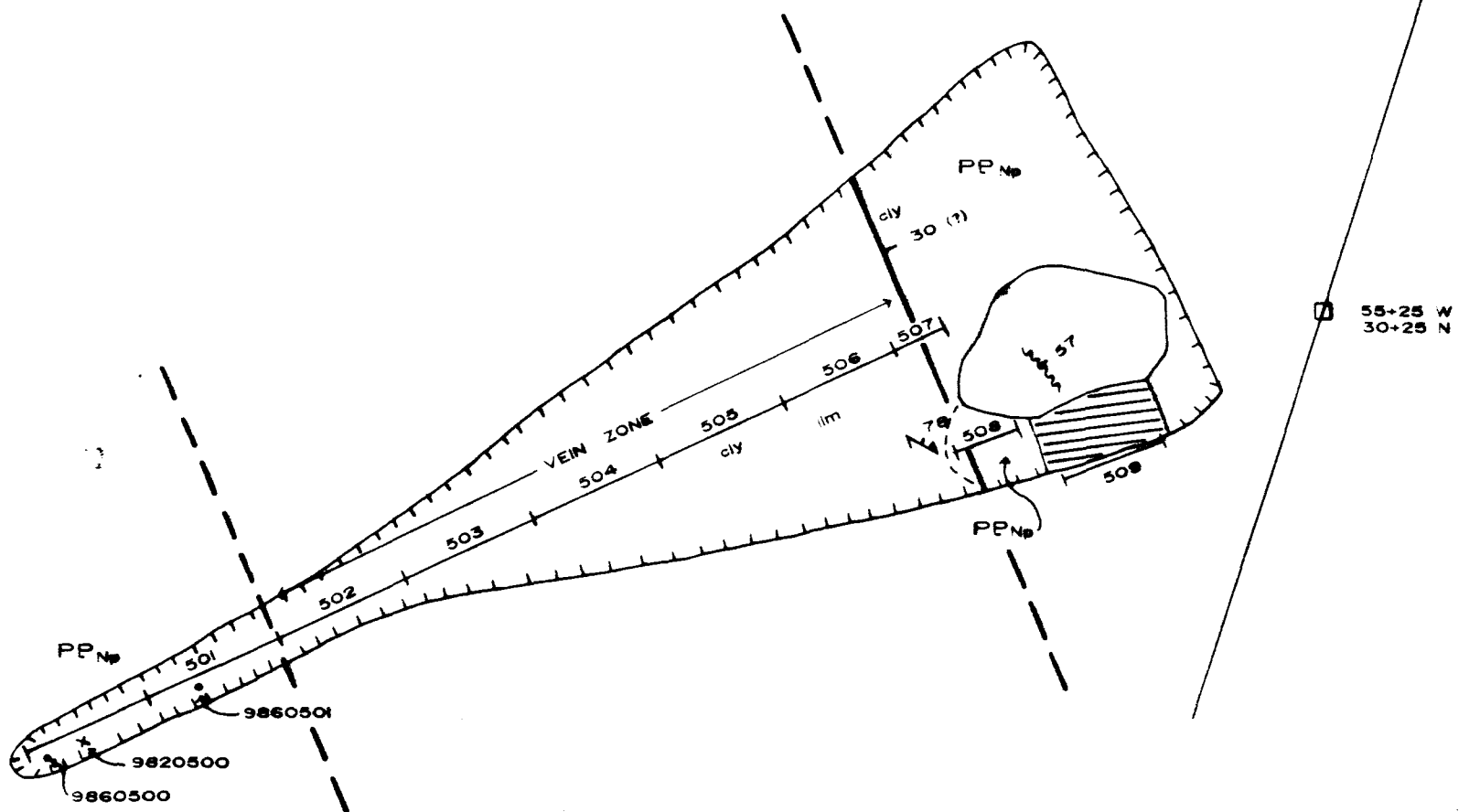

VOLUME

TRENCH 89-2a:
9M X 1.5M X 2M = 27 CUBIC METRES

- * TRENCH 89-2a IS FORMERLY TRENCH 88-2
- * TRENCH 89-2a IS TRENCH 89-2 BEFORE EXPANSION

NORTHERN MINERALS LTD.

EARL CLAIMS
WHITEHORSE MINING DISTRICT

TWIST ZONE

TRENCH 89-2a

Aurum Geological Consultants Inc SEPT. 1989

NTS:105D/4 Drawn By: LW/LK SCALE: 1:50 FIGURE: 7



TRENCH GEOCHEMISTRY			
Sample Number	Sample Type	Au ppb	Ag ppm
9810550	Chip 1 m	112	9.3
9810551	Chip .5 m	75	8.2
9810552	Chip .5 m	544	5.5
9810553	Chip 1 m	156	10.3
9810554	Chip .7 m	197	21.1
9810555	Chip 1 m	420	13.9
9810556	Chip 1 m	161	5.1
9810557	Chip 1 m	280	6.6
9810558	Chip 1 m	827	77.4
9810559	Chip .5 m	2558	193.9
9810560	Chip 1 m	450	6.7
9810561	Chip .5 m	1759	18.1
9810562	Chip .8 m	986	6.5
9810563	Chip .2 m	134	17.6
9810565	Chip .5 m	413	5.6
9810566	Chip 1 m	303	12.2
9810567	Chip .4 m	52	3.2
9810568	Chip .8 m	804	23.5
9810569	Chip .6 m	373	3.3
9810570	Chip .5 m	289	6.7
9810571	Chip .7 m	1002	14.4

TRENCH GEOCHEMISTRY			
Sample Number	Sample Type	Au ppb	Ag ppm
9810572	Chip .7 m	276	7.8
9810573	Chip .6 m	475	10.1
9810574	Chip .7 m	211	4.4
9810575	Chip .5 m	279	4.6
9810576	Chip .8 m	157	10.2
9810577	Chip .6 m	258	11.0
9810578	Chip .8 m	420	9.2
9810579	Chip .8 m	1060	250.4
9810580	Chip .6 m	338	28.2
9810581	Chip .5 m	220	6.9
9810582	Chip .3 m	255	15.5
9810583	Chip 1 m	445	15.1
9810584	Chip 1 m	357	12.6
9810585	Chip .8 m	429	4.3
9810586	Grab	59	3.1
9810587	Chip .5 m	893	14.8
9810588	Chip .8 m	483	2.8
9810589	Chip .5 m	1060	1.5
9816520	Chip .5 m	241	5.4
9816521	Chip .5 m	617	7.0
9810510	Composite	390	0.6
9820501	Grab	83	1.4

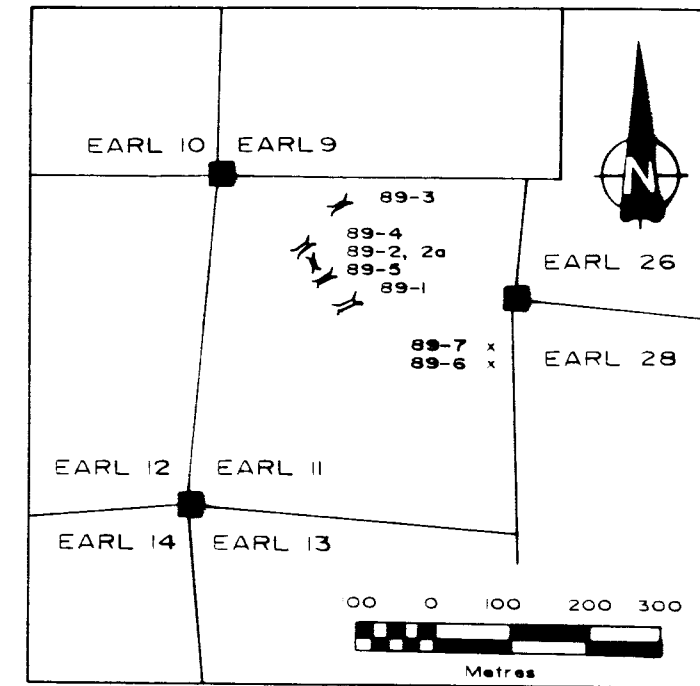

TRENCH LOCATION MAP
LEGEND

LITHOLOGIES

PROTEROZOIC(?) TO PALEOZOIC(?)
NISLING TERRANE

- PENS** PHYLLITE, QUARTZITE, QUARTZ-FELDSPAR-BIOTITE (GARNET) SCHIST, MARBLE, SKARN, AND MINOR AMPHIBOLITE
- PP_{np}** PHYLLITE, LOCALLY GRAPHITIC
- PP_{nq}** QUARTZITE

SYMBOLS

- VEIN ZONE / WALL ROCK CONTACT (defined, assumed)
- GEOLOGICAL CONTACT (defined, assumed)
- CHIP SAMPLE (ALL SAMPLES BEGIN WITH 98105, UNLESS FULL NUMBER IS GIVEN)
- GRAB SAMPLE
- SHEARING
- FAULT
- FOLIATION, INCLINED
- TRENCH CUT
- METAMORPHIC QUARTZ
- OUTCROP
- qtz** quartz
- sc** scapolite
- tt** tetrahedrite
- HW** Hangingwall
- ilm** ilmenite
- gn** garnet
- cl** clay
- mal** malachite
- py** pyrite

VOLUME

TRENCH 89-2:
14M X 5M X 2M = 140 CUBIC METRES

* TRENCH 89-2 IS FORMERLY TRENCH 88-2

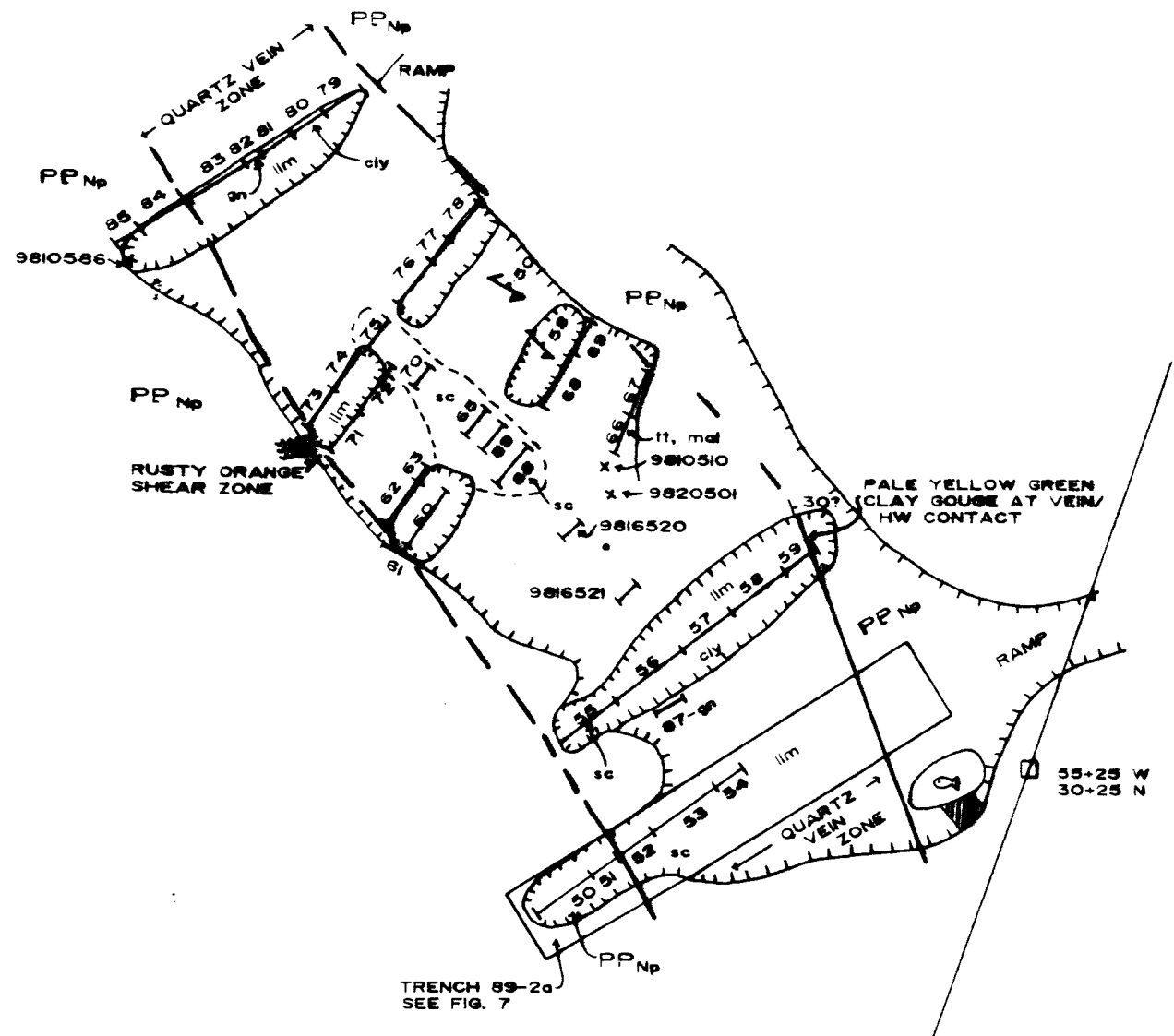

TRENCH 89-2a
SEE FIG. 7

NORTHERN MINERALS LTD.	
EARL CLAIMS WHITEHORSE MINING DISTRICT	
TWIST ZONE	
TRENCH 89-2	
Aurum Geological Consultants Inc	SEPT. 1989
NTS:1050/4	Drawn By: LW/LK SCALE: 1:100 FIGURE: 8

TRENCH GEOCHEMISTRY				
Sample Number	Sample Type		Au ppb	Ag ppm
9816511	Chip 1 m		29	0.9
9816512	Chip 1 m		21	0.2
9816513	Chip 1 m		17	0.2
9816514	Chip 1 m		14	0.7
9866569	Soil		190	1.9
9866570	Soil		174	0.8
9866571	Soil		48	0.1
9866572	Soil		82	0.3

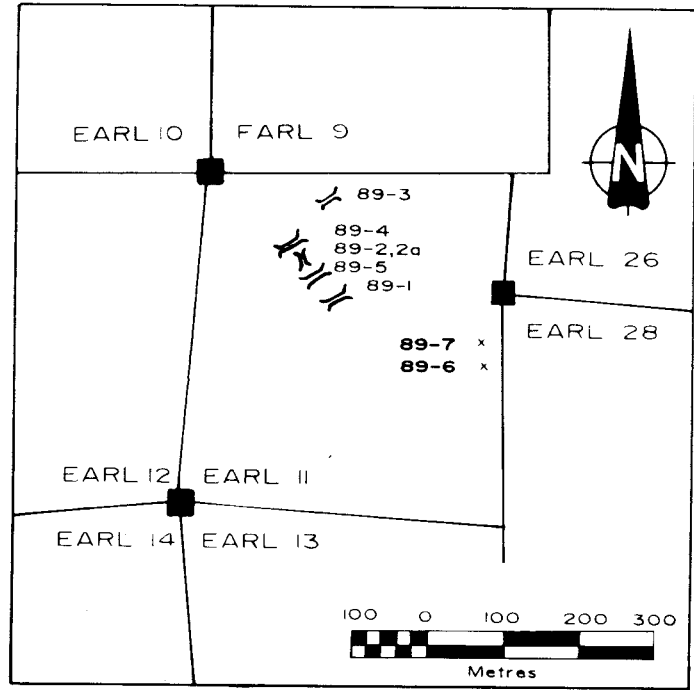

TRENCH LOCATION MAP

LEGEND

LITHOLOGIES

PROTEROZOIC(?) TO PALEOZOIC(?)
NISLING TERRANE

- PPNs** PHYLLITE, QUARTZITE, QUARTZ-FELDSPAR-BIOTITE (GARNET) SCHIST, MARBLE, SKARN AND MINOR AMPHIBOLITE
- PP_{Np}** PHYLLITE, LOCALLY GRAPHITIC
- PP_{Nq}** QUARTZITE

SYMBOLS

- ||** CHIP SAMPLE (ALL SAMPLE NUMBERS BEGIN WITH 9816...)
- 9866569 SOIL SAMPLE

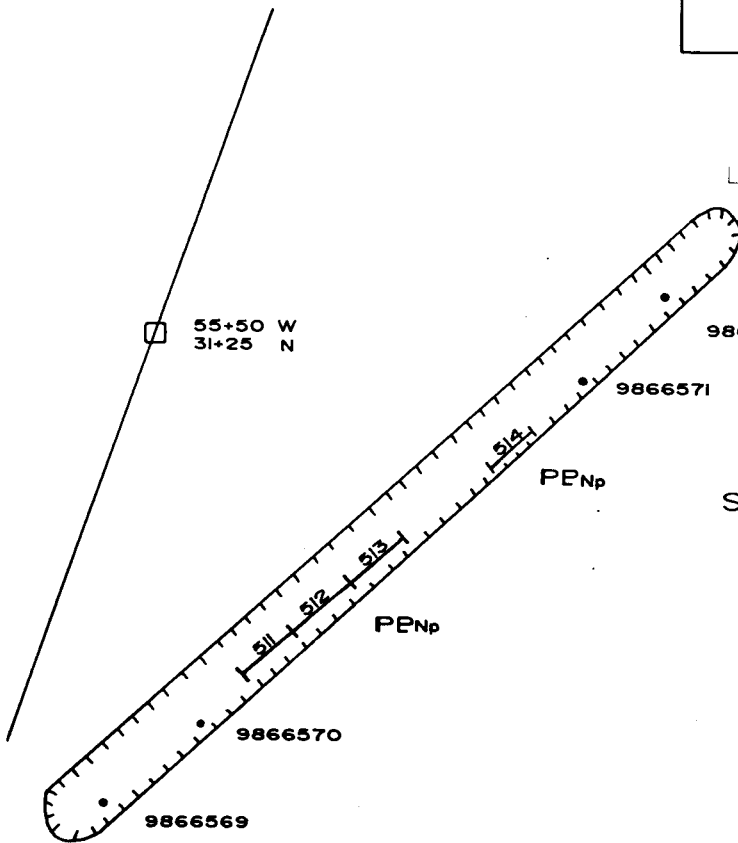

VOLUME

TRENCH 89-3:
12M X 0.8M X 1.5M = 14.4 CUBIC METRES



NORTHERN MINERALS LTD.	
EARL CLAIMS WHITEHORSE MINING DISTRICT	
TWIST ZONE	
TRENCH 89-3	
Aurum Geological Consultants Inc.	SEPT. 1989
NTS:1050/4	Drawn By: LW/LK
SCALE: 1:100	FIGURE: 9



TRENCH GEOCHEMISTRY			
Sample Number	Sample Type	Au ppb	Ag ppm
9816526	Chip .4 m	26	3.1
9816527	Chip .3 m	13	3.1
9816528	Chip .5 m	42	3.8
9816529	Chip .9 m	33	3.1
9816530	Chip 1 m	10	2.5
9816531	Chip 1 m	<5	2.1
9816532	Chip 1 m	<5	3.3
9816533	Chip .7 m	5	1.1
9816534	Chip 1 m	<5	1.9
9816535	Chip .6 m	39	3.2
9816536	Grab	35	3.3
9816537	Chip .8 m	20	4.7
9816538	Chip .8 m	12	3.2
9816539	Grab	71	4.1

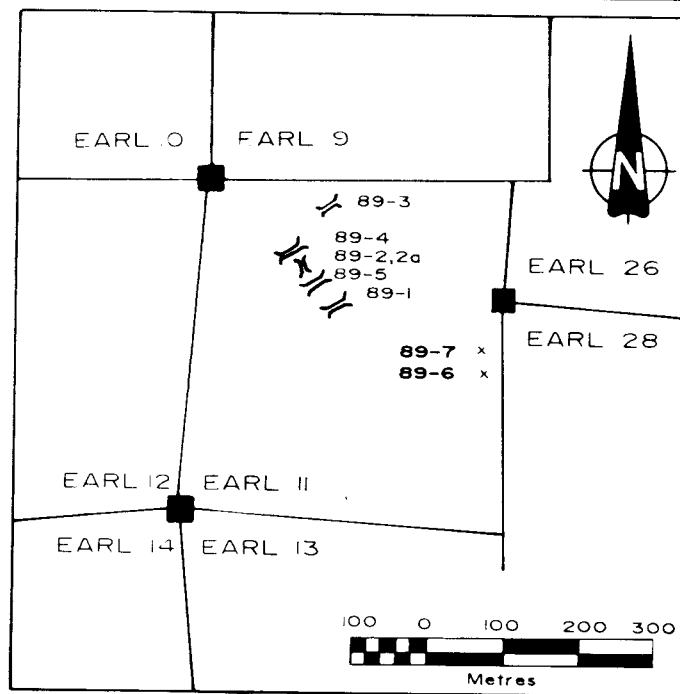

TRENCH LOCATION MAP

LEGEND

LITHOLOGIES

PROTEROZOIC(?) TO PALEOZOIC(?)
NISLING TERRANE

- PPNS** PHYLLITE, QUARTZITE, QUARTZ-FELDSPAR-BIOTITE (GARNET) SCHIST, MARBLE, SKARN AND MINOR AMPHIBOLITE
- PPNp** PHYLLITE, LOCALLY GRAPHITIC
- PPNq** QUARTZITE

SYMBOLS

- CHIP SAMPLE (ALL SAMPLE NUMBERS BEGIN WITH 9816...)
- x 9816536** GRAB SAMPLE
- FAULT
- GEOLOGICAL CONTACT (defined, assumed)
- SHEAR ZONE
- TRENCH CUT
- OUTCROP
- llm** LIMONITE

VOLUME

TRENCH 89-4:
 4M X 4M X 1.5M = 24 CUBIC METRES
 1.5M X 1M X 1.5M = 2.3 CUBIC METRES
 TOTAL VOLUME = 26.3 CUBIC METRES

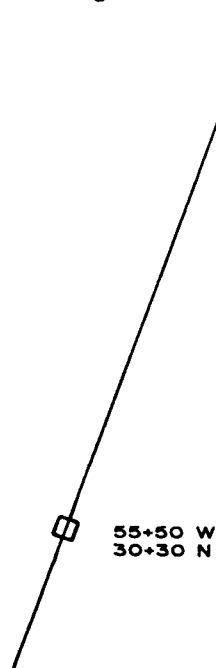
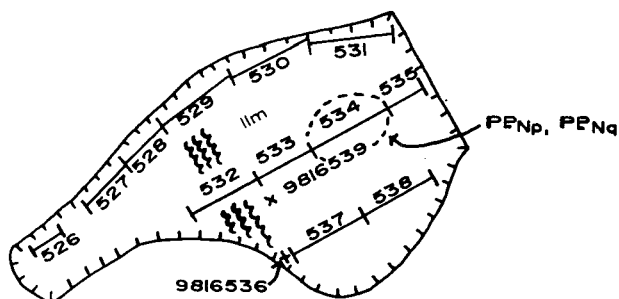

NORTHERN MINERALS LTD.	
EARL CLAIMS WHITEHORSE MINING DISTRICT	
TWIST ZONE	
TRENCH 89-4	
Aurum Geological Consultants Inc.	SEPT. 1989
NTS:105D/4	Drawn By: LW/LK
SCALE: 1:100	FIGURE: 10



TRENCH GEOCHEMISTRY			
Sample Number	Sample Type	Au ppb	Ag ppm
9816522	Grab	37	0.2
9816523	Chip .2 m	41	0.5
9816524	Grab	38	0.9
9816525	Chip .4 m	23	0.8

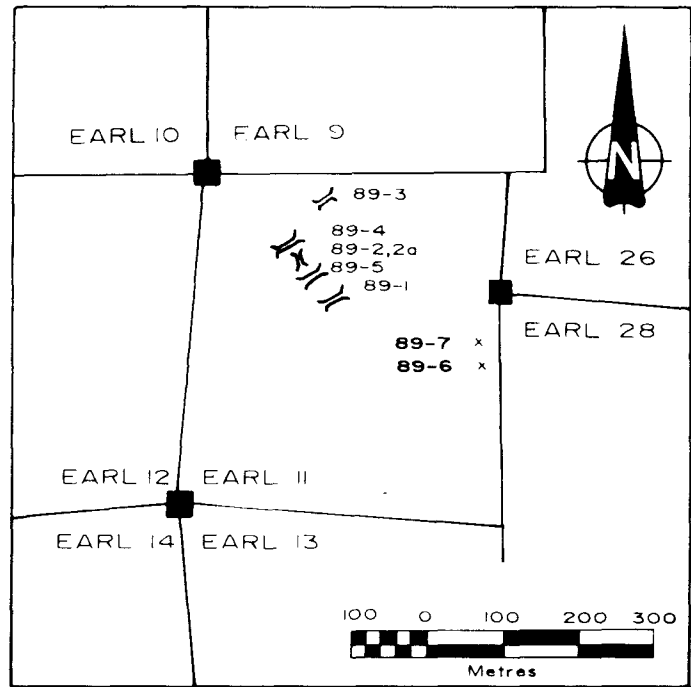

TRENCH LOCATION MAP

LEGEND

LITHOLOGIES

PROTEROZOIC(?) TO PALEOZOIC(?)
NISLING TERRANE

- PPNs** PHYLLITE, QUARTZITE, QUARTZ-FELDSPAR-BIOTITE (GARNET) SCHIST, MARBLE, SKARN AND MINOR AMPHIBOLITE
- PPNp** PHYLLITE, LOCALLY GRAPHITIC
- PPNq** QUARTZITE

SYMBOLS

- GEOLOGICAL CONTACT (defined, assumed)
- 523** CHIP SAMPLES (ALL SAMPLE NUMBERS BEGIN WITH 9816...)
- x 9816524** GRAB SAMPLE
- |||||** TRENCH CUT

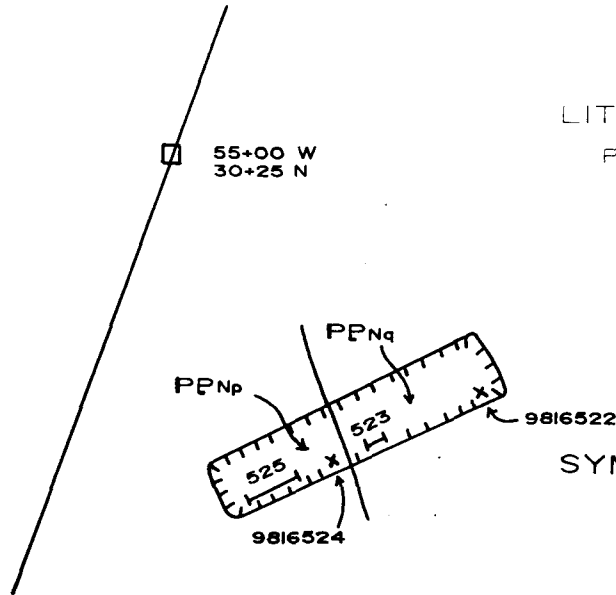

VOLUME

TRENCH 89-5:
4M X 1M X 1.5M = 6 CUBIC METRES



NORTHERN MINERALS LTD.			
EARL CLAIMS WHITEHORSE MINING DISTRICT			
TWIST ZONE			
TRENCH 89-5			
Aurum Geological Consultants Inc.		SEPT. 1989	
NTS:105D/4	Drawn By: LW/LK	SCALE: 1:100	FIGURE: II



TRENCH GEOCHEMISTRY			
Sample Number	Sample Type	Au ppb	Ag ppm
9816515	Chip 1 m	147	3.2
9816516	Chip 1 m	173	1.5
9816517	Chip 1 m	398	2.2
9816518	Chip 1 m	86	0.1
9816519	Chip 1 m	276	0.9

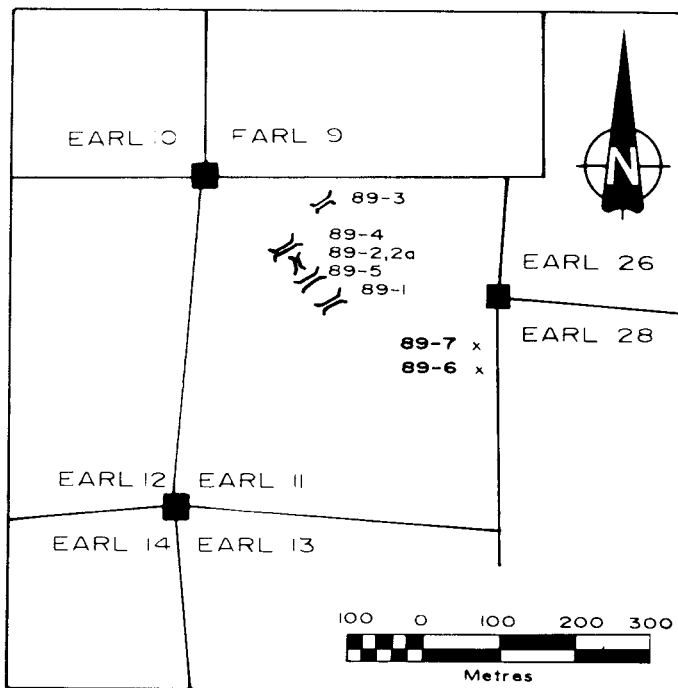

TRENCH LOCATION MAP

LEGEND

LITHOLOGIES

PROTEROZOIC(?) TO PALEOZOIC(?)
NISLING TERRANE

- PPNs** PHYLLITE, QUARTZITE, QUARTZ-FELDSPAR-BIOTITE (GARNET) SCHIST, MARBLE, SKARN AND MINOR AMPHIBOLITE
- PP_{Np}** PHYLLITE, LOCALLY GRAPHITIC
- PP_{Nq}** QUARTZITE

SYMBOLS

- GEOLOGICAL CONTACT (defined, assumed)
- CHIP SAMPLES (ALL SAMPLES BEGIN WITH 9816...)
- SHEARING

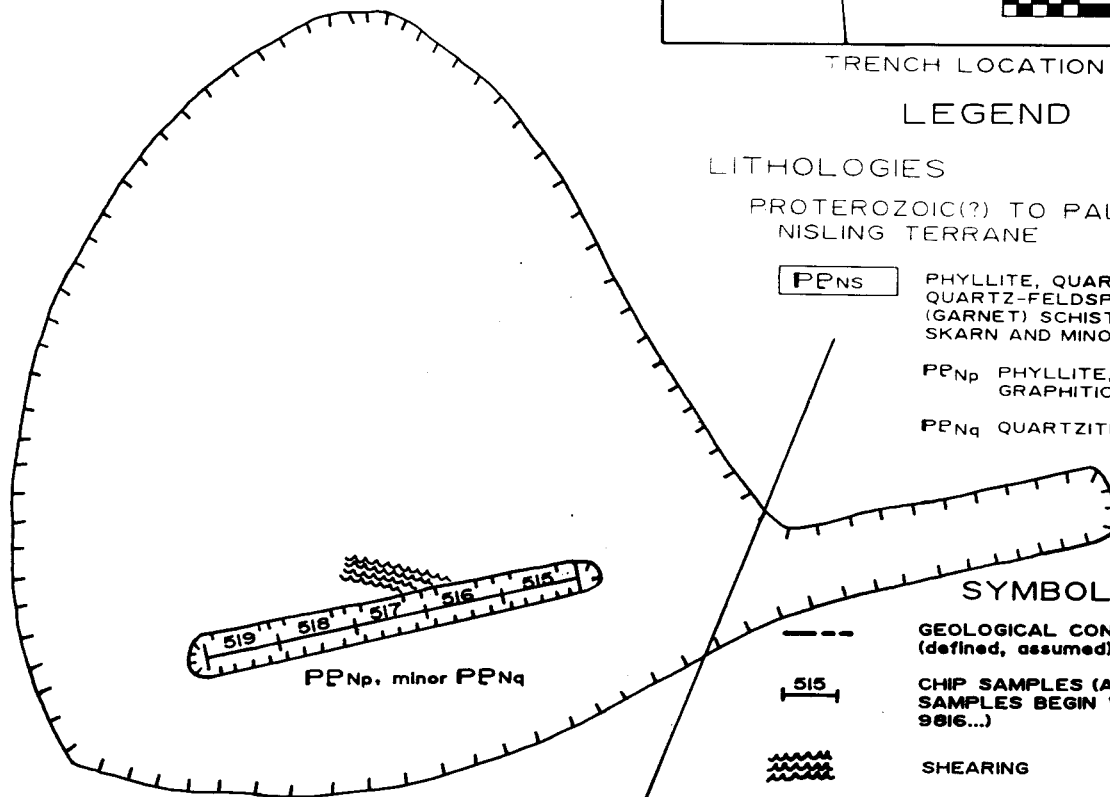

VOLUME

TRENCH 89-6:

10M X 5M X 1.5M = 75 CUBIC METRES
 5M X 1M X 1.5M = 7.5 CUBIC METRES
 TOTAL VOLUME = 82.5 METRES

52+25W
29+50N



NORTHERN MINERALS LTD.	
EARL CLAIMS WHITEHORSE MINING DISTRICT	
TWIST ZONE	
TRENCH 89-6	
Aurum Geological Consultants Inc.	SEPT. 1989
NTS:105D/4	Drawn By: LW/LK
SCALE: ± 100	FIGURE: 12



TRENCH GEOCHEMISTRY			
Sample Number	Sample Type	Au ppb	Ag ppm
9826505	Grab/Float	8	0.5
9826506	Grab/Float	<5	0.6

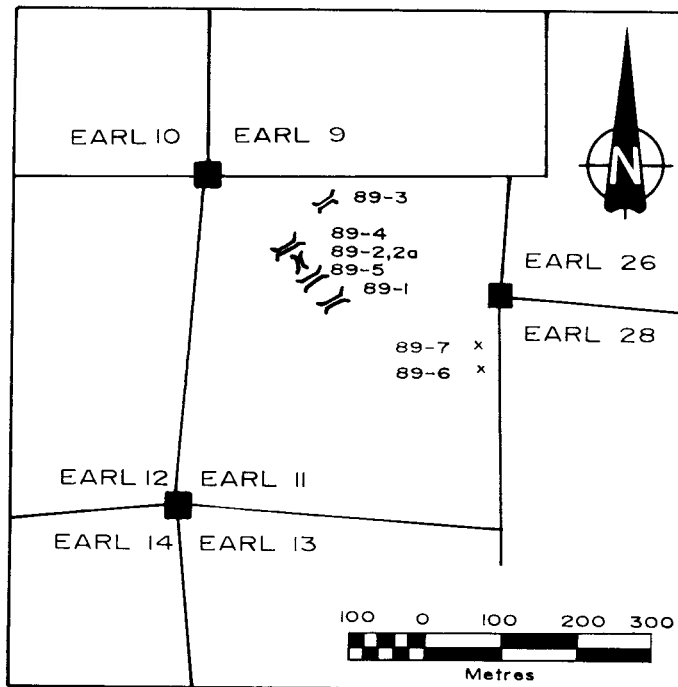

TRENCH LOCATION MAP

LEGEND

LITHOLOGIES

PROTEROZOIC(?) TO PALEOZOIC(?)
NISLING TERRANE

- PPNs** PHYLLITE, QUARTZITE, QUARTZ-FELDSPAR-BIOTITE (GARNET) SCHIST, MARBLE, SKARN AND MINOR AMPHIBOLITE
- PPNp** PHYLLITE, LOCALLY GRAPHITIC
- PPNq** QUARTZITE

SYMBOLS

- TRENCH CUT
- x 9826505** GRAB SAMPLE

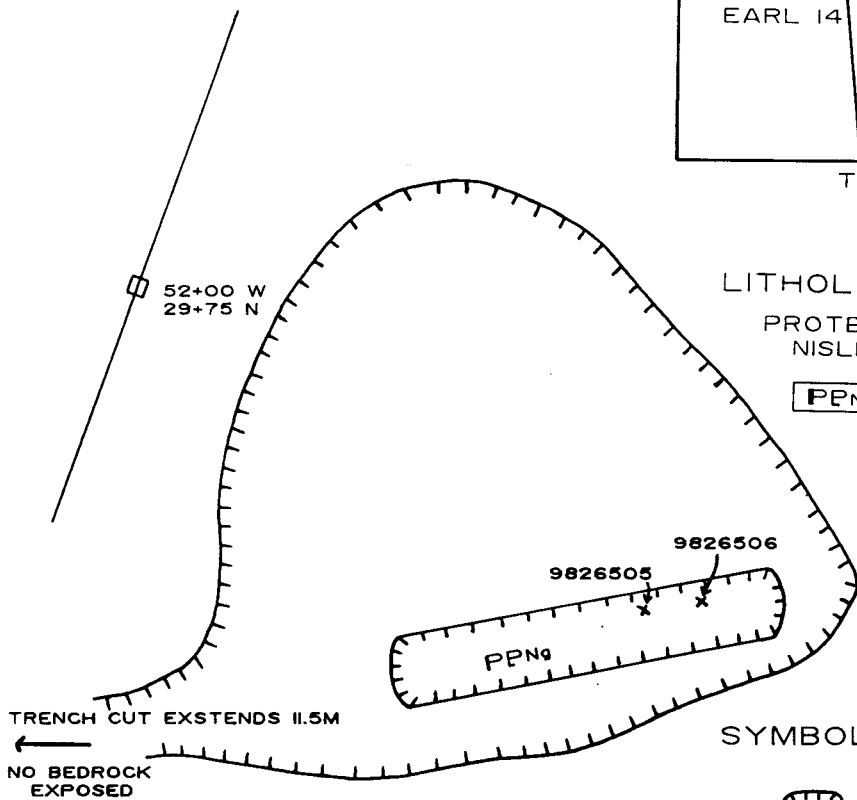

VOLUME

TRENCH 89-7:

7M X 5M X 1.5M = 52.5 CUBIC METRES
 11.5M X 1M X 1.5M = 17.25 CUBIC METRES
 TOTAL VOLUME: 69.75 CUBIC METRES



NORTHERN MINERALS LTD.	
EARL CLAIMS WHITEHORSE MINING DISTRICT	
TWIST ZONE	
TRENCH 89-7	
<i>Aurum Geological Consultants Inc.</i>	SEPT. 1989
NTS:105D/4	Drawn By: LW/LK
SCALE: 1:100	FIGURE: 13

INVOICE 25, 1989

Aug 29

MINIMUM GEOLOGICAL CONSULTANTS INC
P.O. Box 5179
WHITEHORSE, YUKON

INVOICE

REF: TRENCHING
EARL'S CLAIMS
MADLINT SKUKUB AREA, MAD 10510-3

THIS INVOICE YOU FOR:

4 DAYS X \$450.00 PER	\$1,800.00
7 DAYS X \$700.00 PER	\$4,900.00
PUMP RENTALS	
5 DAYS X \$15.00 PER	\$75.00
CAMP	
12 DAYS X \$10.00 PER	\$120.00
DIESEL	\$25.80
BLASTING SUPPLIES	\$3,175.71
COST + 15% _____	\$3,750.75
	<u>\$10,645.75</u>

WORK PERIOD: AUG 4 TO AUG 15/89

THANK YOU

[Signature]

M.J. MOREAU ENTERPRISES LTD.

Office: #21 - 4078 - 4th Avenue, Whitehorse, Yukon Bus. Phone: (403) 667-7067 Res. Phone: (403) 633-2541
Mailing Address: P.O. Box 8262, Whitehorse, Yukon, Y1A 4Z2

September 5, 1989

Aurum Geological Consultants Inc.
P.O. Box 5179
Whitehorse, Yukon

I N V O I C E

Re: Trenching
Earl claims Map 105 D/3
Mount Skukum area

To invoice you for:

2 days at \$450.00/day:	\$ 900.00
1 day at \$700.00/day:	700.00
4 days at \$950.00/day:	3,800.00
7 days at \$1,200.00/day:	<u>8,400.00</u>
	\$ 13,800.00
Camp: 14 days x \$10.00/day:	\$ 140.00
Pump: 12 days x \$15.00/day:	180.00
Blasting supplies \$ 2,064.94 + 15%:	<u>2,374.68</u>
Total Invoice:	<u>\$ 16,613.68</u>

Work period: August 16 - September 1, 1989

Thank you,

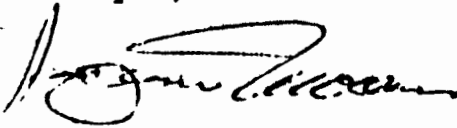
M.J. Moreau
SSS/cth